

# OLYMPUS M-1

The name "M-1" will be changed in future due to the trademark registration reason.

NEW NAME

**OLYMPUS  
OM-1**



# OLYMPUS M-1







## **Design philosophy of the M-system**

After spending five years and very large sums on research and development, Olympus has created a very remarkable new system camera, the M-1. It is a complete system for advanced amateur, professional or scientist providing an astonishing variety of photographic applications, ranging from candid photography all the way to Photomicrography.

The heart of the system is the M-1. It is a 35mm Single Lens Reflex camera featuring the highest performance, extreme reliability, very compact size and a most extensive range of accessory units. To achieve this combination of attributes, a surprisingly large number of the components in the M-1 are based on innovative Olympus engineering. In designing a new SLR camera, Olympus was very conscious of the basic failings of the conventional SLR camera, as reported by photographers all over the world. Today's SLR is too large, too heavy and too noisy. Olympus took many years to develop the M-1 in order to successfully overcome these problems, without compromising in any way on performance. The M-1 should therefore, in a short time, become the standard of excellence in the 35mm SLR field.



A magnificently designed system built around a





remarkable compact precision camera



- With F1.8 lens : 660 gr. (23.3 oz.)
- With F1.4 lens : 720 gr. (25.4 oz.)
- With F1.2 lens : 800 gr. (28.2 oz.)
- Body only : 490 gr. (17.3 oz.)

OLYMPUS  
**M-1**



Motor drive with 250 frame continuous capacity

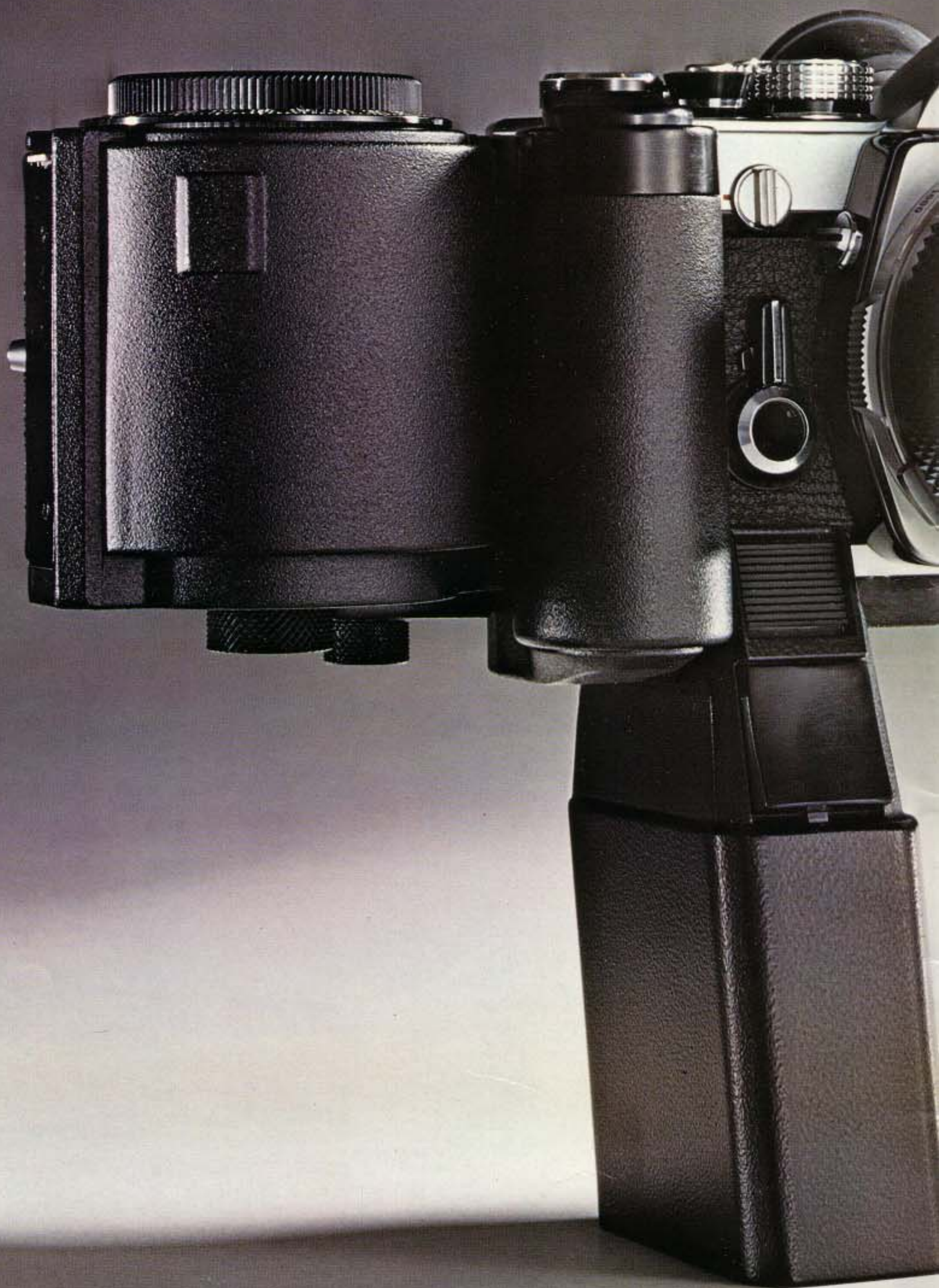





■ The smallest, lightest motor drive in the world









# Performance to meet new 35mm SLR standards

## ■ Top Performance, Easy Operation, Small Size

In this age of miniaturization, the Single Lens Reflex camera, with its bulky, heavy, awkward body is an anachronism. Despite this, each year more and more people buy SLR cameras. Obviously, they require the high performance and versatility offered by these cameras.

Therefore, the principal inspiration for the development of the M-1 was the creation of a complete system camera that would establish even higher standards in performance. But performance also relates to convenience. The new design of the M-1 provides a greater ease of operation resulting from smaller size and lighter weight. Until now, SLR cameras intended as components of a high performance system have not been able to achieve true compactness. Olympus achieved this goal by using radically new technology relying also on its extensive experience in the field of microscope and scientific instrument design.

However, the objective was to achieve miniaturization without sacrificing ease of operation or high performance. In fact, the stress on high performance in the M-1 sometimes dictated using larger parts inside the camera for greater reliability. The small 136mm x 83mm x 81mm ( $5\frac{3}{8}'' \times 3\frac{1}{4}'' \times 3\frac{1}{8}''$  with F1.8 lens attached) dimensions of the M-1 does not represent any compromise in performance, reliability or ease of operation.

## ■ Light Weight

Until the introduction of the M-1 it was thought that a 35mm SLR had to be heavy and bulky as a requirement of high performance. No longer. The M-1 with the F1.8 lens weighs only 660 gr. (23.3 oz.). It is the lightest 35mm SLR in the world, with an effective weight reduction of about 35% compared to average cameras of its type.

The volume of the M-1 (with F1.8 lens attached) is 400cm<sup>3</sup> (24.4 cubic inches), approximately 35% smaller than that of an average SLR. These

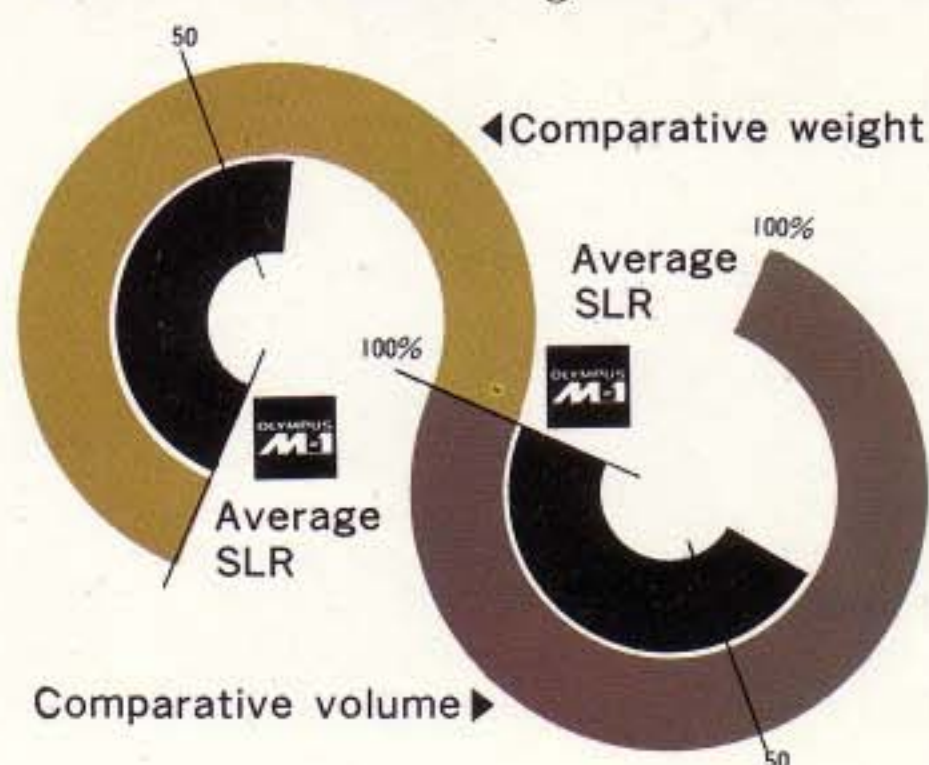

figures make it easy to understand to what extent the overall size of the M-1 has been reduced. Where a conventional 35mm SLR outfit would include one body and three lenses, two M-1 bodies and five lenses can be carried or stored in the same amount of space. This advantage alone makes possible a greater range of photographic activities. In addition the M-1 is only 83mm ( $3\frac{1}{4}$  inches) high, and although a larger pentaprism is used, the M-1 has a lower profile than any other 35mm SLR. Comparing this low profile to the large, ungainly pentaprism of the average 35mm SLR gives one a quick insight into the design philosophy behind the M-1.

## ■ Re-designing the 35mm SLR

The compactness of the M-1 was created by developing original mechanisms. Some traditional ideas about the design of SLR cameras were rejected. For example, the focal plane shutter that has been used continuously since the first Leica has been subjected to a radical re-examination. Even the ribbon which pulls the shutter curtain utilizes a newly developed special material that combines high strength with light weight. Another change is the integration of the film speed control with the metering system to eliminate unnecessary linkage. It would be impossible to significantly reduce the size of the camera merely by making minor reductions in the size of various individual parts. Only a radical new approach could produce a reduction of about 35% in comparative volume. But to achieve even a small reduction in size demands an enormous expense and effort in designing, testing, inspection and re-designing. Paradoxically, while the overall size of the camera was reduced, some parts were purposely made bigger. By using a small size sprocket and other devices often found in compact cameras, it would be quite easy to save a few millimeters. But this process of miniaturization was intentionally limited since a point exists beyond which a further decrease in size merely leads to difficulty in operation or a sacrifice in performance. The small size M-1 SLR camera does not include compromises in quality; savings in size and weight were accomplished by more ingenious engineering.







# Large, bright, wide angle viewfinder with interchangeable focusing screens

## ■ A New Concept in Viewfinders

The viewfinder is one of the most important features of a Single Lens Reflex system camera. Since every photographic subject is turned into a visual image by means of the finder; one that is dark or difficult to look through is an obstacle to good photography. The M-1 viewfinder is unusually bright, large and easy to use. One reason is that the viewfinder is larger from one edge to the other edge. The M-1 utilizes a new principle, a wider angle of view in the finder. (Apparent Field View  $20^{\circ}30'$  vertically and  $35^{\circ}$  horizontally.) This creates a larger image of the subject. If you compared the area visible when looking in the finder of the M-1 to that of a conventional 35mm SLR, you would notice that the M-1 area appears about 30% greater. This is the same phenomenon as found in television, where a 20 inch tube projects a larger image than a 16 inch tube, although the subject is the same. The field-of-vision of the finder is 97% of the actual picture area. The photographer photographs almost exactly what he sees. The M-1 finder compared to average SLR's shows an EV value of about 70% greater *brightness*. To keep light loss to an absolute minimum the M-1 has a silver coating on the pentaprism and a specially multi-coated mirror. A brighter, larger viewfinder is essential for all photography and especially critical when using extremely long telephoto lenses or for macrophotography, photomicrography, etc.

## ■ New Interchangeable Focusing Screens

An essential element contributing to the versatility of the SLR camera is a provision for interchangeable focusing screens. If a standard focusing screen is used with extra long telephoto lens, the microprism darkens and the screen becomes difficult to use. In macrophotography and photomicrography the high magnification makes it almost impossible to focus. On the other hand, in general photography a bright, clear screen is preferable. When a shift lens for perspective control is used it is necessary to have a scale to measure the extent of the shift of the lens axis. Unless the



most suitable focusing screen for a given photographic purpose is available, the potentialities of a system camera cannot be fully utilized. For that reason, until the present time the interchangeable pentaprism type SLR (with attendant problems of fit and dust) has been synonymous with the system camera. However, the major reason to remove the pentaprism is to change the focusing screen. The M-1, utilizing a new interchangeable focusing screen method, does not require a bulky, removable pentaprism. Although the body of the M-1 is of

compact size, it accepts 12 different kinds of interchangeable focusing screens thus providing the viewfinder versatility required by a full scale system camera. The screens can easily be changed in seconds.

## ■ Open Aperture Through-the-lens Metering

The M-1 exposure meter is a TTL type that measures the brightness of the light passing through the lens and striking the film surface. The finder always provides bright, open aperture metering. Two highly sensitive CdS cells positioned on opposite sides of the eyepiece function as the light receptors. They measure the brightness of the light entering, with extra weighting on the center of the picture. Changing lenses does not require any meter coupling adjustments. Proper exposure is obtained by adjusting the shutter speed and/or lens aperture until the exposure meter needle is centered in the viewfinder.



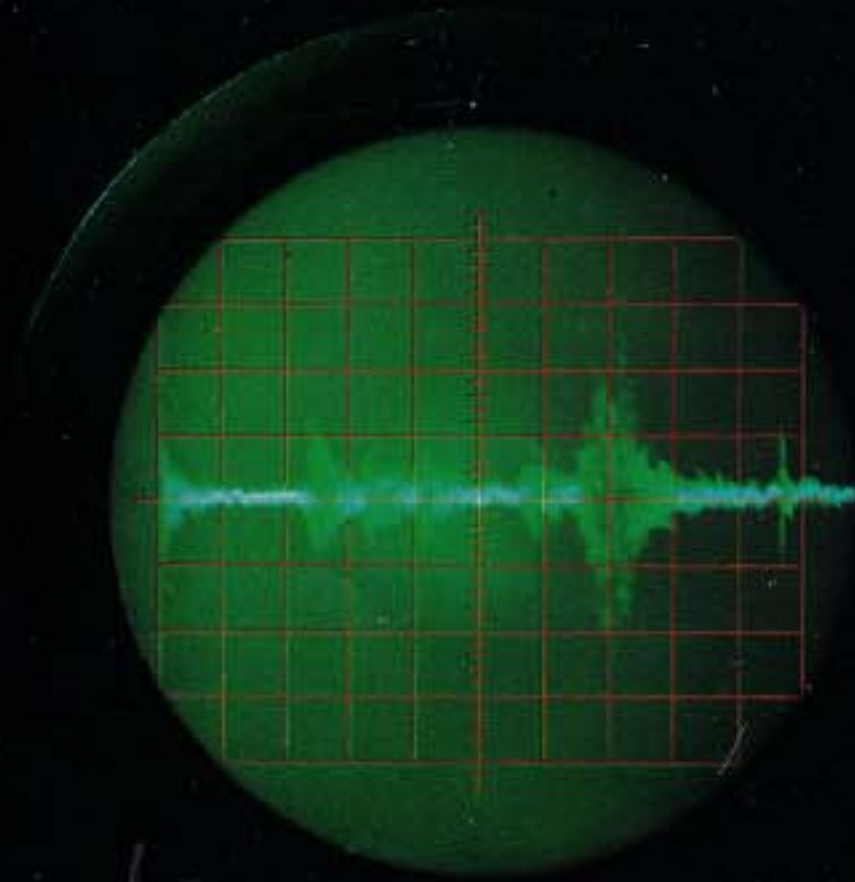
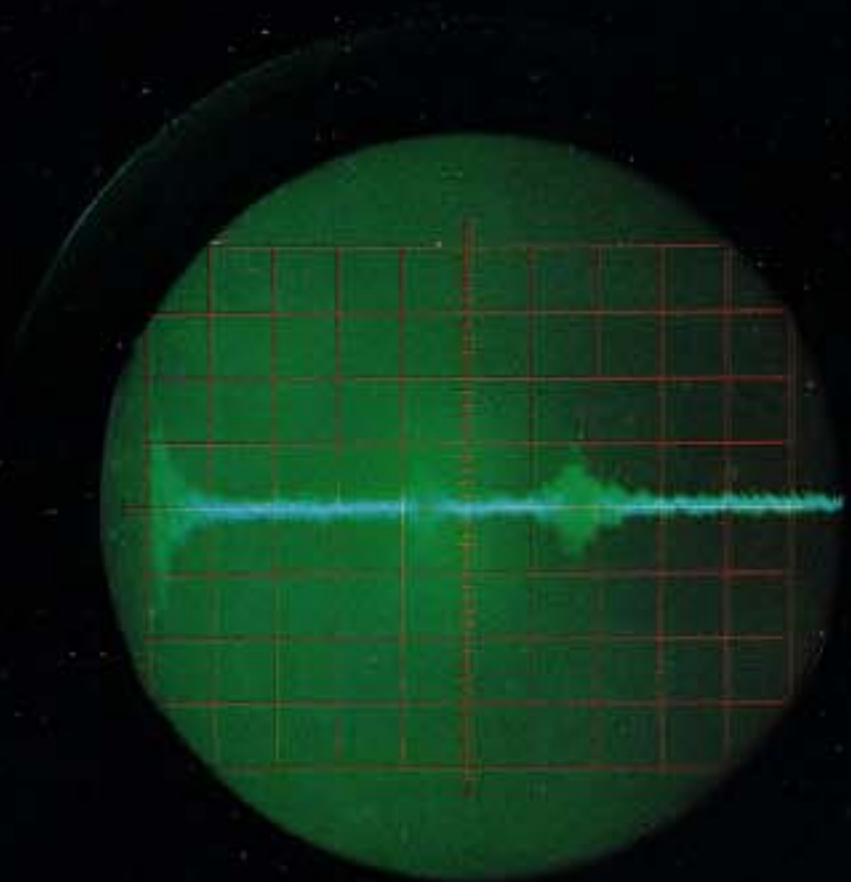
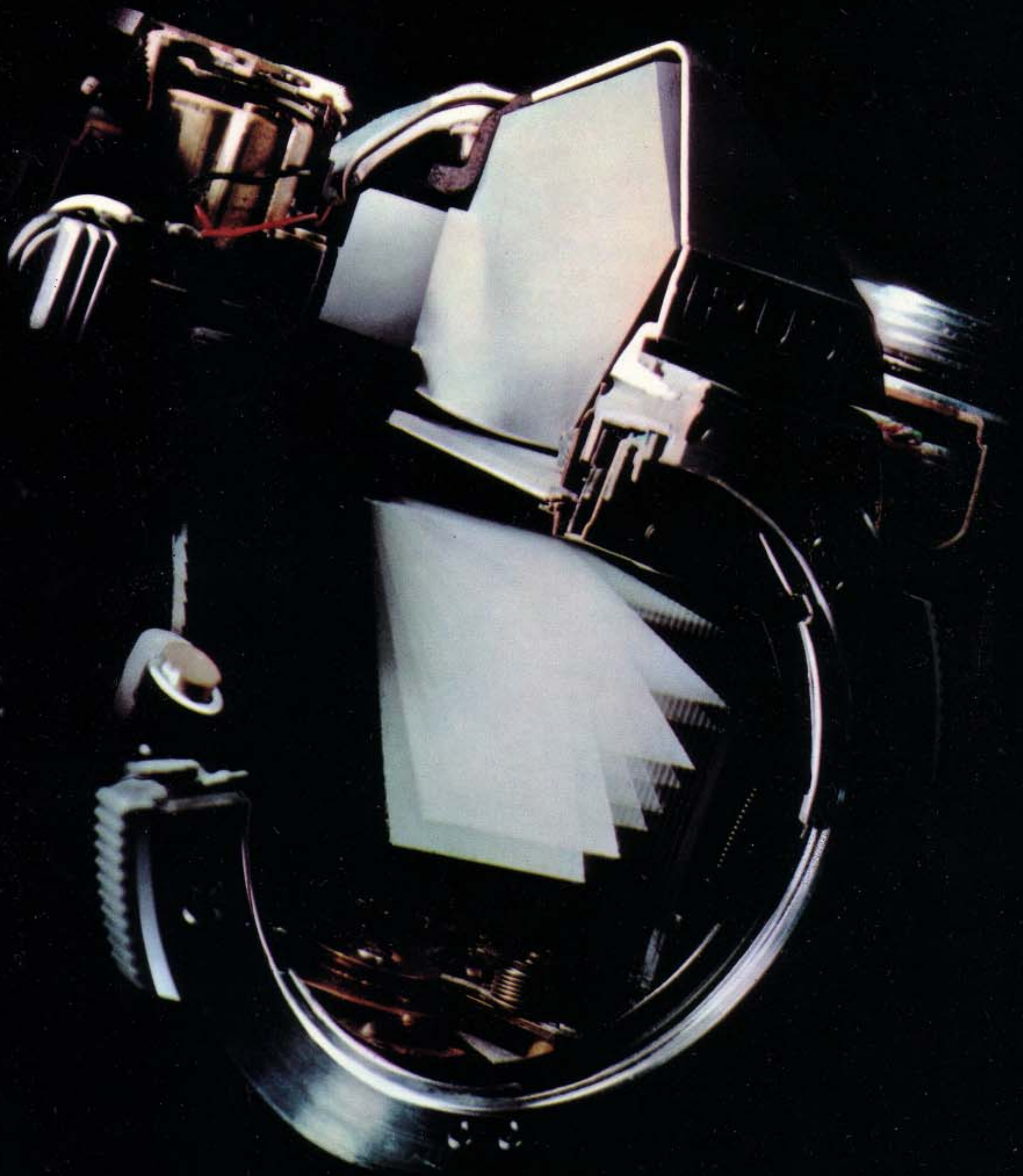



# Now an SLR camera that is seen but not heard

## ■ Quiet and Shock-free.

One of the differences that can be pointed out between Single Lens Reflex cameras with focal plane shutters and other camera with leaf shutters is the amount of noise and shock occurring at the moment the shutter is released. The present performance of SLR cameras is not satisfactory in these areas no matter how high the performance of the SLR might be in other respects. Since a noisy camera is an obtrusive camera and a large amount of shock gives rise to vibrations in the camera, these failings prevent an SLR camera from qualifying as an all-around no-compromise system camera. Olympus has succeeded in reducing noise and shock in the M-1 to such a level that it is directly comparable to the much quieter leaf shutter type rangefinder cameras. This is illustrated in the photographs on the lower left hand page showing camera noise and shock as displayed on an oscilloscope. The M-1 is represented on the left, and an average SLR camera on the right hand side. The difference is clear. Olympus is the first to succeed in accomplishing what had been considered impossible in previous SLR cameras.

The low noise and low shock permit the camera to be used without interfering with the solemnity of a wedding ceremony or a quiet moment in a stage play. However, the most important achievement is the reduction of camera vibration in hand-held photography at slower shutter speeds. The limits governing hand-held photography with telephoto lenses have been extended to cover previously impossible situations.

## ■ How it was Accomplished

A single lens reflex camera is made up of some 1,000 parts. When the shutter is activated, each part operates reciprocally. When one of the operating parts strikes another this naturally gives rise to noise and shock. Furthermore, if the speed is increased, this noise and shock becomes greater in proportion to the square of the speed. A new mechanism for the reduction of noise and shock was developed by Olympus. It includes (a) a shutter construction utilizing four ball-bearing trains, (b) a specially developed lightweight curtain drum which has the effect of cutting down noise, (c) full scale shock absorbers to damp the closing action, (d) mirror construction utilizing a special mecha-



nism and air dampers to reduce shock. This is the first time air dampers have been used in a 35mm SLR camera. In addition, shock absorbers have been fitted to all moving parts in the shutter and mirror structures as well as in the lenses. These shock absorbers are in more than twenty critical places throughout the camera.

## ■ Large Size Mirror

When using long telephoto lenses of more than about 300mm, the image in the viewfinder becomes obscured because the length of the

average mirror is inadequate, and the upper part of the finder darkens. In order to avoid this it is necessary to install a larger mirror. However, in the case of lenses with a large diameter and extreme wide angle lenses, the rear end projects too far into the camera body. If the mirror is lengthened it will strike part of the lens. Thus, on most conventional SLR cameras, it is impossible to increase the length of the mirror beyond a certain degree.

The unique design of the M-1 makes it possible to enlarge the mirror to 30.2 x 36.6mm. This large size mirror means that mirror cut-out will not occur in the viewfinder regardless of the lens used, from 8mm fisheye through 800mm ultra-long telephoto. Even with a mount that has a large diameter, no cut-off of the viewfinder will occur in photo copying, photo reproduction or photomicrography.

Another important requirement in a high quality SLR system camera, is the reduction to a minimum of reflection from the interior surfaces of the body and lens. In the M-1, the mirror box is larger, has serrated baffling and is coated with a special anti-reflection material. Therefore, the M-1 interior surfaces reflect an unusually low amount of light. The mirror can be locked up at any time as the need arises before or after the film has been advanced. It effectively eliminates all vibrations from mirror movement in situations such as high magnification microscope photography or high speed sequence photography using the motor drive.



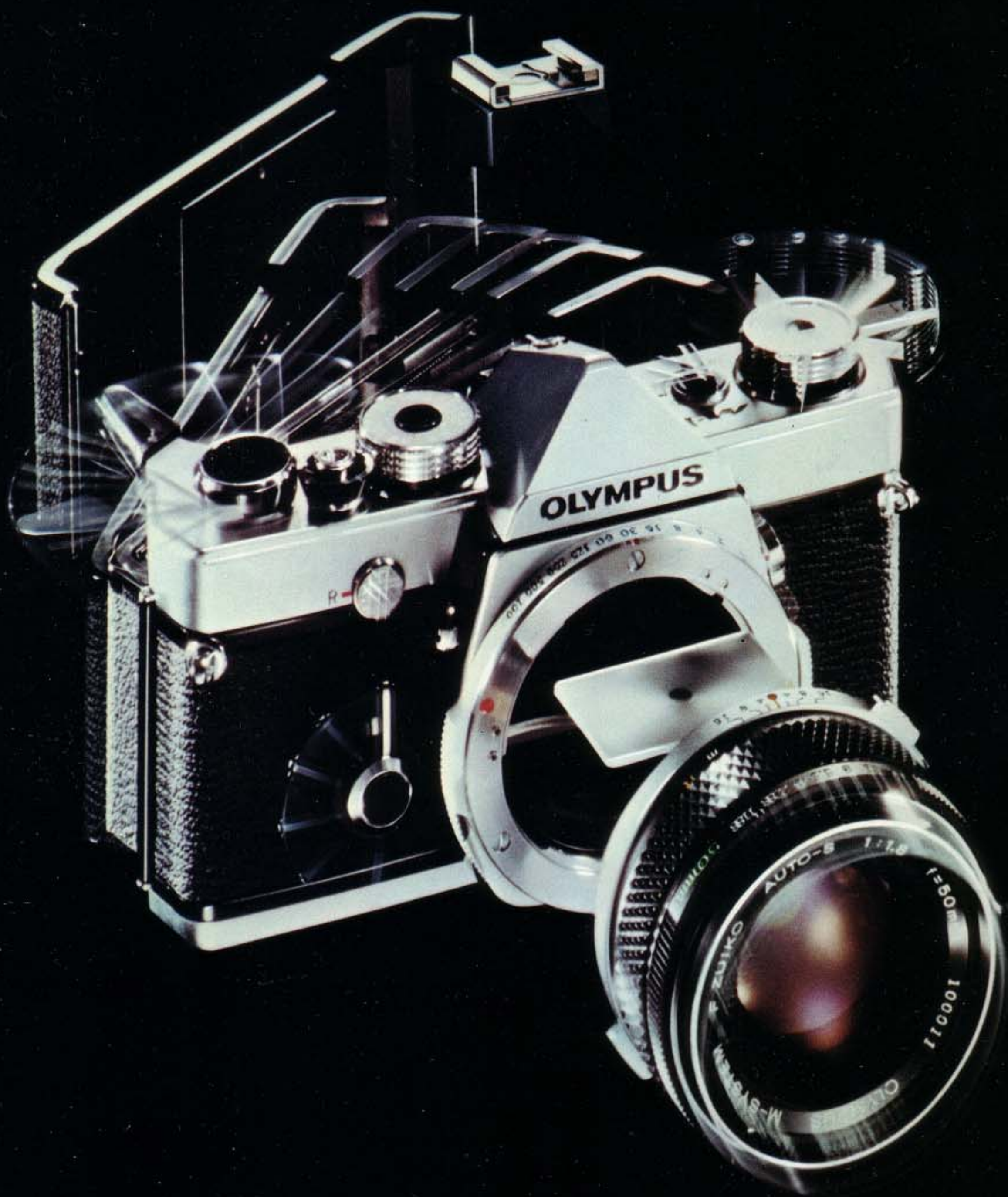



# Convenient and Rugged

## ■ The Human Factor.

The M system was designed to meet even the most demanding requirements of the professional photographer who will subject the camera to years of rugged use; even abuse. In view of this, miniaturization of the camera at the expense of durability was rejected. Even where a part had to be increased in size, it was done to guarantee the highest level of performance. And the M-1 body has been designed to fit snugly in the palm of the hand.

Some examples of attention to small details:

The shutter release button and its shutter ring are large allowing soft release shutter action. The smoothness of the releasing action is such that if the photographer is not listening carefully he may not notice the exact moment the shutter is tripped. The film speed dial is large and easy to read with a safety release. The exposure meter on-off switch is large, easy to use, and conveniently located. The shutter speed ring is located on the lens mount for greater convenience with large knurled tabs making it easy to set. The aperture, focusing and

shutter speed controls provide one hand operation right up to the moment the shutter is released. The film release lever is located on the front of the camera to make it easy to rewind the film even when the camera is attached to a tripod or copy stand. On most SLR's the camera has to be detached each time the film is changed.

A permanently attached accessory

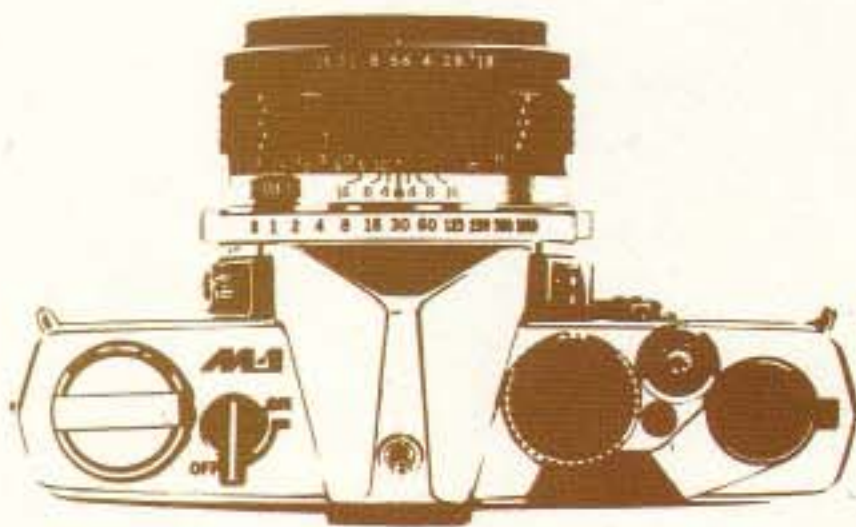

shoe is often inconvenient in a system camera because it interferes with some accessories. Therefore, the M-1 has a detachable type which can be fitted only when required. Lens changing is quick and easy with a one-touch motion consisting of pressing the release button and twisting the bayonet mount. Focusing screens and the rear cover can also be easily removed to permit complete interchangeability.

## ■ 100,000 Cycle Life Tests

However superb the performance and ease of operation of an SLR camera it is also necessary to have a robust mechanism which is reliable enough to function continuously and accurately, whatever the circumstances. In the moving parts of the M-1 shutter, special wear-resistant materials, ball bearings, and specially heat-treated metal parts are used. Olympus developed unique light weight curtain drums. For the body flange, difficult and expensive to machine but high value 18-8 nickel chromium steel was used. Every part was designed to perform consistently under the most rugged conditions experienced by professional photographers. The M-1 camera has such excellent durability that it withstood more than 100,000 cycle life tests, in extremes of temperature from 50°C (122°F) to -20°C (-4°F), without the slightest impairment of performance.

And the M-1 includes special "fail safe" devices that protect the camera from damage in case the photographer makes a mistake.



# The controls—all visible from above the camera



**1. Film Advance Lever**

Light, simple or multiple stroke film advance with a 150° winding angle. Advancing the film accomplishes the following: (1) The film is advanced by one frame; (2) the exposure counter moves forward one position; (3) the shutter is cocked; (4) the mirror is set in pre-operational position; (5) the automatic diaphragm mechanism is set; (6) a device is activated to prevent double film advancing; (7) the device for prevention of exposure during film advance is activated; and (8) the double exposure prevention mechanism is activated.

**2. Film Exposure Counter**

Automatic reset sequential type with the dial calibrated from S (Start) to E (End) as follows: S.. 1, 2-4-6 and all even numbered frames to 36-E.

**3. Shutter Release Button**

Located in the position naturally adopted by the index finger, the design provides for the outer ring to act as a support for the fleshy part of the finger, ensuring soft release action.

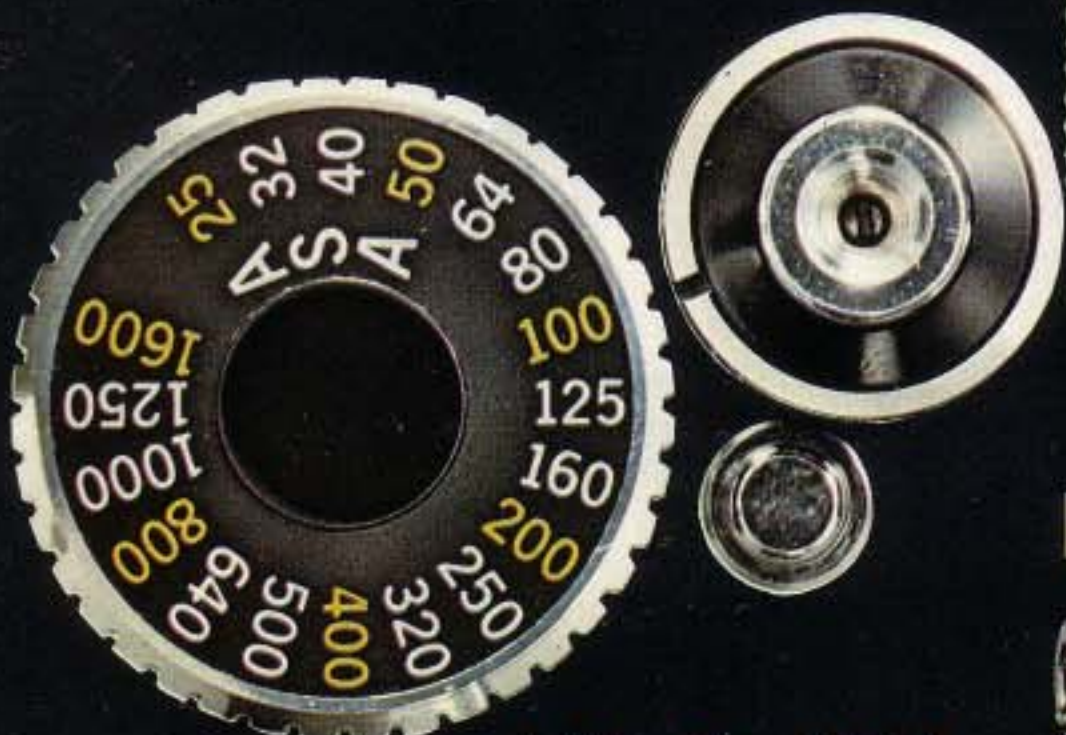

**4. Film Speed Dial**

**5. Film Speed Dial Release Button**

The ASA value of the film is set by turning the dial while pressing the release button. This button ensures that the ASA dial is not changed accidentally. Film speeds from ASA 25 to ASA 1,600 are marked on the dial.



**6. Exposure Meter Switch Lever**

ON/OFF Switching type. Switch to ON when taking a photograph. This will initiate the flow of current from battery and activate the exposure meter needle inside the viewfinder. When photographs are not being taken, return to the OFF position.



**7. Aperture Ring**

Intermediate values between numbers on the dial can be used allowing fine exposure adjustments. All of the Zuiko lenses feature automatic diaphragms. Therefore composition, focus, and other procedures are carried out with the diaphragm fully open for clear vision through the finder. The diaphragm closes to preselected aperture only at the moment the shutter is released.

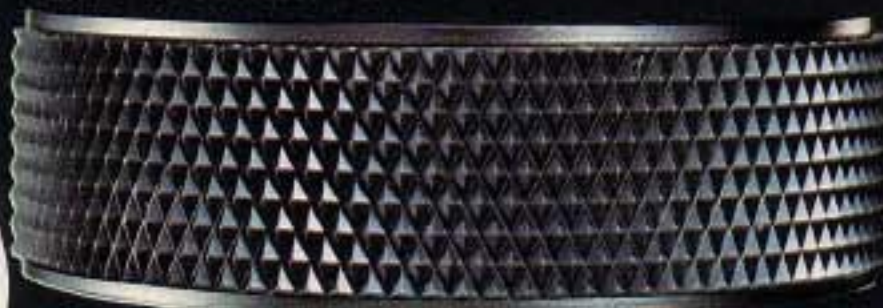

**8. Focusing Ring**

Focusing is fast and precise aided by the sleeve of textured, non-slip rubber fitted to the ring.



**9. Shutter Speed Ring**

Located on the lens mount. 12 shutter speeds are marked, from B to 1/1000 sec. Can be changed before or after advancing the film.



**10. View Finder Eyepiece**

Grooves on both sides of the eyepiece permit attachment of Varimagni finder, Eyecup 1, Dioptic Correction Lenses, and other accessories.

**11. Rewind Release Lever**

**12. Rewind Crank**

**13. Rewind Knob/Rear Cover Release**

The rear cover is



opened and closed by the rewind knob which is pulled up once to unlock then pulled out again to open.

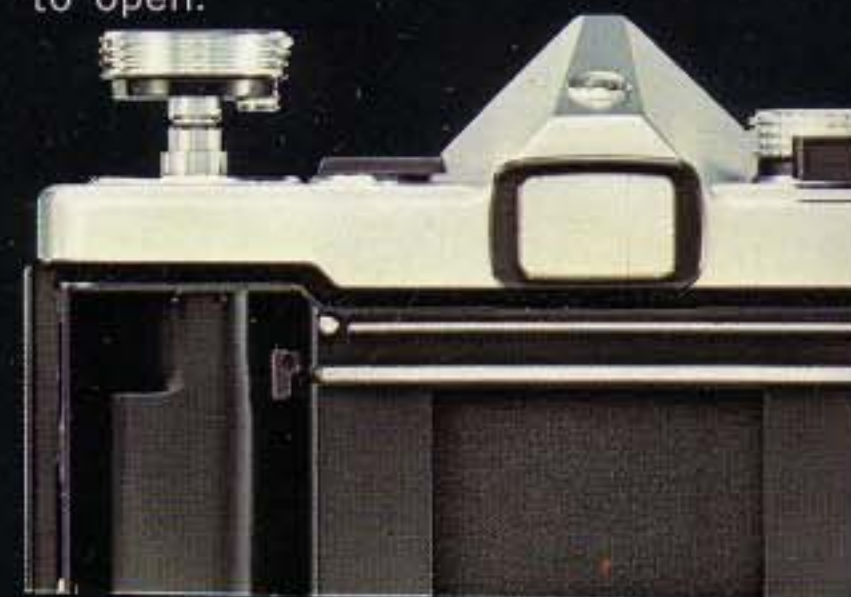

**14. Self Timer**

Set by rotating to the left 180°. The self timer is initiated by pushing the start lever concealed under the timer lever to the right. The shutter releases approximately 12 seconds later. It can be adjusted for any time between 4 and 12 seconds, stopped in the middle of operation, or reset.





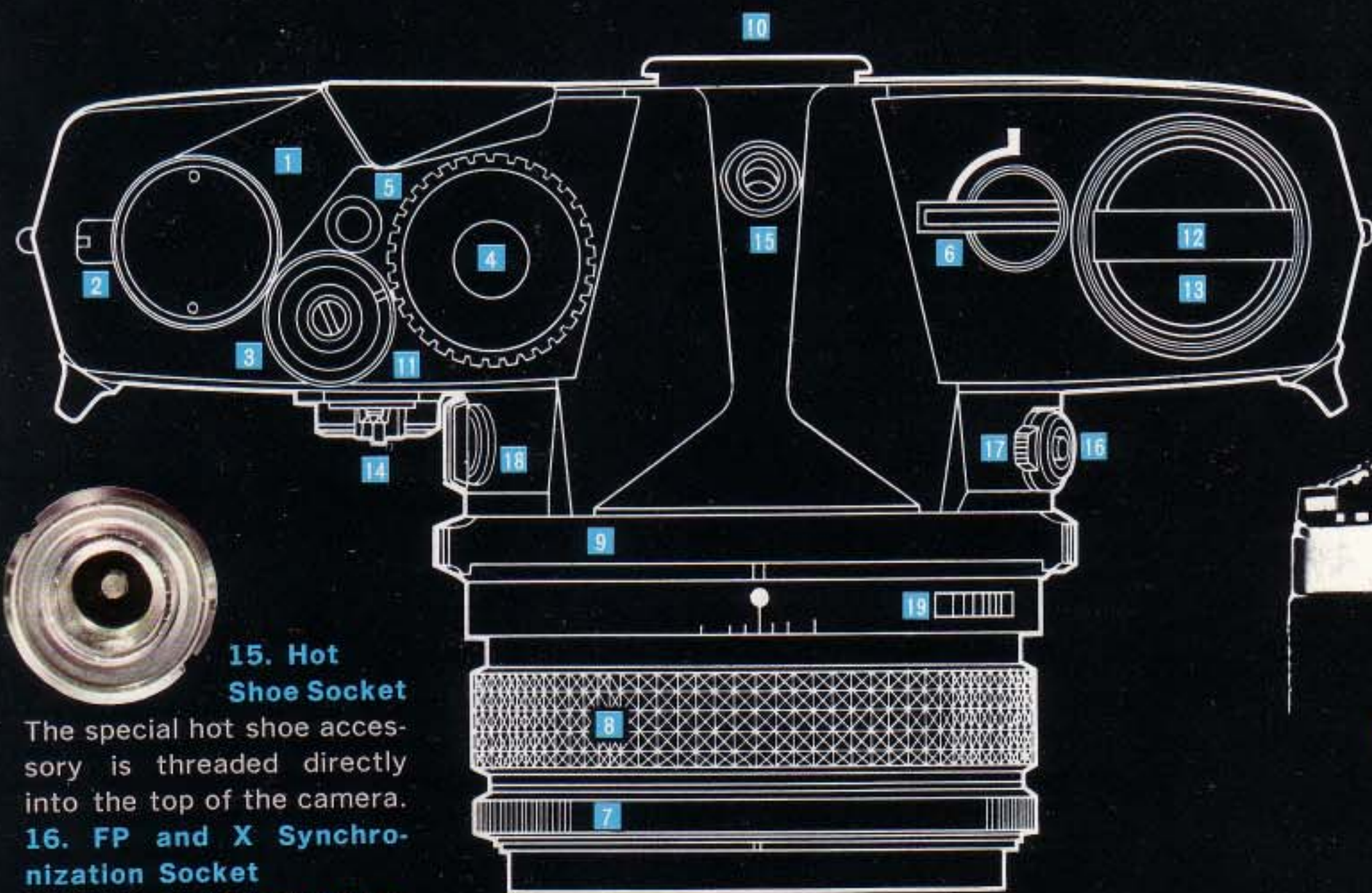

**15. Hot Shoe Socket**

The special hot shoe accessory is threaded directly into the top of the camera.

**16. FP and X Synchronization Socket**

**17. FP and X Flash Selector**

When FP type bulbs are used the red mark should be turned to "FP" and when electronic flash, M type or MF type bulbs are used, to "X". With FP type bulbs any shutter speed up to 1/1000 sec. can be set, and with electronic flash the shutter can be set from 1 to 1/60 sec. The shutter speed ring is color-coded for flash synchronization.

FP  
X

**18. Mirror Lock-Up Lever**

Turn 90° to the left to lock the mirror in the "UP" position. This setting can be done before, after or during film advance. The mirror lock-up

capability is useful for photo copying, photo reproduction and a wide range of photographic situations such as microscope photography, high speed sequence photography utilizing the motor drive and wherever vibration should be reduced to a minimum.

**19. Lens Release Button**

Bayonet type interchangeable lenses are quickly removed by pressing the release button and turning 70° to the left. The



body flange is large to provide satisfactory coverage when large diameter and long telephoto lenses, or various types of macrophoto or photomicro units are attached.

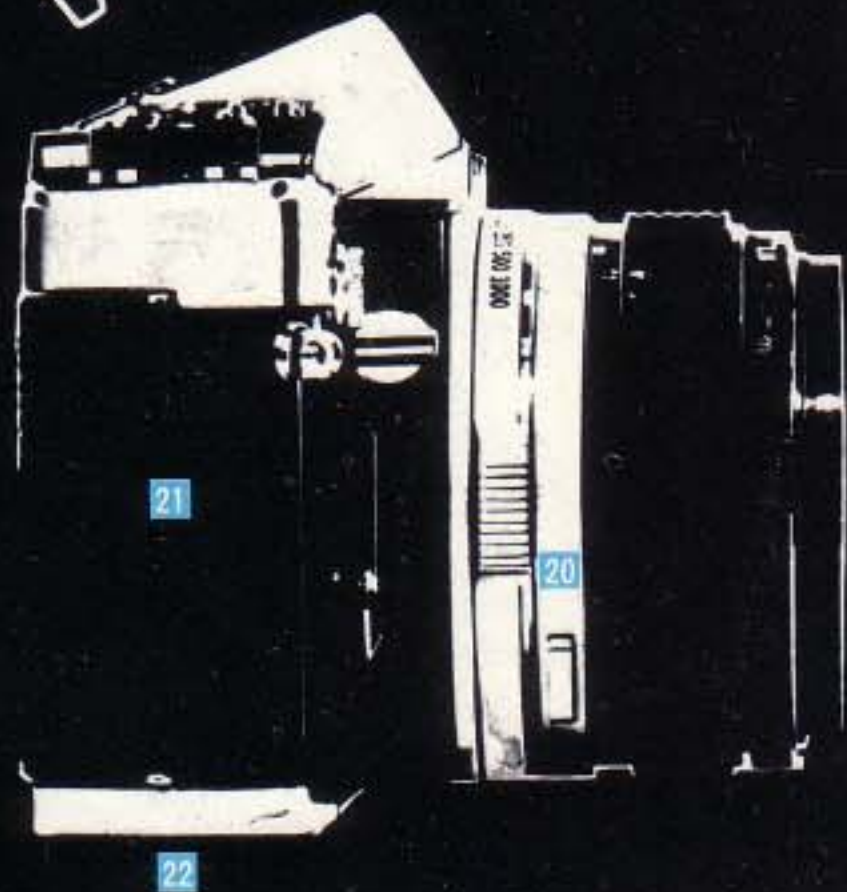

**20. Preview Button**

Located on the lower right side of the lens, pressing this button closes down the diaphragm to the pre-selected aperture for viewing depth of field.

**21. Rear Cover**

The interchangeable rear cover can be removed by pushing down the hinge pin. The Recordata Backs or the 250 Film Back can then be attached to the camera.



**22. Battery Chamber**

The chamber holds one 1.3 volt mercury battery. The life of a mercury battery is generally about one year.

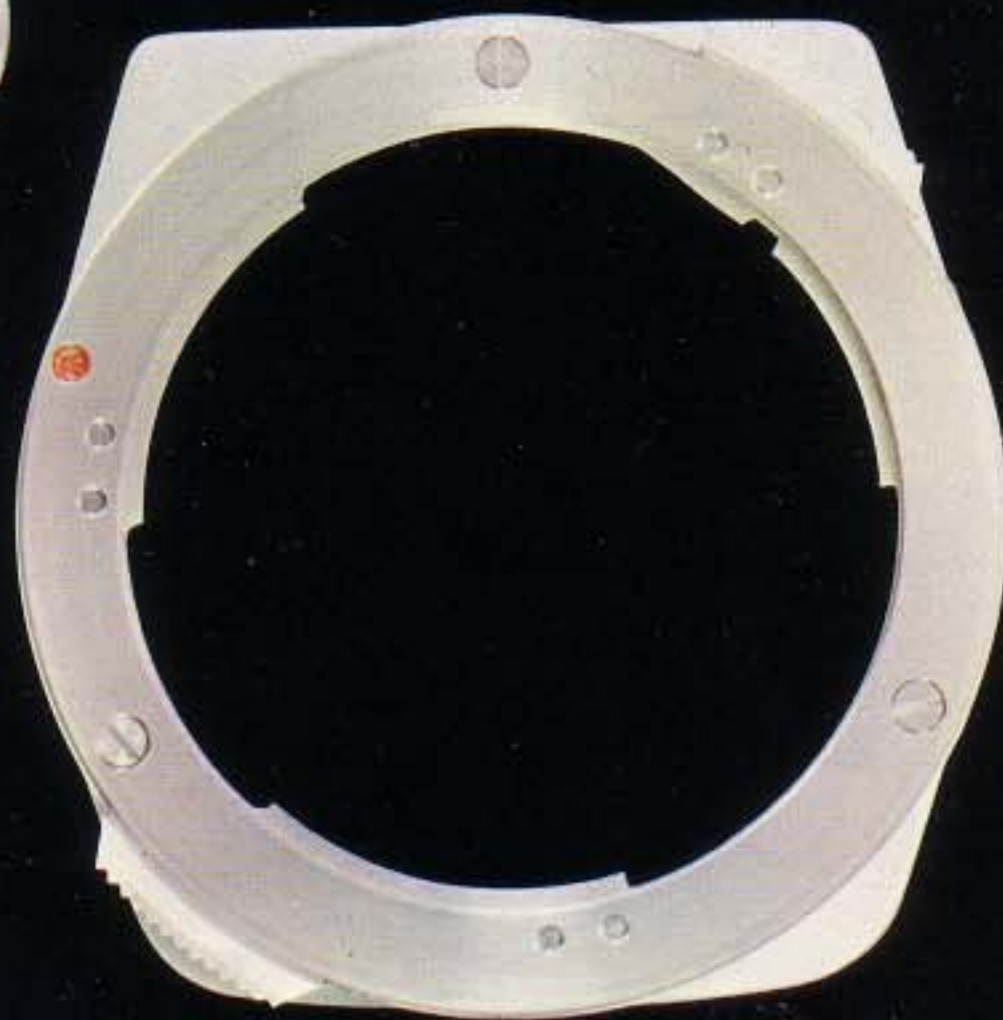
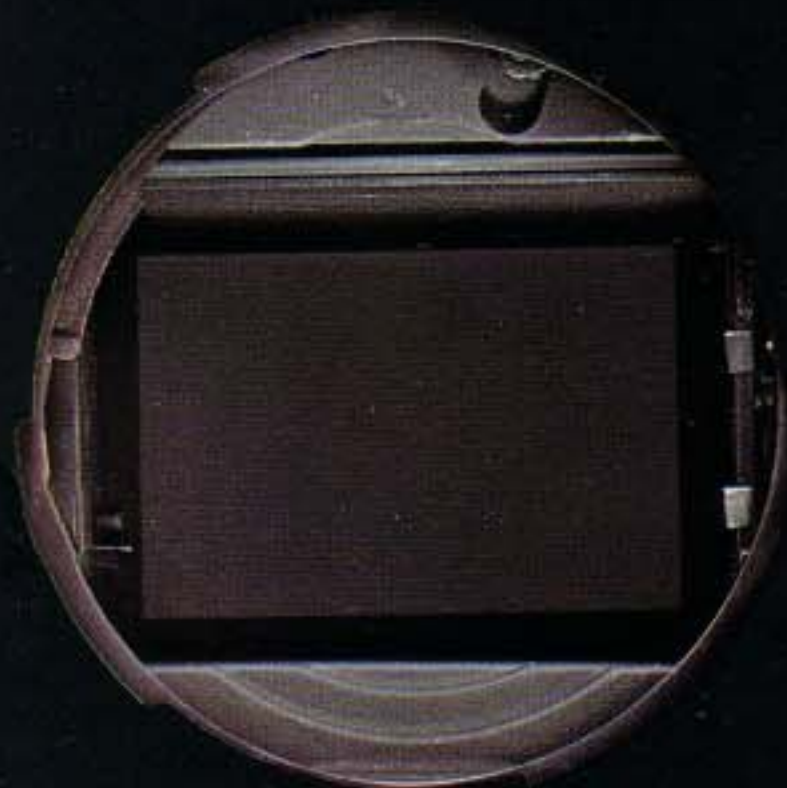



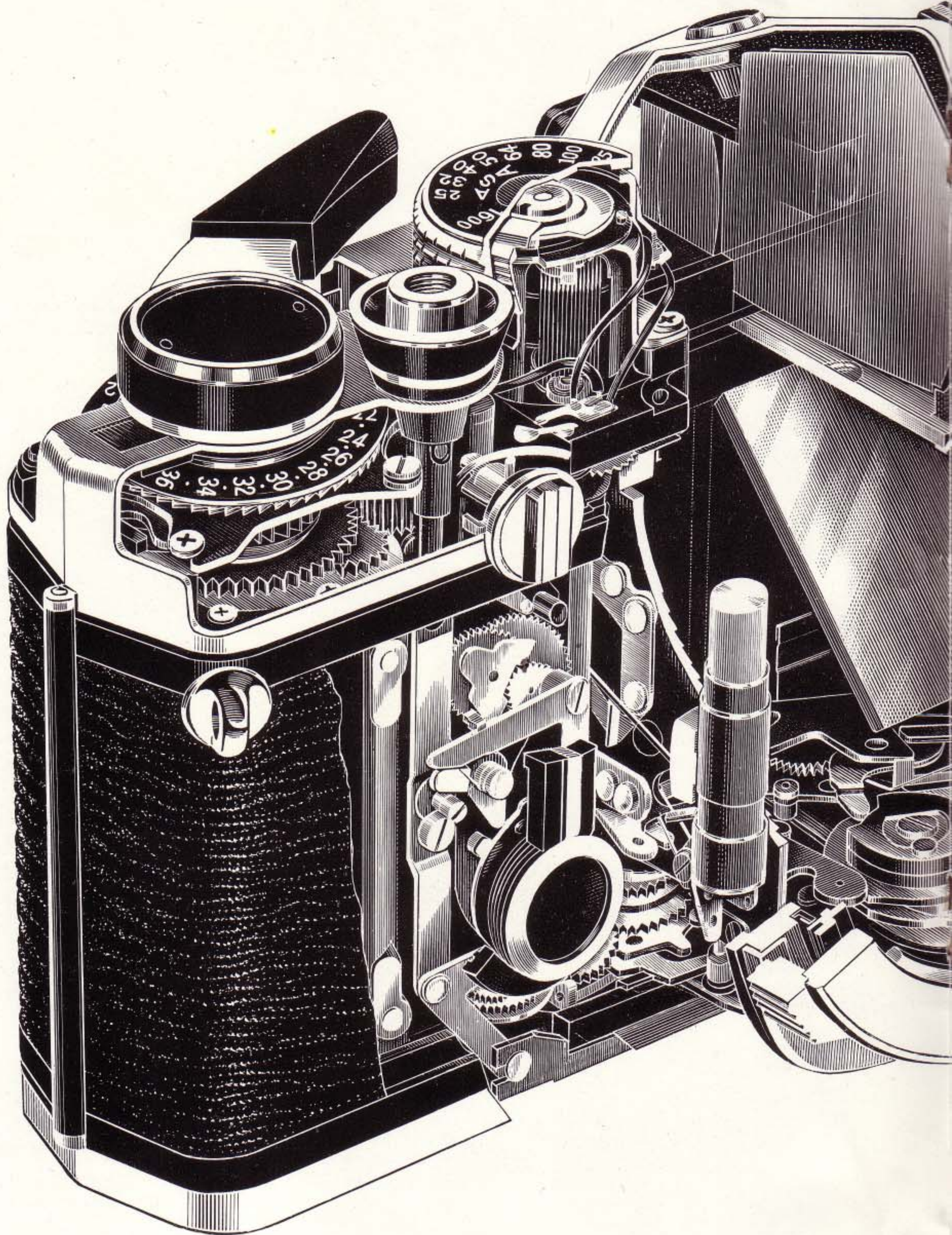



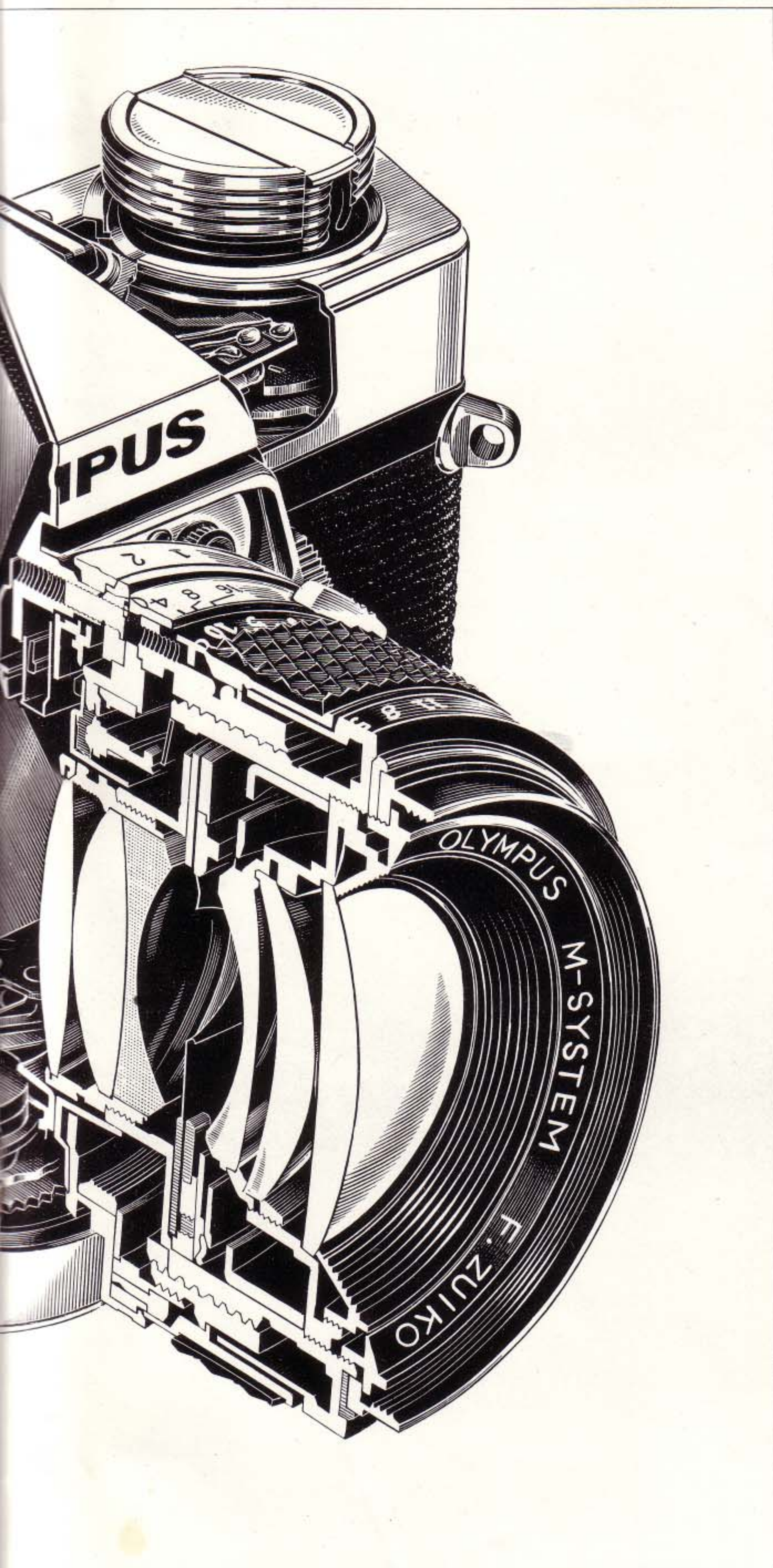

## Inside the M-1

The overall design of the M-1 combines new technology, innovative engineering features and high precision manufacturing.

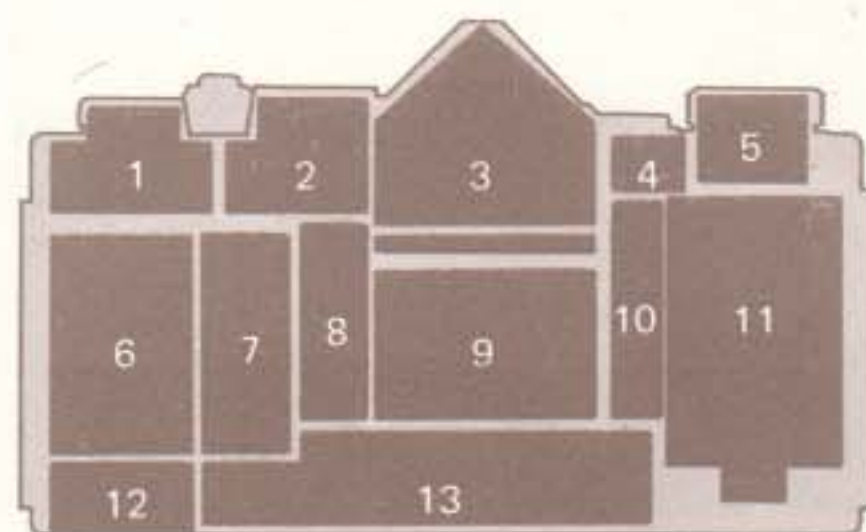

1. Film advance section
2. Meter section
3. Viewfinder section
4. Meter switch section
5. Film rewind knob section
6. Exposed film chamber
7. Self-timer section
8. Mirror, air damper section
9. Film plane
10. Mirror mechanism section
11. Film cartridge
12. Mercury battery
13. Shutter mechanism section

The M-1 was designed to higher standards and tolerances than previously set for 35mm SLR cameras. The degree of precision is so high that it was necessary to give special consideration to the different rates of expansion of various metal parts in varying temperature conditions. These were carefully worked out in exhaustive "life testing" of the camera. The long experience of Olympus in the manufacturing of laser measuring instruments, microspectrophotometers, medical instruments, and other scientific measuring instruments helped make possible the development of the world's most advanced and sophisticated 35mm SLR system.

The M-1 system was designed not only to provide the performance and convenience requirements of demanding photographers but also to meet the critical needs of technicians in every field of science.



The complete M system starts with more than 280 accessories

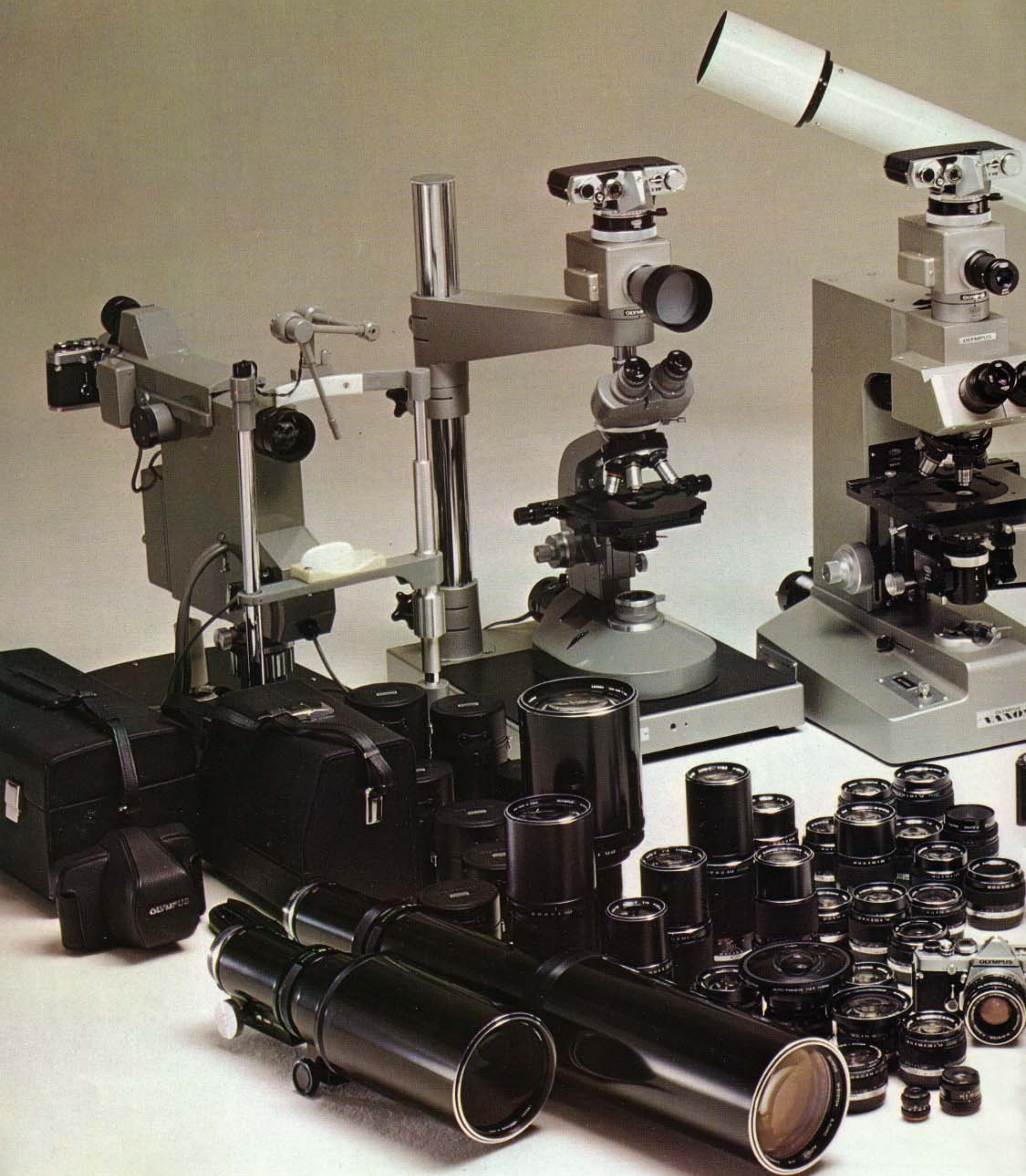



ssories and covers the whole field of Photography





# OLYMPUS

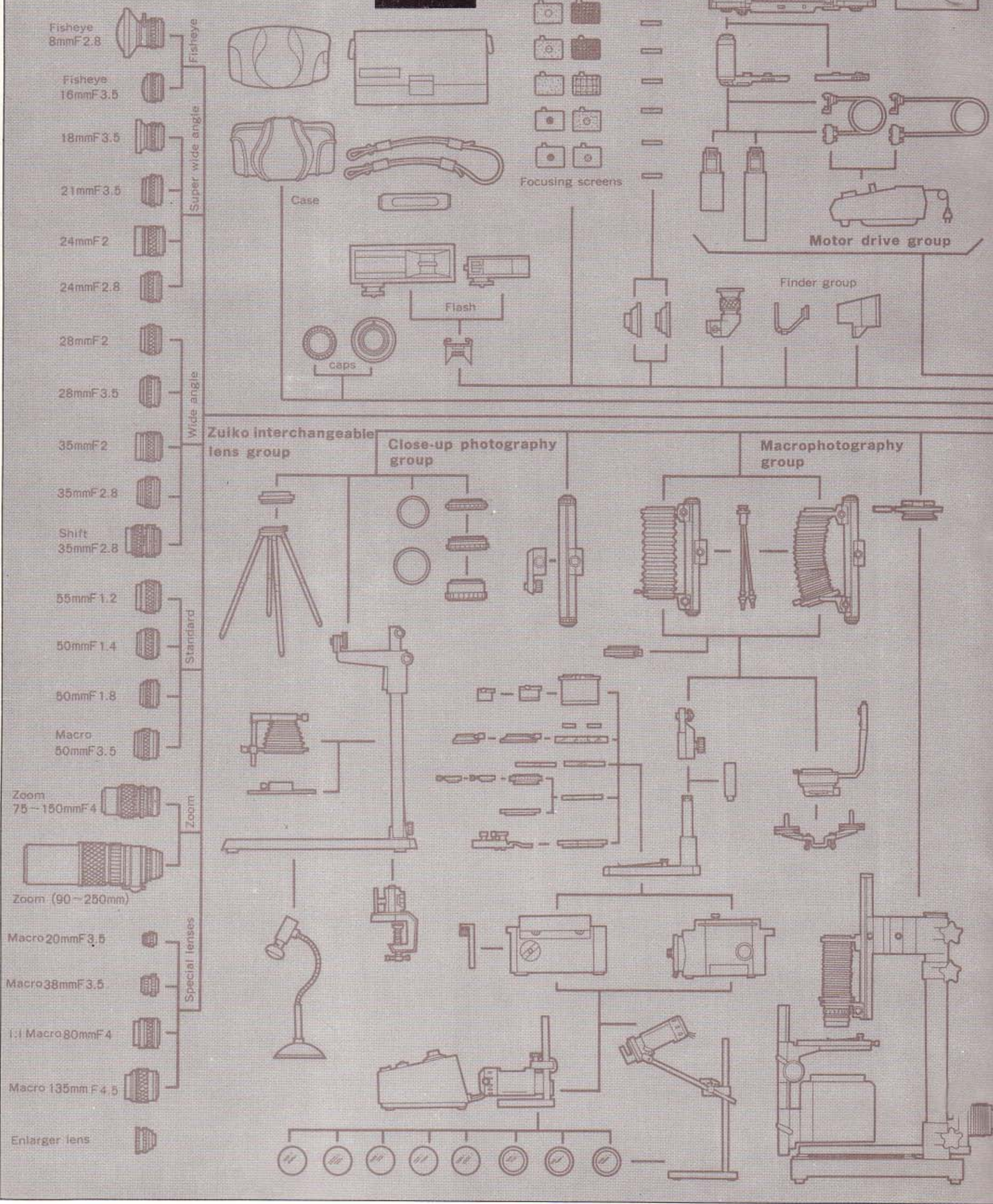



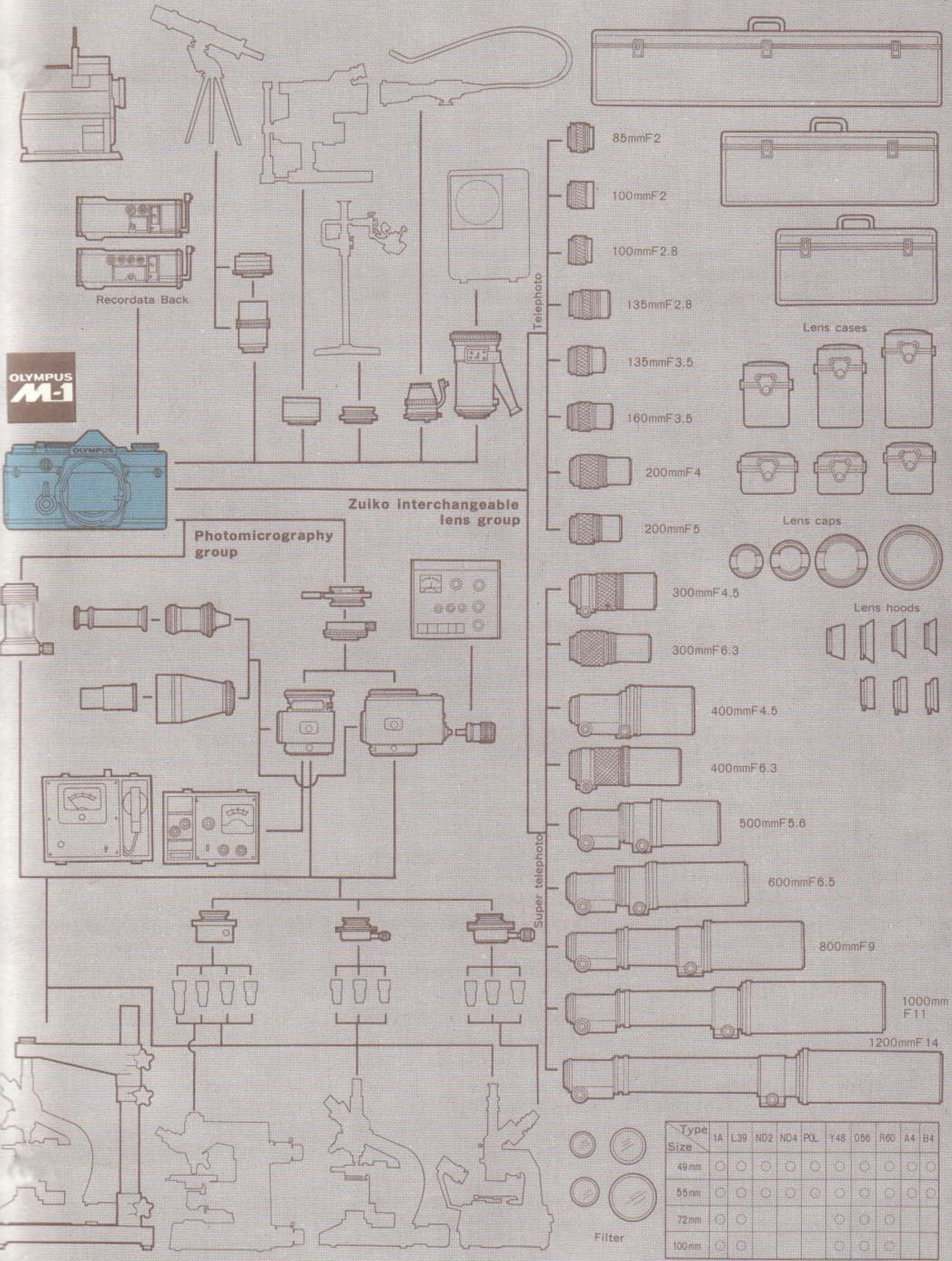

**OLYMPUS**  
**M1**

Recordata Back

Photomicrography group

Zuiko interchangeable lens group

Telephoto

Super telephoto

Lens cases

Lens caps

Lens hoods

- 85mmF2
- 100mmF2
- 100mmF2.8
- 135mmF2.8
- 135mmF3.5
- 160mmF3.5
- 200mmF4
- 200mmF5
- 300mmF4.5
- 300mmF6.3
- 400mmF4.5
- 400mmF6.3
- 500mmF5.6
- 600mmF6.5
- 800mmF9
- 1000mm F11
- 1200mmF14



Filter

Type	1A	L39	ND2	ND4	POL	Y48	056	R60	A4	B4
49mm	○	○	○	○	○	○	○	○	○	○
55mm	○	○	○	○	○	○	○	○	○	○
72mm	○	○				○	○	○		
100mm	○	○					○	○		









## Zuiko interchangeable lens group

The Zuiko interchangeable lens group (designed and manufactured by Olympus) comprises 38 lenses including those now in the course of development.

These lenses have a host of special features including a new construction that compensates for close distance aberrations, increased bore in the wide angle lenses, and reduction in telephoto lens size and

weight. The lens group uses 49mm filters for most lenses from 21mm to 200mm. As part of the M-System design all the lenses now offer higher performance in small configurations. Olympus has produced lenses for research microscopes for many years and the new Zuiko M-System lenses benefit from this scientific experience.

TYPE	INTERCHANGEABLE LENS	PICTURE	LENS COMPONENT ELEMENT GROUP	DIAPHRAGM	F-STOP RANGE	MIN. FOCUS (feet)	MIN. PHOTO GRAPHIC RANGE	WEIGHT (oz.)	LENGTH	MAX. DIAMETER	HOOD	FILTER
FISHEYE	ZUIKO AUTO-FISHEYE 8mm F2.8	180°	11-7	AUTO	2.8-22	0.2 m (0.7)		690g (24.3)	72mm	102mm	—	BUILT-IN
	ZUIKO AUTO-FISHEYE 16mm F3.5	180°	11-8	AUTO	3.5-22	0.2 m (0.7)		170g (6.0)	28mm	59mm	—	BUILT-IN
SUPER WIDE	L ZUIKO AUTO-W 18mm F3.5	100°	12-10	AUTO	3.5-16	0.2 m (0.7)	21 x 14cm	250g (8.8)	42mm	75mm	SCREW-IN	72mm
	G ZUIKO AUTO-W 21mm F3.5	92°	7-7	AUTO	3.5-16	0.2 m (0.7)	21 x 14cm	170g (6.0)	31mm	59mm	SCREW-IN	49mm
	J ZUIKO AUTO-W 24mm F2	83°	10-8	AUTO	2-16	0.25m (0.8)	23 x 15cm	280g (9.8)	40mm	50mm	SCREW-IN	55mm
	I ZUIKO AUTO-W 24mm F2.8	83°	9-7	AUTO	2.8-16	0.25m (0.8)	23 x 15cm	160g (5.6)	35mm	50mm	SCREW-IN	49mm
WIDE	I ZUIKO AUTO-W 28mm F2	75°	9-8	AUTO	2-16	0.3 m (1.0)	27 x 18cm	290g (10.2)	43mm	60mm	SCREW-IN	49mm
	G ZUIKO AUTO-W 28mm F3.5	79°	7-7	AUTO	3.5-16	0.3 m (1.0)	27 x 18cm	160g (5.6)	31mm	59mm	SCREW-IN	49mm
	H ZUIKO AUTO-W 35mm F2	63°	8-7	AUTO	2-16	0.3 m (1.0)	21 x 14cm	230g (8.1)	42mm	60mm	SCREW-IN	55mm
	G ZUIKO AUTO-W 35mm F2.8	63°	7-6	AUTO	2.8-16	0.3 m (1.0)	21 x 14cm	170g (6.0)	33mm	59mm	SLIDE-ON	49mm
STANDARD	S ZUIKO AUTO-S 55mm F1.2	53°	7-6	AUTO	1.2-16	0.45m (1.5)	25 x 19cm	310g (10.9)	45mm	58mm	SLIDE-ON	55mm
	R ZUIKO AUTO-S 50mm F1.4	47°	7-6	AUTO	1.4-16	0.45m (1.5)	26 x 16cm	230g (8.1)	36mm	50mm	SLIDE-ON	49mm
	F ZUIKO AUTO-S 50mm F1.8	47°	6-5	AUTO	1.8-16	0.45m (1.5)	24 x 16cm	170g (6.0)	31mm	50mm	SLIDE-ON	49mm
ZOOM	ZUIKO AUTO-ZOOM 75-150mm F4	32°-16°	15-11	AUTO	4-22	1.6 m (5.2)	36 x 24cm 74 x 49cm	400g (14.1)	115mm	63mm	BUILT-IN	49mm
TELEPHOTO	F ZUIKO AUTO-T 85mm F2	73°	6-4	AUTO	2-16	0.95m (3.1)	29 x 19cm	230g (8.1)	47mm	67mm	SCREW-IN	49mm
	E ZUIKO AUTO-T 100mm F2.8	64°	6-5	AUTO	2.8-22	1 m (3.3)	29 x 19cm	230g (8.1)	48mm	66mm	SCREW-IN	49mm
	L ZUIKO AUTO-T 135mm F2.8	18°	5-5	AUTO	2.8-22	1.3 m (4.3)	32 x 21cm	350g (12.3)	50mm	51mm	BUILT-IN	49mm
	C ZUIKO AUTO-T 135mm F3.5	18°	5-4	AUTO	3.5-22	1.5 m (4.9)	32 x 21cm	280g (9.9)	73mm	60mm	BUILT-IN	49mm
	E ZUIKO AUTO-T 200mm F4	12°	4-4	AUTO	4-32	2.5 m (8.2)	35 x 24cm	400g (14.1)	127mm	67mm	BUILT-IN	55mm
	F ZUIKO AUTO-T 200mm F5.6	12°	6-5	AUTO	5-32	2.5 m (8.2)	38 x 24cm	360g (12.7)	105mm	63mm	BUILT-IN	49mm
SUPER TELEPHOTO	F ZUIKO AUTO-T 300mm F4.5	8°	6-4	AUTO	4.5-32	3.5 m (11.5)	33 x 22cm	1000g (35.3)	181mm	80mm	BUILT-IN	72mm
	F ZUIKO AUTO-T 300mm F6.3	8°	6-5	AUTO	6.3-32	3.5 m (11.5)	33 x 22cm	600g (21.2)	171mm	70mm	BUILT-IN	55mm
	F ZUIKO AUTO-T 400mm F4.5	6°	6-4	AUTO	4.5-32	5 m (16.4)	35 x 23cm	2200g (77.6)	257mm	110mm	BUILT-IN	100mm
	F ZUIKO AUTO-T 600mm F6.5	4°	6-4	AUTO	6.5-32	11 m (36.1)	54 x 36cm	2800g (98.8)	377mm	110mm	BUILT-IN	100mm
	E ZUIKO AUTO-T 1000mm F11	2.5°	5-5	AUTO	11-45	30 m (98.4)	98 x 65cm	4800g (169.3)	562mm	110mm	BUILT-IN	100mm
SPECIAL USE	ZUIKO SHIFT 35mm F2.8	63°-34°	8-7	MANUAL	2.8-22	0.3 m (1.0)	21 x 14cm	350g (12.3)	17mm	70mm	SCREW-IN	49mm
	ZUIKO AUTO-MACRO 50mm F3.5	47°	6-4	AUTO	3.5-22	0.2 m (0.8)	72 x 48mm	200g (7.1)	40mm	60mm	—	49mm
	ZUIKO MACRO 20mm F3.5	50°	4-3	MANUAL	3.5-16	0.15m (0.5)	max. 8 x 8mm min. 2 x 4mm	50g (1.8)	20mm	25mm	—	21mm
	ZUIKO MACRO 38mm F3.5	50°	5-4	MANUAL	3.5-16	0.18m (0.6)	max. 20 x 13mm min. 6 x 4mm	70g (2.5)	28mm	37mm	—	35mm
	ZUIKO 1:1 MACRO 80mm F4	50°	6-4	MANUAL	4-22	0.25m (0.8)	max. 72 x 46mm min. 18 x 12mm	200g (7.1)	46mm	59mm	—	49mm

### ■ Fisheye, Super Wide Angle and Wide Angle Lenses

Each lens features the characteristic Zuiko high resolution and high contrast. The lens construction of the 18mm F3.5, the 24mm F2 and the 28mm F2 is specially designed for correcting aberrations at close distance giving these lenses superb potential for close-up photography. The 24mm F2 lens is the first 24mm super wide angle lens in the world to offer an aperture as fast as F2. Fisheye and super wide angle lenses are used to produce photographs giving exaggerated distortion effect; other wide angle lenses are useful in photographing in small areas where there is little space between camera and subject, where extensive depth of field is required, or when a panoramic effect is desired.

### ■ Telephoto and Super Telephoto Lenses

There are 11 telephoto lenses from 85mm to 1000mm allowing dramatic enlargements of distant subjects. The compact design 85mm and 100mm lenses, which are no bigger than many standard lenses, are best suited for portraiture. The 135mm and 200mm lenses are light enough to be hand-held and are suitable for sports photography and wherever a large image is desired. Because of the new compact and light weight design of the Zuiko super telephoto lenses from 300mm to 1000mm and the vibration free operation of the M-1 it has become possible to take hand-held pictures with lenses of up to 400mm. This widens the range of action of the photographer.

### ■ Zoom, Macro and Shift Lenses

The zoom lens, designed for high performance, small size and light weight, allows the photographer to compose freely in places where space is limited. There are four macro lenses, offering an unparalleled choice. The Macro 50mm F3.5 is the first of its kind in the world to feature correction for aberrations at close distance, an unusual accomplishment overcoming the limitation of image decay at high magnifications. The 1:1 Macro 80mm F4 is the first special purpose lens in the world for 35mm cameras allowing photography with equal size image reproduction (can be used with bellows). The Shift 35mm F2.8 is a wide angle lens that is capable of correcting perspective and is extremely useful in architectural photography.









## Motor drive group

When the photographer must take a sequence of action pictures at several frames per second to make sure he has captured the perfect moment, a motor drive is essential. The motor drive group, a planned part of the M System and not an after-thought, benefits from miniaturization. It is light and very easy to operate. The combination of

Motor Drive 1 and M. 12V Battery when attached to the M-1 is the smallest motor drive package in the world. Compact enough to permit hand-held photography even with a 300mm telephoto lens, its versatility is further expanded when the motor drive is used in combination with units from other groups.

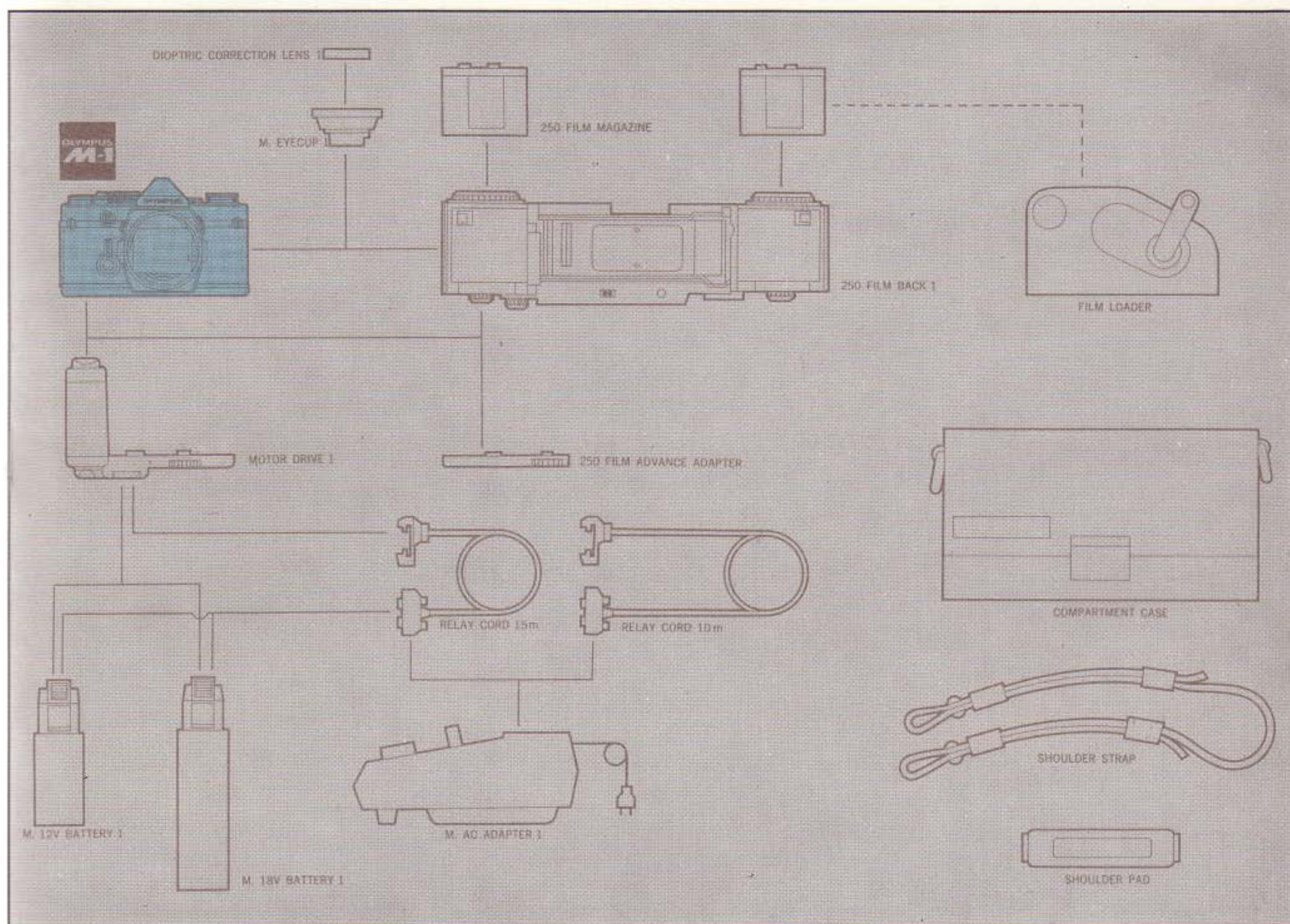

### ■ Motor Drive 1

The main motor drive body is directly connected to the M-1 using the tripod socket. Operating off various power sources including 12V DC, it has variable speeds from one frame every 3 seconds to a maximum of 4 frames per second.

### ■ 250 Film Back 1

This interchangeable back for use with 250 frame length bulk film is attached after removing the M-1 rear cover. It is used in combination with the Motor Drive 1 or the 250 Film Advance Adapter.

### ■ 250 Film Magazine

Magazine for use with bulk film.

### ■ 250 Film Advance Adapter

Used to advance the film when the 250 Film Back is attached and the Motor Drive 1 is not used.

### ■ M. 12V Battery 1 (pistol grip)

### ■ M. 18V Battery 1 (pistol grip)

There are battery cases taking either 8 or 12 1.5V No. 3 batteries. They are easily attached to the Motor Drive 1. The release button, single frame release, sequential frame release and timer are built-in.

### ■ M. AC Adapter 1

An adapter for using standard household AC current. Single frame/sequential frame switch, relay cord terminal and timer for sequence shooting are built-in.

### ■ 1.5m, 10m Relay Cords

There are extension cords available in two lengths.

### ■ Film Loader

Winding equipment for loading film into the 250 Film Magazine.

### ■ M. Eyecup 1

For use with the 250 Film back.

\* Specifications are subject to change without notice.

\* The motor drive can be quickly and easily installed at any Olympus factory service center.





## Close-up range

PHOTOMICROGRAPHY RANGE (mm)	240	120	48	24	12	4.8	2.4	1.2						
MAGNIFICATION	$\times 360$	$\times 180$	$\times 72$	$\times 36$	$\times 18$	$\times 7.2$	$\times 3.6$	$\times 1.8$	50	100	200	500	1000	TIMES
ASTROSCOPE ADAPTER	[Diagram showing astrocope adapter]													
STANDARD LENS	[Diagram showing standard lens]													
STANDARD LENS + CLOSE-UP LENS	[Diagram showing standard lens + close-up lens]													
MACRO 50mm F3.5 + CLOSE-UP LENS	[Diagram showing macro lens + close-up lens]													
EXTENSION TUBE 7	[Diagram showing extension tube 7]													
EXTENSION TUBE 14	[Diagram showing extension tube 14]													
EXTENSION TUBES 7 + 14	[Diagram showing extension tubes 7 + 14]													
EXTENSION TUBE 25	[Diagram showing extension tube 25]													
EXTENSION TUBES 7 + 25	[Diagram showing extension tubes 7 + 25]													
EXTENSION TUBES 14 + 25	[Diagram showing extension tubes 14 + 25]													
EXTENSION TUBES 7 + 14 + 25	[Diagram showing extension tubes 7 + 14 + 25]													
MACRO 50mm F3.5	[Diagram showing macro lens]													
EXTENSION TUBE 25 + MACRO 50mm F3.5	[Diagram showing macro lens + extension tube]													
EXTENSION TUBE 25 + MACRO 50mm F3.5	[Diagram showing macro lens + extension tube]													
1:1 MACRO 80mm F4	[Diagram showing macro lens]													
MACRO 50mm F3.5 OR STANDARD LENS	[Diagram showing macro lens]													
MACRO 38mm F3.5	[Diagram showing macro lens]													
MACRO 20mm F3.5	[Diagram showing macro lens]													
1:1 MACRO 80mm F4	[Diagram showing macro lens]													
MACRO 50mm F3.5 OR STANDARD LENS	[Diagram showing macro lens]													
MACRO 38mm F3.5	[Diagram showing macro lens]													
MACRO 20mm F3.5	[Diagram showing macro lens]													
CLOSE-UP PHOTOGRAPHY GROUP	[Diagram showing PEN UP-3 and COPY STAND]													
MACROPHOTOGRAPHY GROUP	[Diagram showing STANDARD LENS, FOCUSING RAIL, and MACRO PHOTO STAND]													
PHOTOMICROGRAPHY GROUP	[Diagram showing AUTO BELLOWS, MACRO PHOTO STAND, and M MOUNT PHOTOMICRO ADAPTER]													



## Close-up photography group



The M-1 focuses as close as 45cm (17<sup>3</sup>/<sub>4</sub>"') with the *standard* lens. In addition there is a very extensive choice of close-up accessory units. The M-System close-up photography group includes close up lenses, ex-

tension tubes, the 50mm macro lens, etc., offering extreme flexibility and scientifically precise results. A copy stand is also available for specialized photo reproduction work.

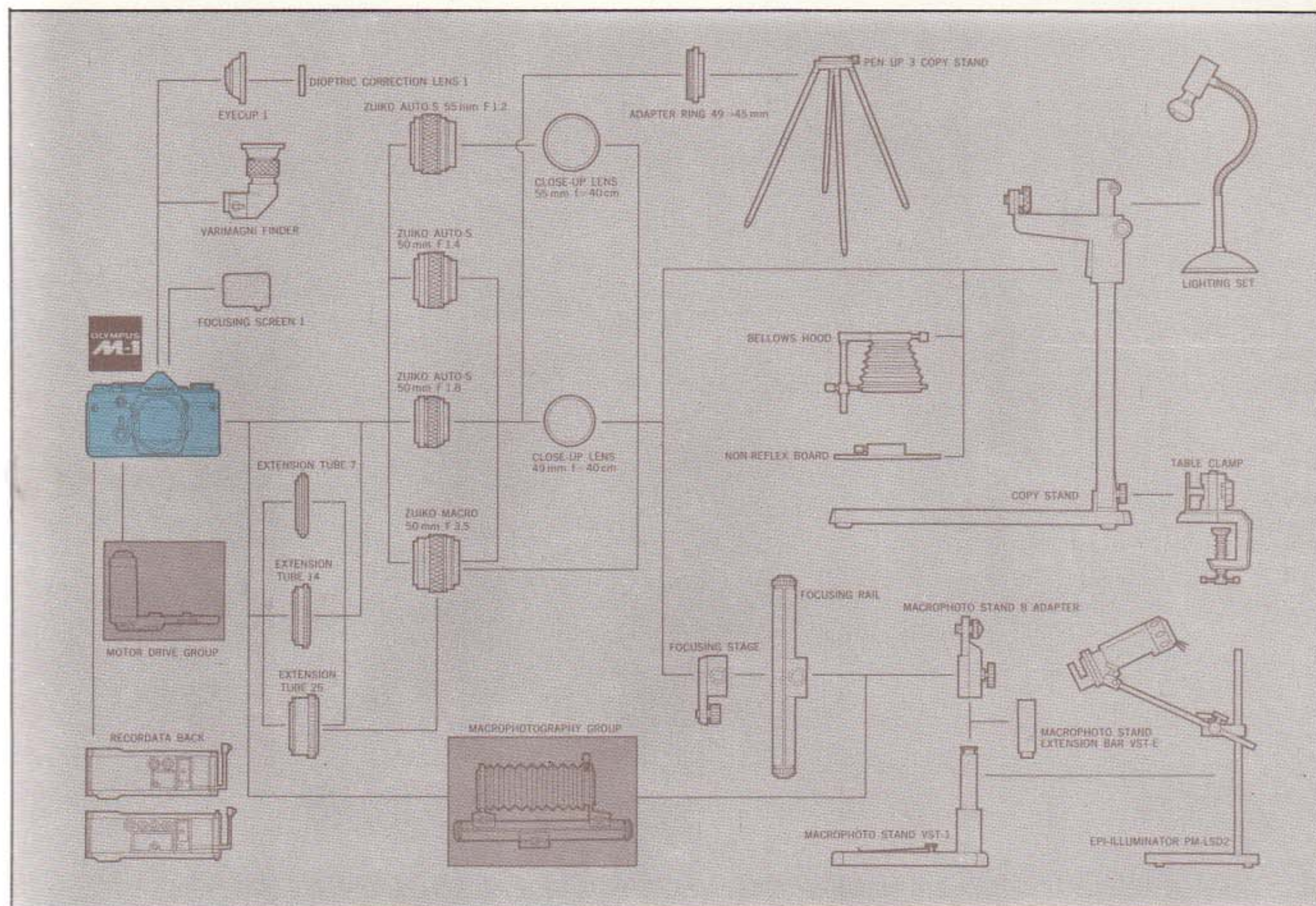

■ **Close-Up Lens 49mm f=40cm**

■ **Close-Up Lens 55mm f=40cm**

These auxiliary lenses reduce the minimum focusing distance of a standard lens from 19 cm (7<sup>1</sup>/<sub>2</sub>"') (from the front element) and provide greater image magnification.

■ **Extension Tube 7**

■ **Extension Tube 14**

■ **Extension Tube 25**

These tubes fit between the M-1 body and the lens. The bayonet mount tubes have a thickness of 7mm, 14mm and 25mm, respectively, and can be assembled in a total of 7 different combinations. For example, when the 25mm tube is used together with macro 50mm F3.5, it offers an extended close-up photograph range from 1/2 to 1:1 magnifications.

■ **Adapter Ring 49-45mm**

The adapter used to connect the 50mm lens with the Pen Up 3.

■ **Pen Up 3**

A four-legged close-up photography stand for rigid close-up and copy photography. Length of the legs is adjustable in three stages, according to the size of the subject.

■ **Copy Stand**

A standard type stand for general close-up and copy photography. Two special lights can be connected to the front edge of the rugged, H-shape construction stanchion. Anti-vibration equipment and locking apparatus are attached.

■ **Lighting Set (2 pieces, 1 set)**

Consisting of a stable base and a light arm.

■ **Table Clamp**

■ **Varimaghi Finder**

This unique and exclusive accessory for the M System combines the two functions of angle finder and magnifier. The two-stage, one-touch switching system offers both a 1.2 magnification image covering the whole finder viewfield, or a 2.5 times enlargement of the central portion only for critical focusing. It is ideal for composition and focusing both in close-up and general photography.

■ **Eyecup 1** (with attached rubber hood to prevent light entering from the back) Essential for close-up photography and stop-down aperture light metering. Can be used in conjunction with a push-on visibility dioptric correction lens.

■ **Dioptric Correction Lens 1**

+2, +1, 0 (for hypermetropia), -1, -2, -3, -4, -5 (for myopia)



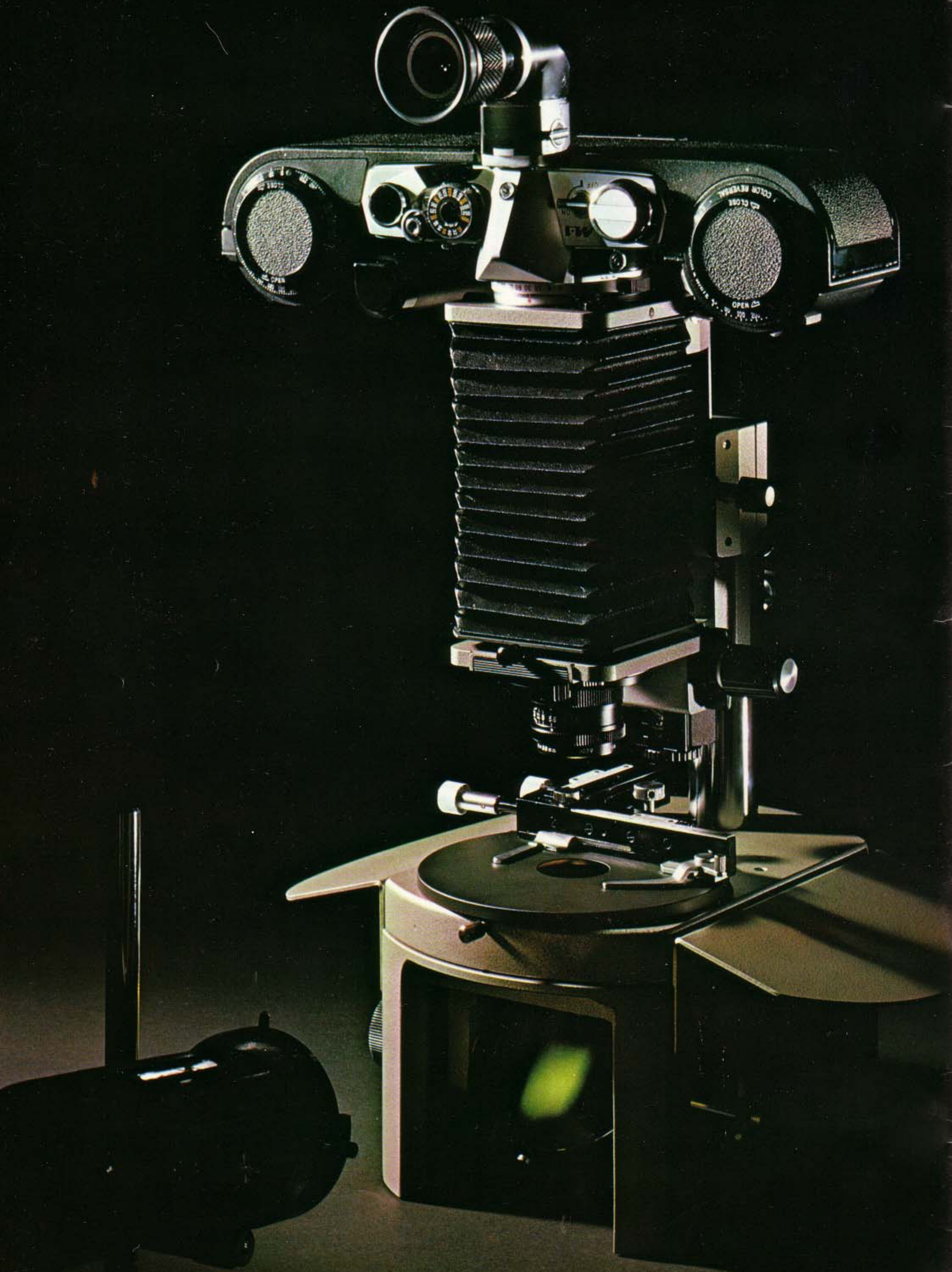





## Macro photography group

Extreme close-up and macro photography overcomes the limitations of human vision. Tiny objects imperceptible to the human eye can be captured on film, revealing a miraculous new world of exciting shapes and colors. The macro photography group of the M-System offers a complete range of convenient, high perform-

ance accessories designed for specialists in the various fields of macro photography. Starting with 5 macro lenses, auto bellows and macrophoto stands and extending to a large variety of holders and frames, lighting equipments, etc., it is the world's most comprehensive and versatile system.

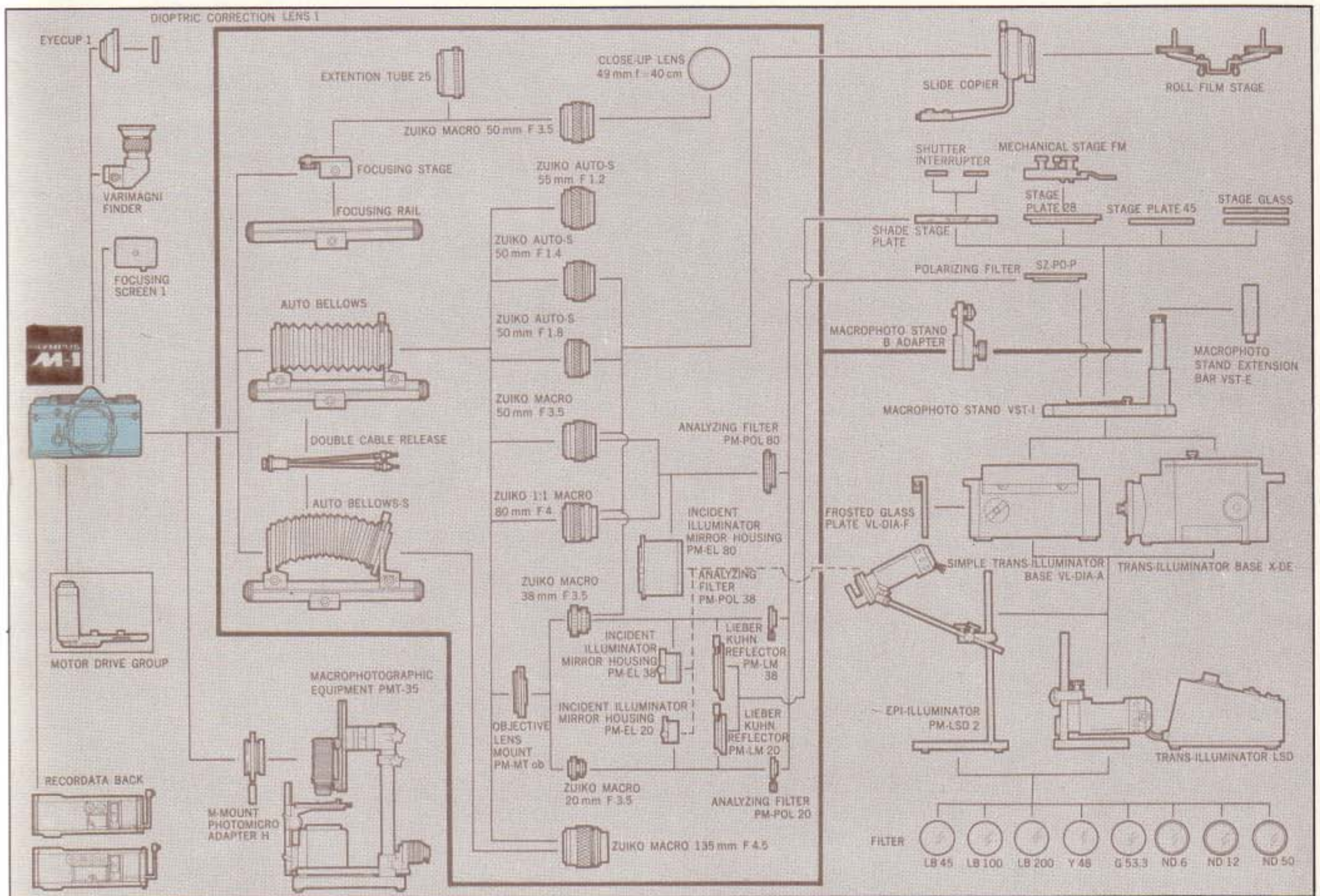

### ■ Auto Bellows

A versatile, precisely constructed bellows system including the bellows section, the focusing rail, and the focusing tripod mount. Separate adjustments can be made of magnification and focusing.

### ■ Double Cable Release

### ■ Slide Copier

This apparatus is used in combination with the bellows to produce duplicate photographs.

### ■ Roll Film Stage

Used when producing duplicates from uncut long roll film.

### ■ Focusing Rail

### ■ Focusing Stage

A base mount attached to the rail, on which the camera is attached.

### ■ Macrophoto Stand VST-1

A rugged, compact, precision-made stand designed especially for close-up and magnified photographs. It is used together with one of a variety of stage plates.

### ■ Macrophoto Stand Extension Bar VST-E

### ■ Macrophoto Stand B Adapter

A special purpose fitting mount which attaches to the photo stand.

### ■ Simple Trans Illuminator Base VL-DIA-A

### ■ Frosted Glass Plate VL-DIA-F

### ■ Trans-Illuminator Base X-DE

### ■ Epi-Illuminator PM-LSD2 (2 pieces, 1 set)

### ■ Trans-Illuminator LSD

### ■ Filters (LB45, 100, 200, Y48, G53.3, ND6, 12, 50)

### ■ Stage Glass (transparent and opaque white)

### ■ Stage Plate 45φ (black metal finish)

### ■ Stage Plate 28φ (black metal finish)

### ■ Mechanical Stage FM

### ■ Shade Stage Plate (with 2 shutter interrupters)

### ■ Polarizing Filter SZ-PO-P

### ■ Analyzing Filter PM-POL20, 38, 80

### ■ Lieber Kühn Reflector PM-LM 20, 38

### ■ Incident Illuminator Mirror Housing PM-EL 20, 38, 80

### ■ Objective Lens Mount PM-MTob

### ■ Macrophotographic Equipment PMT-35

Consisting of 27 units



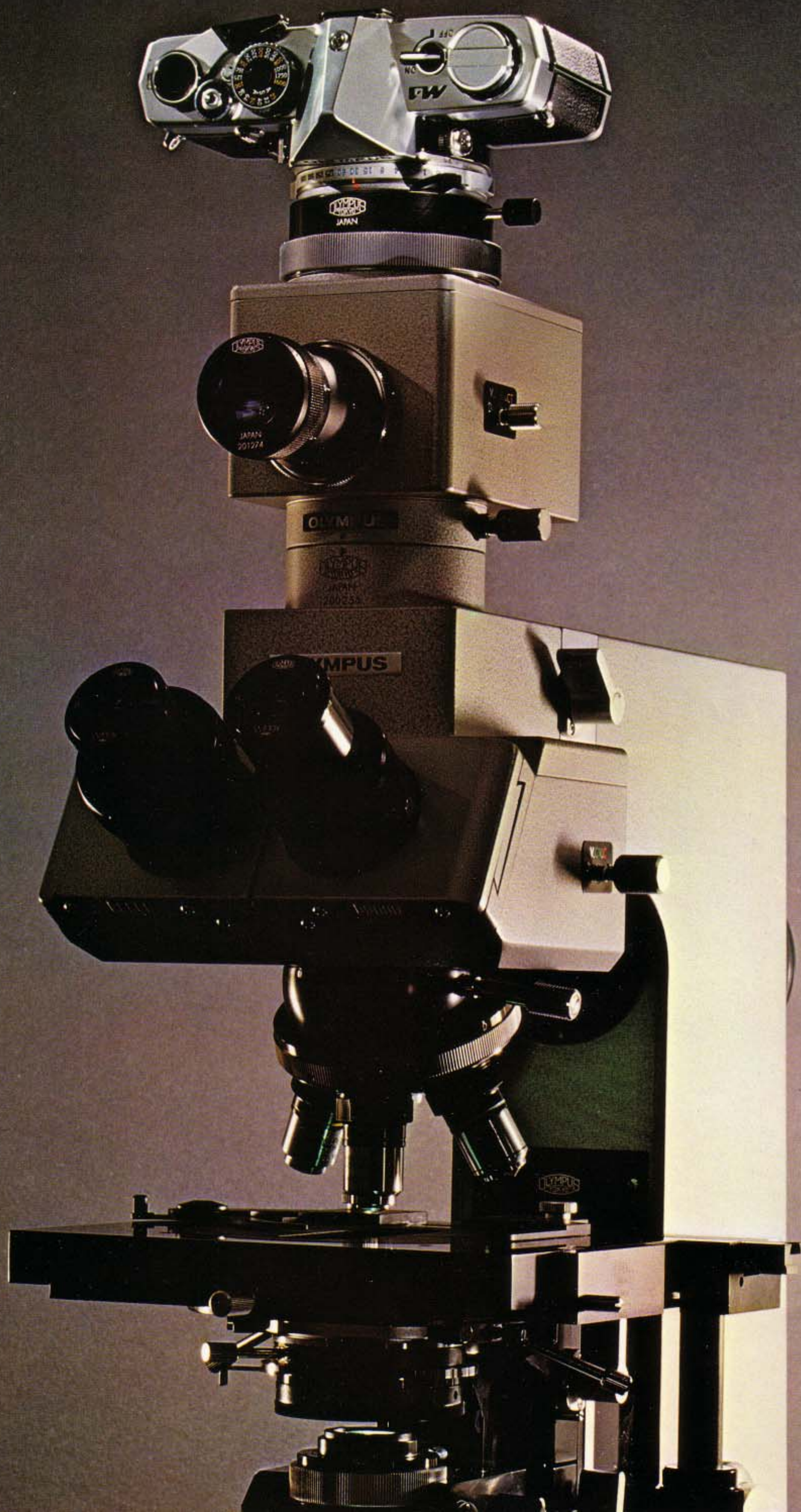





## Photomicrography group

Olympus has a world-wide reputation as a manufacturer of high quality microscopes and a wide range of microscope accessories. Building on this experience with ultra-precision technology, Olympus created the photomicrography group of the M-System. It includes special shut-

ters and massive supporting stand to prevent vibration at high magnifications, automatic exposure equipment operated by electronic shutters and observation viewers plus every accessory required for the most demanding photomicrographic applications.

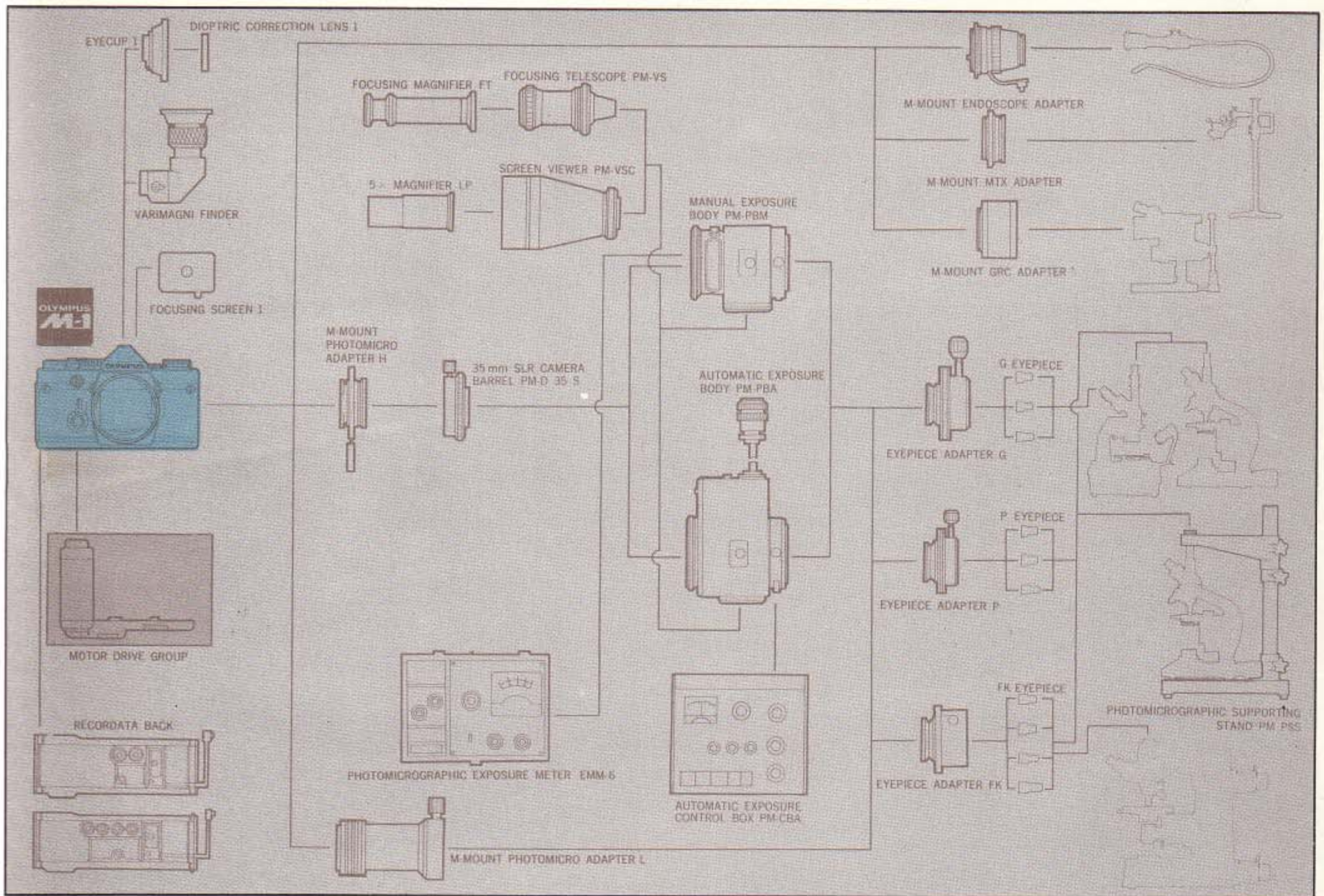

### ■ M Mount Photomicro Adapter L

An adapter for microscope photography which is fitted between the M-1 and the microscope. Used for relatively low magnification.

### ■ M Mount Photomicro Adapter H

An adapter used to fit the M-1 to the PM-PBA or the PM-PBM and the PMT-35.

### ■ 35mm SLR Camera Barrel PM-D35S

An adapter used to connect the M mount adapter H fitted to the M-1 with the PM-PBM.

### ■ Eyepiece Adapter G

### ■ Eyepiece Adapter P

### ■ Eyepiece Adapter FK

### ■ Automatic Exposure Body PM-PBA

Automatically determines the exposure of microscope photographs by means of an electronic shutter. Used in combination with the PM-CBA.

### ■ Manual Exposure Body PM-PBM

Features a special shutter construction that prevents shutter vibrations from affecting the microscope even at high magnifications.

### ■ Automatic Exposure Control Box PM-CBA

Controls the automatic exposure body PM-PBA with color temperature correction, etc. Eight types of filters are attached.

### ■ Photomicrographic Exposure Meter EMM-6

### EMM-6

### ■ Screen Viewer PM-VSC

Used for more exact focusing in photography

utilizing an objective lens of 4 times or less magnification.

### ■ 5X Magnification LP

### ■ Focusing Telescope PM-VS

Used for photography when an objective lens of more than 4 magnifications is used.

### ■ Focusing Magnifier FT

### ■ Photomicrographic Supporting Stand PM-PSS

A massive supporting stand for preventing vibrations during high magnification photograph.

### ■ M Mount Endscope Adapter

### ■ M Mount GRC Adapter

### ■ M Mount MTX Adapter



## Other units

### Recordata Back

A rear cover provides a method of incorporating into the photograph the date, number, alphabetic symbol, etc. This back Converts the M-1 into a data camera.

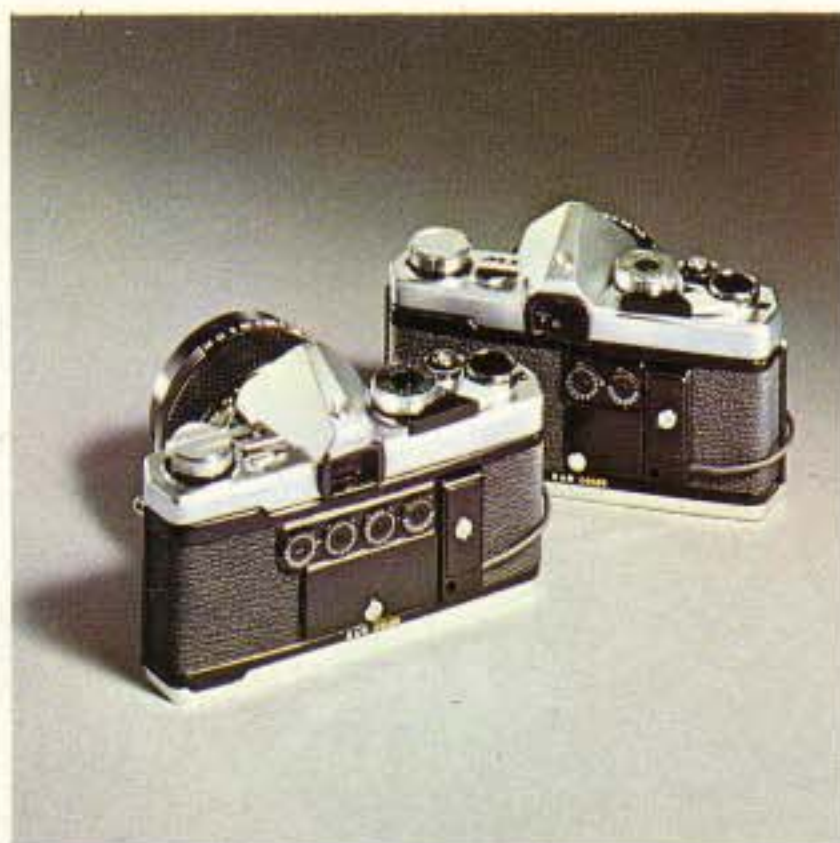

### Filters

Filters are fitted in front of the lens to absorb unnecessary light and thereby adjust the color value of the object photographed to coincide with the impression it produces on the human eye. They also correct the color balance of the color film that is being used.

The UV and 1A filters in particular can be used with color or black and white film not only to reduce atmospheric haze, but also to serve as a protection for the lens.

Olympus filters are made of special optical glass and designed to conform to the same high standards set for Zuiko lenses.

### Focusing Screens

Interchangeable Focusing Screens			
1-1 Microprism-matte type (for most lenses)	1-2 Microprism-matte type (for longer telephoto lenses)	1-3 Split Image-matte type	1-4 All matte type
1-5 Microprism-clear field type (for wide angle lenses)	1-6 Microprism-clear field type (for standard and telephoto lenses)	1-7 Microprism-clear field type (for super telephoto lenses)	1-8 All microprism type (for wide angle lenses)
1-9 All microprism type (for standard and telephoto lenses)	1-10 Checker-matte type	1-11 Cross Hairs-matte type	1-12 Cross Hairs-clear field type

※Specifications are subject to change.

### Lens Hoods 2.8/35, 1.8/50, 1.4/50

#### Lens Hood 1.2/55

Designed to prevent strong incident light from striking the lens surface and degrading the final image. Those for standard lenses are push-on types which can be reversed to fit snugly over the lens barrel and in this position will fit in the camera case.

Two types are sold separately, one for use with the wide angle 35mm F2.8 lens, standard 50mm F1.8 or 50mm F1.4 lenses, the other for use with the standard 55mm F1.2 lens.

### Accessory Shoe 1

This is fixed securely in place when installed by screwing it tightly into the M-1 shoe socket. It includes a cordless contact so an electronic flash or flashbulb unit can be conveniently used without cords.

#### OLYMPUS Flash CL

This cordless contact microflash is extremely compact and uses standard AG-1, AG-3N and AG-1B type bulbs.

Guide number (ASA 80)

- AG-1, AG-3N: 28 (90 in case of feet)
- AG-1B: 20 (65 in case of feet)

#### OLYMPUS PS 100G

The Olympus PS 100G Electronic Flash operates on penlight batteries and AC house current.

Contact: Hot shoe (center contact). Power Source: 2 pcs. 1.5V penlight batteries. Carbon/zinc or alkaline. AC house current 100-120V or 220-240V. Guide Number: 14 (45 in case of feet). (ASA 80). Color Temperature: 6,000° Kelvin. Coverage Angle: 50° vertical, 60° horizontal. Flash Duration: 1/1000 sec. Number of Flash: 200 flashes from set of fresh alkaline batteries. Size & Weight: 86 × 59 × 29mm, 120gr. (3 3/8 × 2 3/8 × 1 1/8 in., 4 oz.)

\* not available in us market

#### M Mount Astroscope Adapter

An adapter for attachment of the M-1 to astronomical telescopes.

Item	Color	Use
For Black and White and Color	Skylight (1A)	Color-less Cuts out ultra violet light which degrades color renditions and prevents a greenish cast in color pictures taken in the shade.
	L39 (UV)	Color-less Cuts out harmful ultraviolet light. Recommended for protecting the camera lens.
	ND2	Gray Neutral density filter. Cuts light intensity by 1/2
	ND4	Gray Neutral density filter. Cuts light intensity to 1/4
	POL. (polarizing)	— Reduces reflected light and light from sky.
For Black and White	Y48 (Y2)	Yellow Increases contrast in a picture by darkening blue sky and emphasizing clouds.
	O56 (O2)	Orange Produces a higher contrast than the Y2.
	R60 (R1)	Red Produces an even stronger contrast than the O2 and is especially effective for distant subjects.
For Color	A4 (81C)	Amber For use in overcast or rainy weather. Reduces green to produce natural color pictures.
	B4 (82C)	Blue For use in early morning or late at night to reduce excessive red and produce natural color pictures.



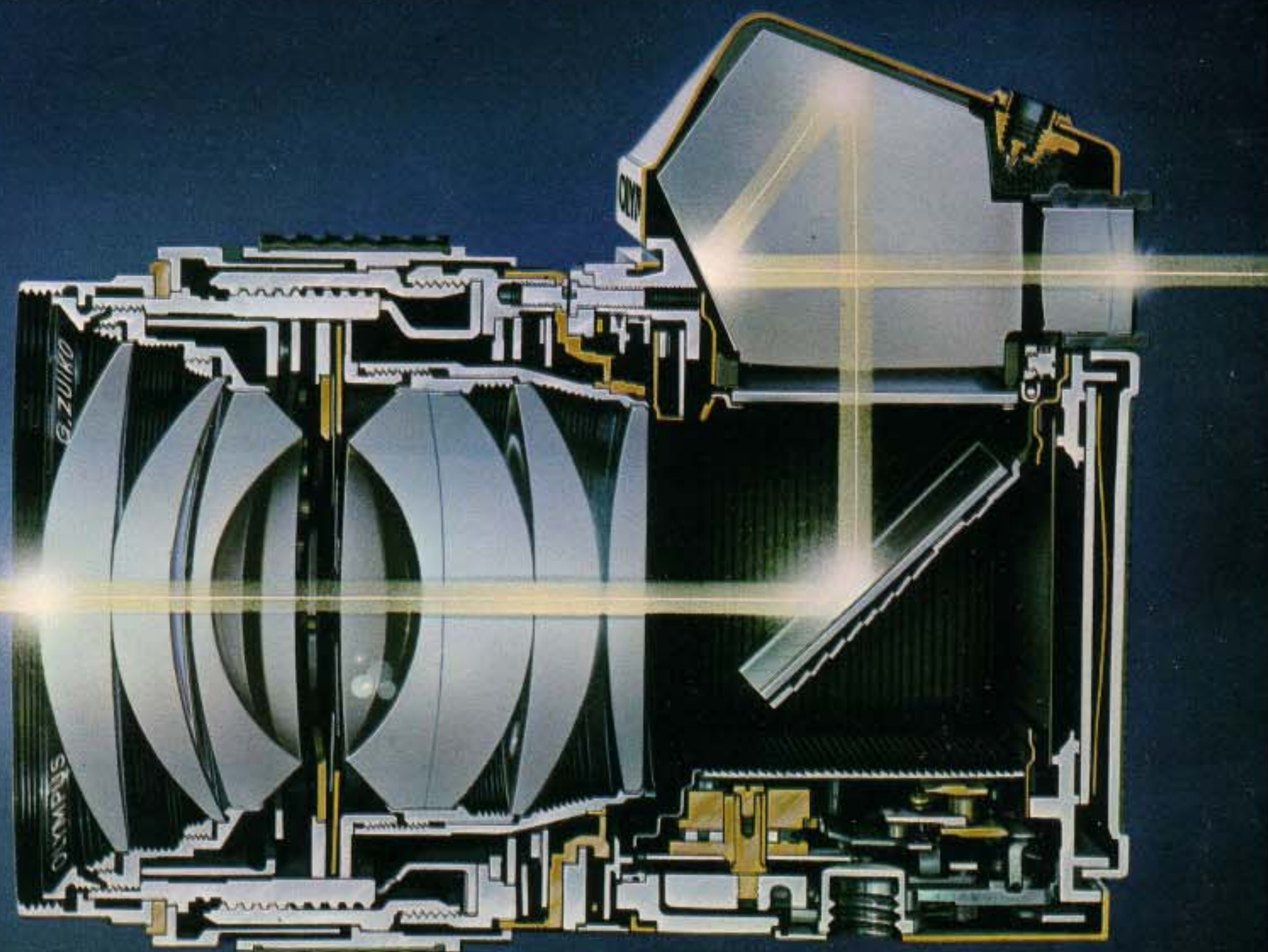

### Specifications

System:	OLYMPUS M SYSTEM consisting of approximately 280 units	Viewfinder Magnification:	0.92X at infinity with standard 50 mm lens
Camera Type:	35 mm Single-Lens Reflex with focal plane shutter	Viewfinder Apparent Field View:	23°30' & 35°
Film Size and Capacity:	35 mm perforated film in 20 or 36 exposure cartridges; removable hinged back accepts 250 exposure back and Recordata back (optional accessories)	Focusing Screen:	1-1 Microprism-Matte Type provided. Interchangeable with any of 11 additional screens available
Film Format:	24 mm x 36 mm	Reflex Mirror:	Oversize, instant return type with mirror lock-up control
Standard Lenses:	50 mm F1.8 F Zuiko Auto-S 6 elements in 5 groups 50 mm F1.4 G Zuiko Auto-S 7 elements in 6 groups 55 mm F1.2 G Zuiko Auto-S 7 elements in 6 groups	Flash Contacts:	X and FP with switch
Lens Mount:	OLYMPUS M Mount, bayonet type	Flash Synchronization:	With electronic flash (X) 1 to 1/60 sec. With Class "M" bulbs (X) 1 to 1/15 sec. With Class "F" bulbs (X) 1 to 1/15 sec. With focal plane bulbs (FP) 1/60 to 1/1000 sec.
Minimum Focusing Distance:	45 cm (17 <sup>3</sup> / <sub>4</sub> " ) with all standard lenses	Hot Shoe Socket:	Built-in. Easy to attach OLYMPUS hot shoe available
Lens Accessory Size:	49 mm threaded for F1.8 and F1.4 lenses; 55 mm threaded for F1.2 lens	Film Advance:	Ratchet type film advance. May be advanced in one stroke or several short strokes for a total of 150° rotation. Built-in prevention against double advance with double exposure override capability
Shutter:	Focal plane shutter, dial mounted control, with speeds from 1 to 1/1000 second plus B	Film Loading:	OLYMPUS easy load system
Self-Timer:	4-12 second delay lever type; can be stopped after actuation	Exposure Counter:	Progressive type from "S" (Start) to 36 and "E" (End). Counter automatically resets to "S" when rear cover opened
Exposure Measurement:	Two highly-sensitive CdS cells located on either side of the eyepiece provide through-the-lens open aperture light measurement. Match needle setting visible in viewfinder. On/Off Switch located atop camera.	Film Rewinding:	Rewind crank with automatic resetting rewind release lever
Exposure Range:	EV 2-17 (ASA 100 with F1.4 standard lens)	Rear Cover:	Removeable hinge type. Interchangeable with Recordata Back and 250-Film Back
Film Speed Range:	1.3 volt mercury battery (Eveready E625, Mallory RM625-R, GE No. 625 or equivalent) ASA 25-1600	Dimensions:	With F1.8 lens: 136 mm x 83 mm x 81 mm (5 <sup>3</sup> / <sub>8</sub> " x 3 <sup>1</sup> / <sub>4</sub> " x 3 <sup>3</sup> / <sub>16</sub> " ) With F1.4 lens: 136 mm x 83 mm x 86 mm (5 <sup>3</sup> / <sub>8</sub> " x 3 <sup>1</sup> / <sub>4</sub> " x 3 <sup>3</sup> / <sub>8</sub> " ) With F1.2 lens: 136 mm x 83 mm x 97 mm (5 <sup>3</sup> / <sub>8</sub> " x 3 <sup>1</sup> / <sub>4</sub> " x 3 <sup>13</sup> / <sub>16</sub> " ) Body only: 136 mm x 83 mm x 50 mm (5 <sup>3</sup> / <sub>8</sub> " x 3 <sup>1</sup> / <sub>4</sub> " x 2" )
Viewfinder:	Pentaprism type wide-vision finder shows 97% of actual picture field; interchangeable focusing screen; visible exposure meter needle	Weight:	With F1.8 lens: 660 gr. (23.3 oz.) With F1.4 lens: 720 gr. (25.4 oz.) With F1.2 lens: 800 gr. (28.2 oz.) Body only: 490 gr. (17.3 oz.)

Specifications subject to change without notice.





**OLYMPUS**

**OLYMPUS OPTICAL CO., LTD.**

TOKYO, NEW YORK, HAMBURG

