

OLYMPUS



WINDER 1

■ OPERATING INSTRUCTIONS

Your new Winder 1 is designed to enhance the "speed" — the first requisite to 35mm SLRs — to capture the subject at the right moments.

The Winder 1 automatically advances the film one full frame and cocks the shutter in about 0.3 sec. whenever its shutter release is pressed. It not only saves you from distracting, time-consuming manual film winding, but also offers you enjoyment of pursuing criti-

cal shutter chance that may otherwise be lost.

This manual uses the OM-2 in the illustrations but, of course, the Winder 1 can be attached to and operated with the OM-1 camera in exactly the same manner.

For various OM System motor drive units, see the Manual for Motor Drive Group.

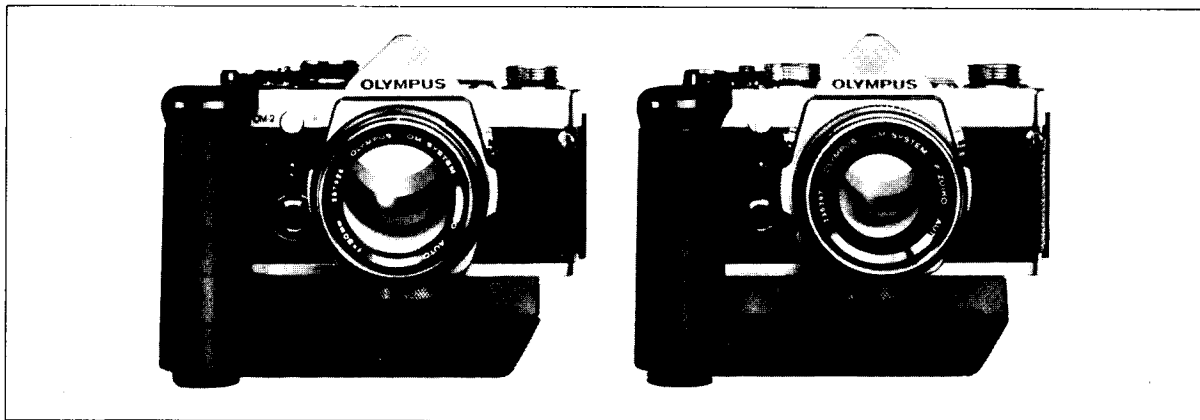

- **Camera:** OM-1 and OM-2 cameras.
- **Film advance:** Single-release shooting, instant film wind after each exposure.
- **Operational cycle:** Approx. 0.3 sec.
- **Shutter Speed:** *OM-1* 1 to 1/1000 sec. *OM-2* (AUTO) Approx. 60 to 1/1000 sec. (MANUAL) 1 to 1/1000 sec.
- **Power supply:** Four 1.5V AA (penlight) size batteries, including Ni-Cd rechargeable batteries; a jack for external power source is built in.
- **Battery loading:** Snap-in, magazine-type M. 6V Battery Holder 1.
- **Input voltage:** DC 4–6V (DC 4–5.5

V in case of external power source with large potentiality).

- **Capacity:** Approx. 20 rolls of 36-exposure film with a set of fresh Manganese batteries; approx. 50 rolls with Alkaline batteries; approx. 15 rolls with Ni-Cd rechargeable batteries, at normal temperature.
- **Film:** 12-, 20- and 36-exposure roll films, and up to 250 exposures on 10m (33 ft.) bulk load film using 250 Film Back 1.
- **Connection with remote control apparatus:** Via a 2.5mm mini-jack.
- **Mounting to camera:** Clamping screw

through camera's tripod socket, a guide pin provided.

- **Shutter release:** Push-button type on hand grip.
- **Coupling to 250 Film Back 1:** Automatic direct contact via coupling gears, provided with gear cover and automatic film wind stop contact.
- **Film end stop:** Solid-state circuit for automatic film wind stop after last exposure.
- **Dimensions:** 130 x 64 x 100mm (5 1/8 x 2 1/2 x 3 7/8").
- **Weight:** 290gr. (10.2 oz) (less batteries).

OM DESCRIPTION OF CONTROLS

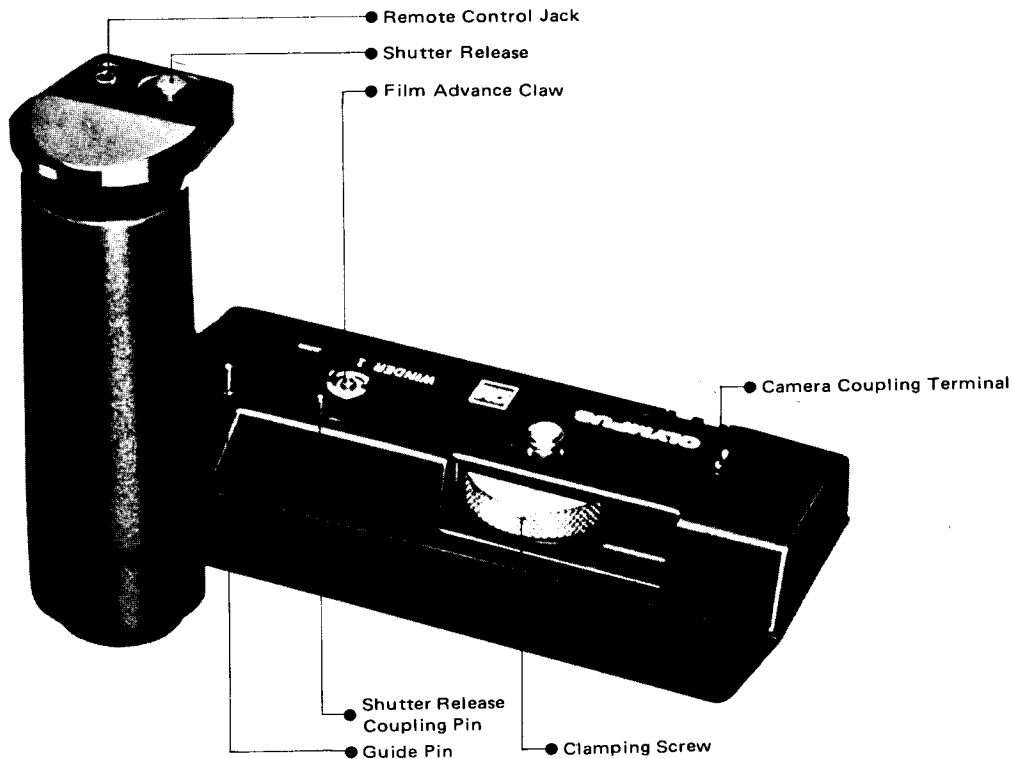



● 250 Film Back
Coupling Terminal

250 Film Back Coupling Gear ●

Gear Cover ●

Strap Eyelet ●

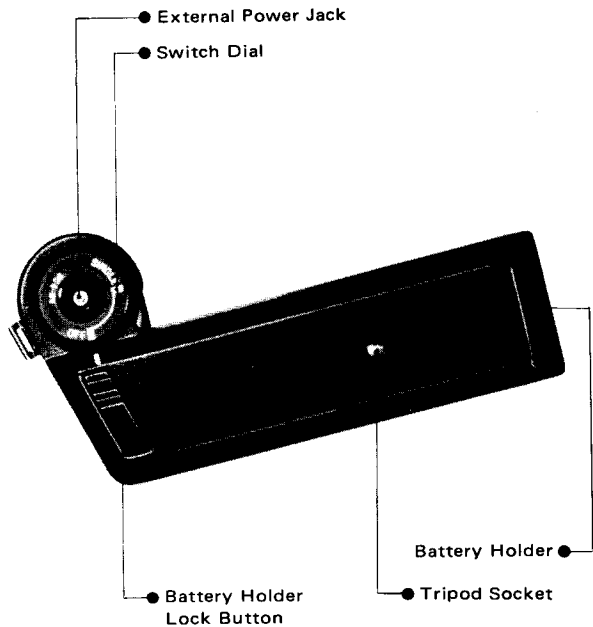

● External Power Jack

● Switch Dial

● Battery Holder
Lock Button

Battery Holder ●

● Tripod Socket

OM ATTACHING TO THE OM CAMERA BODY

The Olympus OM-1 and 2 are designed for motor drive use. The base plate is provided with 1) Battery Chamber, 2) Motor Coupling Section, 3) Motor Coupling Terminal, 4) Guide Pin Hole and 5) Tripod Socket.

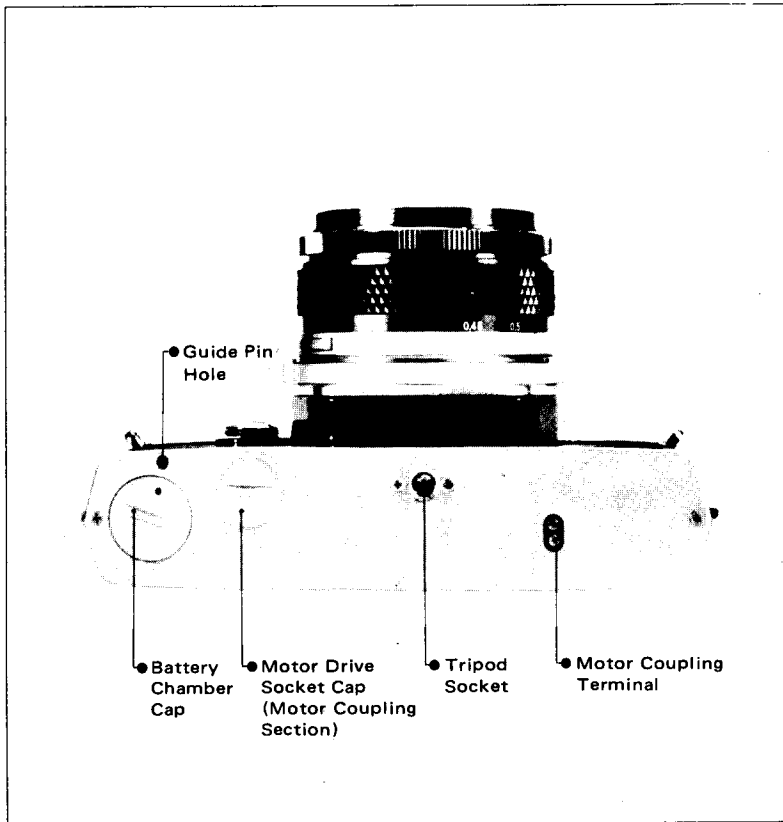

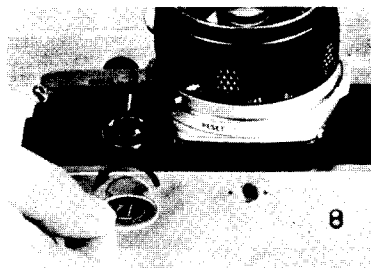

1. Remove the motor drive socket cap from the camera base plate by rotating it counter-clockwise with a coin until the index dot of the cap is aligned with the index dot of the camera.

* Store the socket cap in the Winder 1 to avoid loss (see page 8).

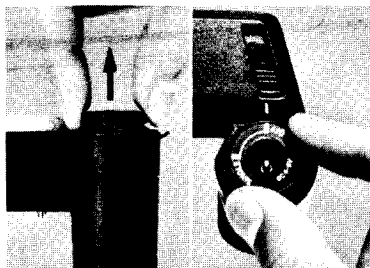

2. Pull up and rotate the Switch Dial to the "OFF" position. Release the dial making sure that the dial is securely in place and does not move.

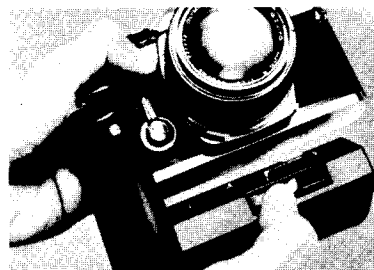

3. Insert the Guide Pin into the guide pin hole on the camera base plate, and the Clamping Screw into the tripod socket. To assure proper connection, adjust the position of the Winder 1 until it is flush with the camera.

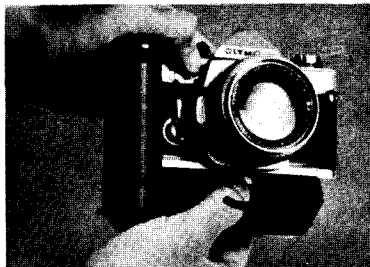

4. Turn the Clamping Screw clockwise until the Winder 1 is securely attached to the camera base plate.

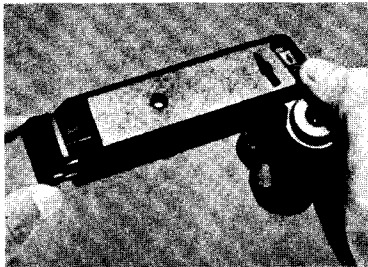

1. Slide the Battery Holder Lock Button on the bottom of the Winder 1 in the direction of the arrow: the Battery Holder will spring out of the compartment slightly for easy removal. Pull out the Battery Holder.

* The Socket Cap Storage is positioned at the underside of the entrance of the Battery Holder Compartment.

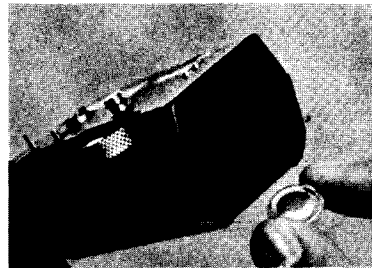

2. Insert and push horizontally the removed motor drive socket cap into the Socket Cap Storage with its claws facing up.

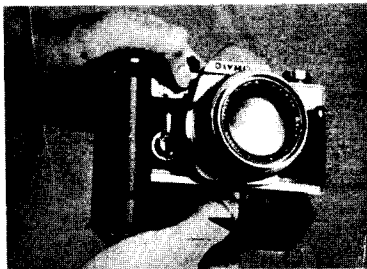

1. To detach the Winder 1, turn the Clamping Screw counter-clockwise.

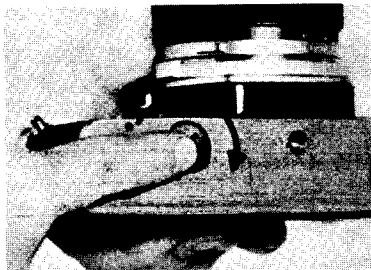

2. Retrieve the motor drive socket cap from the Socket Cap Storage.
3. To replace the cap on the camera base plate: Align the index dot on the cap with the index dot on the camera, press and turn the cap clockwise with your finger to engage the thread. Then continue turning with a coin until the groove on the cap is aligned with the index dot on the camera.

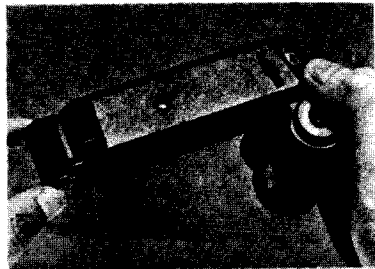

1. Pull out the Battery Holder (see page 8).

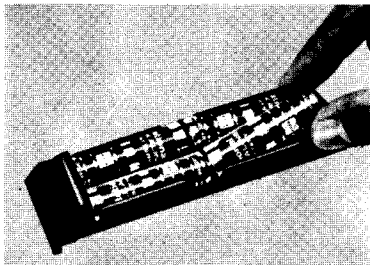

2. Insert four 1.5V AA (Penlight) size batteries into the Battery Holder as indicated by the polarity marks \oplus and \ominus , pushing against the spring.

* If the batteries are inserted upside-down, the motor will not function. (The polarity protection mechanism interrupts current flow.)

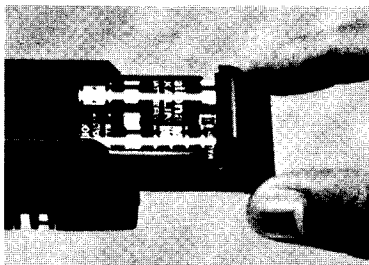

3. Insert the Battery Holder back into the compartment until it snaps into place. The Battery Holder Lock Button will automatically reset itself to the lock position.



4. Three types of batteries are available on the market — Manganese, Alkaline and Ni-Cd rechargeable batteries. The numbers of 36-exposure film that can be taken with a set of fresh batteries are:

Manganese	— approx. 20 rolls
Alkaline	— approx. 50 rolls
Ni-Cd	— approx. 15 rolls

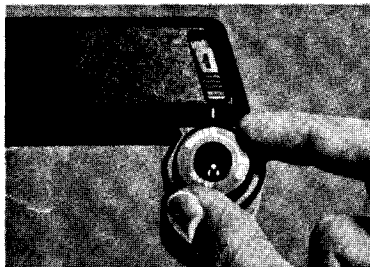

1. Pull up and rotate the Switch Dial to the "SINGLE" position. Release the dial, making sure that it is securely in place and does not move.

* The Switch Dial can be locked in two places other than "SINGLE" and "OFF". In actual use, set the dial to the indexed positions only.



2. Press the Shutter Release to take pictures.

* Before loading the camera with film, run several blank shots by pressing the Shutter Release to make sure the units are attached properly.

* Should you wish, you can manually transport the film advance lever and press the camera's shutter release even with the Winder 1 attached. The film can then be advanced manually or with the motor for the next shot.

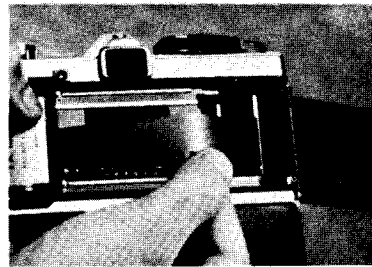

1. Always try to load your camera after the Winder 1 has been attached.

This eliminates even the remotest possibility of light leak through the motor drive socket. If this is not possible, attach the Winder 1 in a dimly-lit area.

2. Load the camera with film in the normal manner. (Refer to your Olympus OM Camera Instructions.)

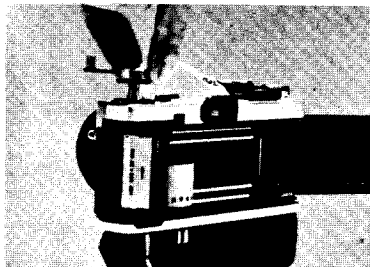

Unload the film in the normal manner.
(Refer to your Olympus OM Camera
Instructions.)

■ **HELPFUL HINTS**

● **IF THE WINDER 1 STOPS DURING
PICTURE TAKING**

1) Check the exposure counter. The
Winder 1 automatically stops advanc-
ing after the last frame is exposed.
Rewind the film into the cartridge.

IMPORTANT: After the last frame is
exposed, avoid pressing the Shutter
Release to prevent the possibility of
film damage.

2) If the Winder 1 stops in the middle
of a roll and makes a droning sound,
the batteries are exhausted. Turn the
Switch Dial to "OFF" and insert fresh
batteries.

● **SHOOTING IN LOW TEMPERA-
TURE AREAS**

1) If the Winder 1 will not advance
when shooting in extremely cold tem-
peratures, advance the first frame man-
ually and then use the motor.

2) If the Winder 1 will still not func-
tion, the batteries are exhausted or the
temperature is too low; replace the
batteries with fresh ones or warm the
units.

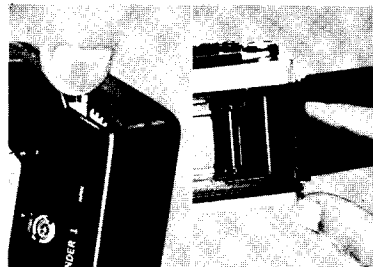

The OM System 250 Film Back 1 pro-
vides up to 250 exposures on 10m (30
ft.) lengths of bulk load film.

The outline of its operating procedures
is described in the followings.

1) Shift the Gear Cover on the 250
Film Back Coupling Gear to reveal the
gears.

2) Replace the standard camera back
with the 250 Film Back 1. The Film
Back can conveniently be attached to
the camera before or after the Winder
1.

3) Set the subtractive-type exposure
counter manually.

OM SIMULTANEOUS MULTIPLE MOTOR DRIVE PHOTOGRAPHY

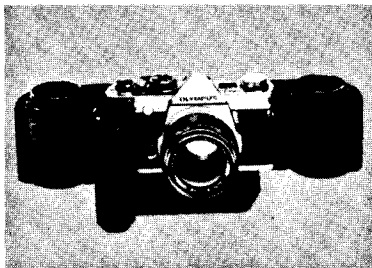

4) The 30m (100 ft.) film is taken out of its storage can, rolled round the supply-spool, cut at the desired lengths and put in the 250 Film Magazine, which along with the take-up magazine, is installed into the 250 Film Back 1. (For details see Operating Instructions for 250 Film Back 1.)

* The 250 Film Loader is available to make film spooling from the 30m film fast and easy.

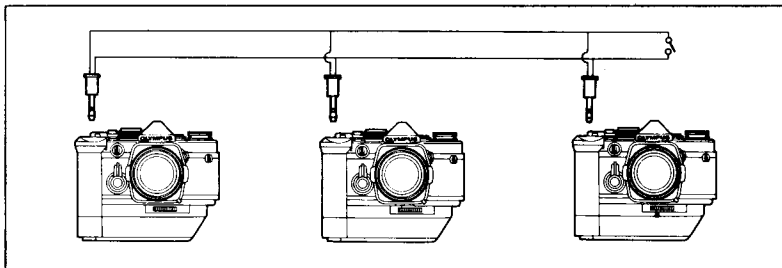

The Remote Control Jack on top of the handgrip of the Winder 1 provides a facility for electric shutter release in simultaneous bursts with two or more motorized OM cameras. The wiring is illustrated above.

* Prior to the wiring, set the Switch Dial to "OFF"; if set to "SINGLE", the Winder 1 may start functioning as soon as the connection is made.

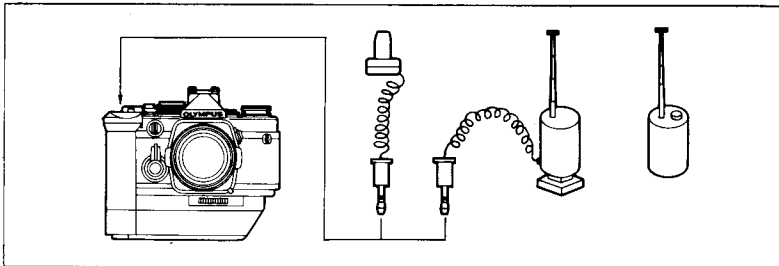

1. The Remote Control Jack provides a facility for remote motor drive photography. The jack accepts a 2.5mm mini-plug (output terminal of remote control apparatus).

* When inserting the mini-plug into the jack, the Switch Dial should be set to "OFF"; otherwise the Winder 1 may start functioning as soon as the connection is made.

2. Commercially available remote control apparatus, such as radio- or photo-control devices, self timers, intervalometers and remote control cords are applicable.

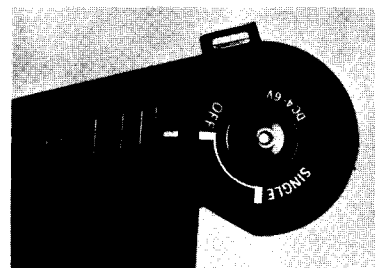

1. The External Power Jack at the center of the Switch Dial accepts the power plug from an external power unit of up to DC 6V (4–5.5V with a power unit of large potentiality).

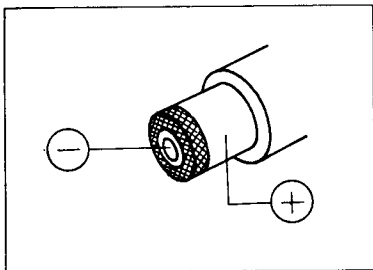

2. Connect the power plug with the jack referring to the illustration above.

Extremely low temperatures may cause the battery power to drop and the Winder 1 may fail to function normally. To prevent voltage drop, tuck the external power unit in your pocket and connect it with the Winder 1 via the remote cord.

* Ni-Cd batteries may supply enough power even at around 0°C. (At purchase of Ni-Cd batteries, it is recommended to get four pieces of them packaged as a set.)

- Make sure the Winder 1 is attached to the camera securely. Do not apply excessive force.
- Do not apply force when the movable parts have been stopped by the safety mechanism.
- After shooting with the Winder 1, always turn the Switch Dial to "OFF".
- Keep all electrical contacts clean and well away from metallic objects to prevent short circuit.
- At sub-zero temperatures, the batteries may sometimes fail to function normally. Warm them up before use.
- Do not hit or drop the Winder 1, or let it strike any hard object.
- When storing the Winder 1 for long periods, remove the batteries from the Battery Holder for longer battery life.
- Avoid storing the Winder 1 in very cold, hot or humid areas.
- Do not store the units near mothballs or similar materials to avoid the possibility of damage to metal surfaces.
- If cleaning is necessary, wipe the units with a soft cloth only. Do not use cleaning solvents or other harsh chemicals.



OLYMPUS

OLYMPUS OPTICAL CO., LTD.

43-2 Hatakeya 2-chome, Shibuya-ku, Tokyo, Japan