



E

OLYMPUS **OLYMPUS**
OM-2 **INSTRUCTIONS**

To an OM-2 Owner

The OM-2 is a unique 35mm single lens reflex, utilizing the Olympus TTL Direct (Off-the-Film) Light Measuring System for unprecedented accuracy of automatic exposure.

In addition, it offers full manual exposure control at the flip of a lever switch. OM-2 has set a new standard for reliability and versatility in a compact SLR, to meet the demands of the professional and amateur alike, for standard as well as scientific and technical photography pursuits.

OM-2 is part of the total Olympus OM System, enabling you to capture life as it happens, from photomicrography to astrophotography, from photojournalism to portraiture. With its many system components, the OM-2 permits an infinite range of photographic capabilities ... a camera that grows as your needs expand. To get the optimum results from your OM-2, carefully study this Owner's Manual. It is well worth your time, and will provide a sound basis for years of fine OM-2 photographs.

DESCRIPTION OF CONTROLS

Refer to pages in parentheses for detailed explanations of each part.

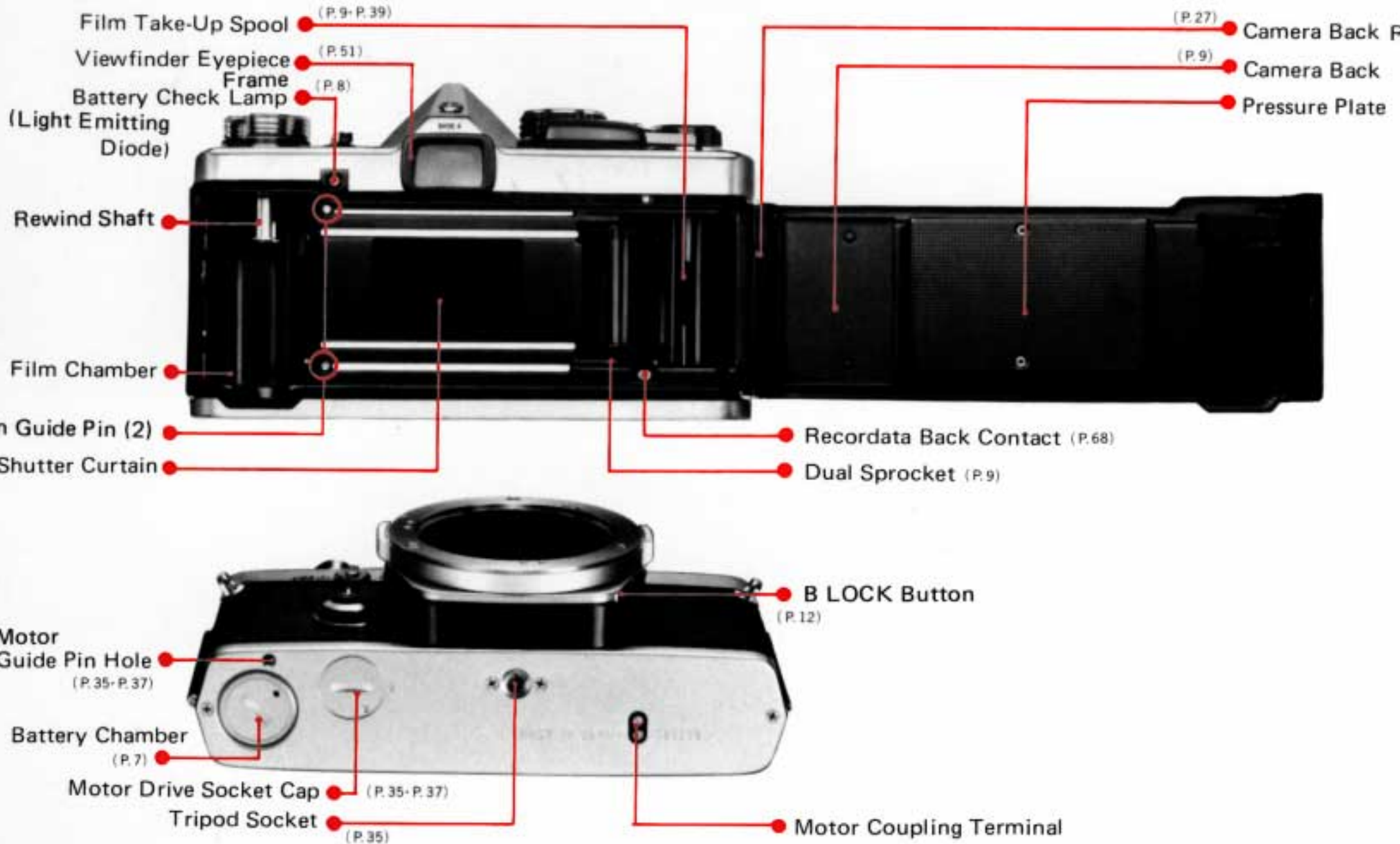

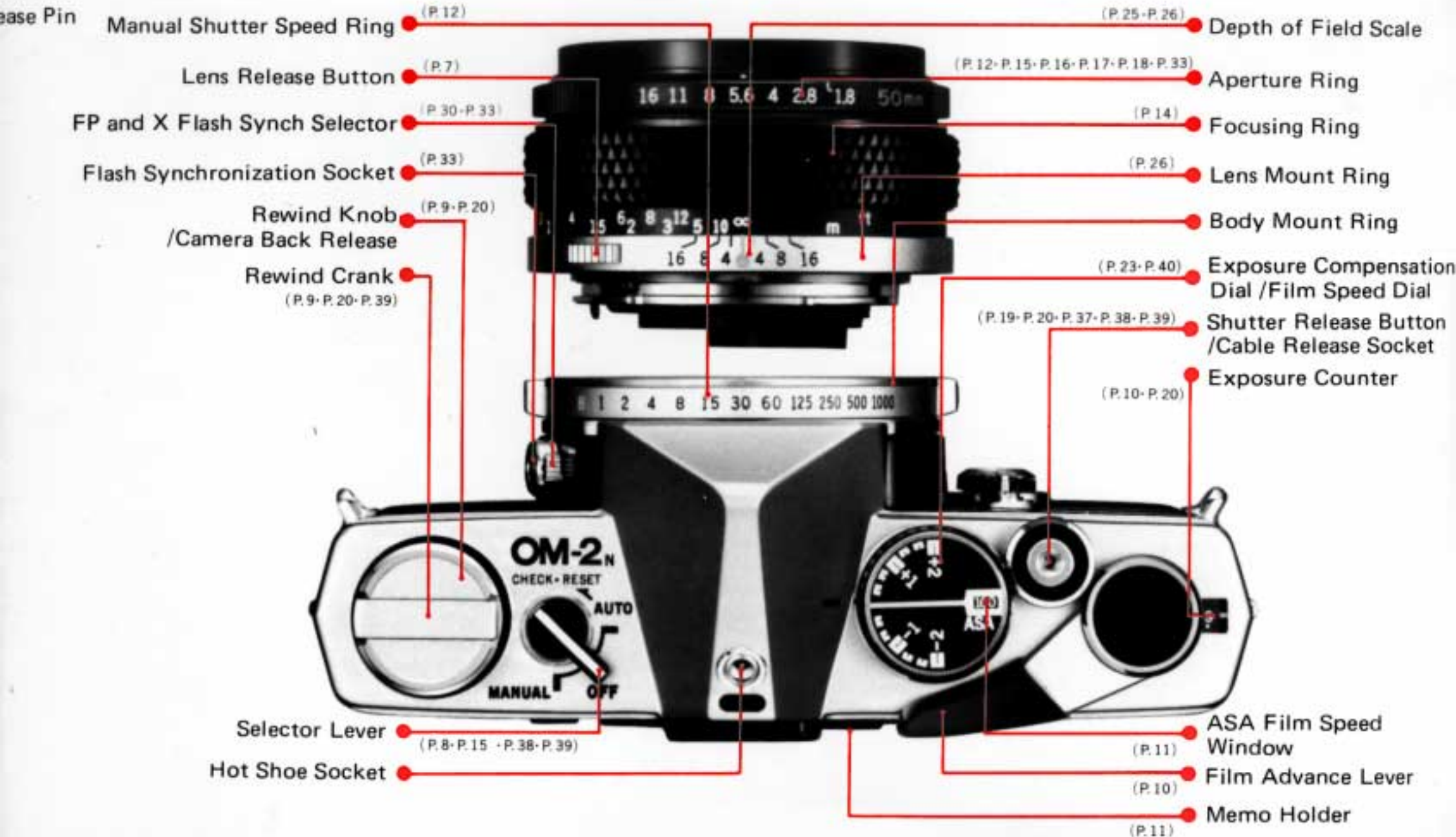

For easy reference, keep these pages unfolded while you are reading the instructions on the following pages.
The OM-2 camera body is illustrated with the 50mm F1.8 lens.



Rewind Release Lever (P. 20-P. 39)

Shoulder Strap Eyelet



Self-Timer (P. 21-P. 39-P. 40)

Depth-of-Field Preview Button (P. 25-P. 26-P. 40)

(P. 7) Lens

TABLE OF CONTENTS



● To an OM-2 Owner	1	● Flash Photography with an Electronic Flash Unit Other Than the T20/Flashbulb Photography . . .	33
● Description of Controls	2	● Motor Drive Photography	34
● Main Specifications	6	● Winder 1 Operation	37
● Mounting the Lens/Inserting the Batteries	7	● Care and Storage	38
● Battery Check and Mirror Lock-Up	8	● Questions and Answers	39
● Loading the Film	9	● The Most Important Feature of the OM-2 — TTL Direct (off-the-film) Light Measuring	41
● Operating the Film Advance Lever/Exposure Counter	10	● OM System	44
● Setting the ASA Film Speed Dial	11	● Zuiko Interchangeable Lens Group	45
● Aperture Ring and Manual Shutter Speed Ring	12	● Table of Interchangeable Lenses	47
● Setting the Selector Lever/Viewfinder	12	● Interchangeable Lens Group Units	49
● Focusing	14	● Finder Group	50
● Automatic Exposure Control	15	● Finder Group Units	51
● Manual Exposure Control	17	● Flashphoto Group	53
● Holding the Camera	19	● Flashphoto Group Units	55
● Unloading the Camera/Making Multiple Exposures	20	● Motor Drive Group	59
● Setting the Self-Timer	21	● Motor Drive Group Units	62
● Exposure Compensation	22	● Phototechnical Group	64
● Exposure Compensation for Automatic Measurement	23	● Phototechnical Group Units	68
● Exposure Compensation for Manual Measurement	24	● Macrophotography Group	69
● Depth of Field	25	● Macrophotography Group Units	72
● Depth of Field Scale/Preview Button	26	● Photomicrography Group	77
● Infrared Photography/Camera Back Replacement	27	● Photomicrography Group Units	80
● Interchangeable Focusing Screens	28	● Chart of Photographic Ranges	82
● Flash Photography with the T20 Electronic Flash	29	● Case Group and Units	83
● The T20/OM-2 Way — Flash Photography Couldn't Be Simpler and More Accurate	32		

MAIN SPECIFICATIONS

Specifications subject to change without notice



System: OLYMPUS OM System.

Camera type: 35mm Single Lens Reflex with automatic exposure control electronic focal plane shutter.

Film format: 24mm x 36mm.

Lens mount: OLYMPUS OM Mount, bayonet type; rotation angle 70°, flange back focus distance 46 mm.

Shutter: Focal plane shutter, automatic exposure control from 120 seconds to 1/1,000 second (ASA 100, F1.2, at normal temperature and humidity). Manual exposure: B, 1–1/1,000 sec., ring mounted control.

Synchro: FP·X switch type contact, incorrect flash prevention. (Accessory shoe mount for X contact)

Automatic exposure control: Aperture-preferred automatic exposure control electronic shutter type. TTL Direct (off-the-film) Light Measuring System. Measuring range: EV-6.5 to EV18 (at ASA 100 with F1.2 lens).

Exposure range: Shutter speeds from 120 sec. to 1/1,000 sec. (at normal temperatures and humidities). Light sensors: 2 SBC sensors. Large exposure compensation dial: ±2EV (within the ASA film speed range). Automatic flash exposure: Direct contacts for TTL Auto Flash (full automatic flash with T20 electronic flash).

Manual exposure: TTL type. Measuring system: Full aperture center-weighted metering. Measuring range: EV1.5–EV17 (ASA 100 with F1.2 standard lens). Light

sensors: 2 CdS sensors. Zero-method with needle visible in viewfinder.

Film speed setting: ASA 12–1600, set by lifting and rotating film speed dial.

Auto/Manual selection: By selector lever.

Power source: Two 1.5V silver oxide batteries [Eveready (or UCAR) EPX-76 or equivalent]

Battery check: 3-stage battery check lamp (light emitting diode) indicates full voltage, depleted charge, and exhaustion of batteries. Shutter lock to limit drainage.

Mirror unlock: Mirror lock-up can be released simultaneously with battery check.

Viewfinder: Pentaprism type wide-vision finder.

Focusing screens: Wide selection of interchangeable screens. Supplied with Focusing Screen 1–13 (microprism split image matte type).

Finder view-field: 97% of actual picture field.

Viewfinder magnification: 0.92X at infinity with 50mm lens.

Apparent field of view: Vertical 23° 30', horizontal 35°.

Indicators in viewfinder: 3-stage selector lever. (Auto: Shutter speed indicator. – Manual: exposure index. – Off: nothing). Exposure compensation marker. Charge/Auto check lamp (with T20 Electronic Flash mounted).

Reflex mirror: Oversize, quick return type (without lock-up).

Film loading: OLYMPUS easy loading. **Manual film advance:** Lever type with 150° angle for one long or several short strokes, pre-advance angle 30°, self-cocking, double advance and double exposure prevention.

Motor drive advance: With Motor Drive 1 unit attached, single frame and continuous advance at speed of 5-frame per second (at exposures above 1/500 sec., with fresh batteries and at normal temperature and humidity).

Exposure counter: Progressive type with automatic reset.

Film rewind: Crank type, with rewind release lever setting, automatic return.

Self-timer: 4–12 second delay lever type with 180° maximum angle can be stopped and reset after actuation.

Camera back: Removable hinge type, with memo holder. Interchangeable with Recordata Back 2 and 250 Film Back 1.

Hot Shoe socket: OLYMPUS special Accessory Shoe 4 supplied.

Dimensions and weights:

Body only: 136x83x50mm (5.35"x3.27"x1.97") 520g (18.3 oz)

With F1.8 lens: 136x83x81mm (5.35"x3.27"x3.19") 690g (24.3 oz)

With F1.4 lens: 136x83x89mm (5.35"x3.27"x3.50") 750g (26.5 oz)

With F1.2 lens: 136x83x97mm (5.35"x3.27"x3.82") 830g (29.3 oz)

MOUNTING THE LENS



Mount the Lens.

Align the red dots on the lens flange and the body mount ring. Turn the lens clockwise until the lens release button springs up and you will hear positive "click".

Lens Removal

To detach the lens, press down on the lens release button and turn the lens counter-clockwise. Always attach the front and rear lens caps when the lens is removed from the body to prevent any possibility of damage.

CAUTION: Do not apply pressure to the lens release button during the mounting procedure to assure proper coupling between the lens and the meter.

INSERTING THE BATTERIES



Insert two 1.5V silver oxide batteries (Eveready or UCAR, EPX-76 or equivalents) into the battery chamber.

CAUTION: Batteries should be always replaced as a pair. These batteries are used as a power source for the built-in exposure meter (MANUAL) and the automatic exposure control (AUTO). If battery polarity is incorrect, the camera does not function.



BATTERY CHECK AND MIRROR LOCK-UP



By pressing the selector lever to the "CHECK-RESET" position, you can check the batteries and/or unlock the mirror.

Check the Batteries.

Move the selector lever to the "CHECK-RESET" position. The battery check lamp indicates battery condition as follows:

- ① The red lamp lights brightly — Battery voltage is sufficient.
- ② The red lamp flashes on and off — Batteries are very weak. Fresh batteries are recommended.
- ③ The lamp does not light — Batteries are drained. Replace them.

NOTE: Silver oxide batteries will last approximately one year. To avoid battery drain, make it a point to switch off the selector lever when the camera is not used.

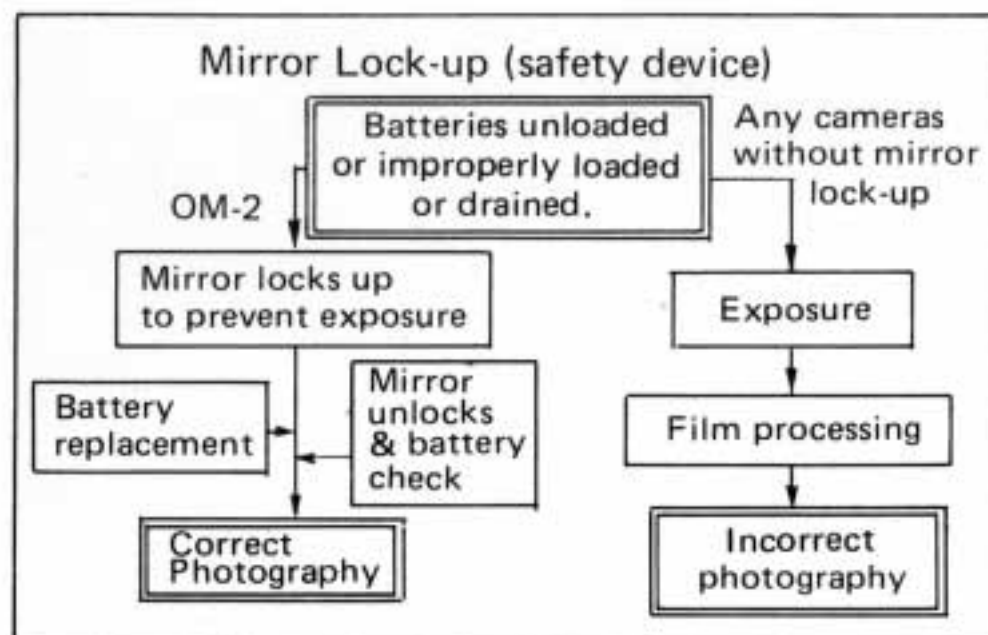

Mirror Lock-Up

If the mirror is up, the field of view turns dark through the viewfinder, and the film cannot be advanced. This lock-up of the mirror occurs when ① no batteries are loaded or batteries are depleted, or ② the film is advanced during exposure. The mirror lock-up does not indicate any breakdown of the camera, but a built-in safety device to prevent any trouble. Press the selector lever to the "CHECK-RESET" position, and unlock the mirror. In case ②, shooting can be resumed immediately. In case ①, replace batteries.

CAUTION: You cannot unlock the mirror after battery replacement, if you omit pressing the selector lever to the "CHECK-RESET" position.

NOTE: When the mirror locks up, a battery drain prevention device is activated to conserve power.

LOADING THE FILM

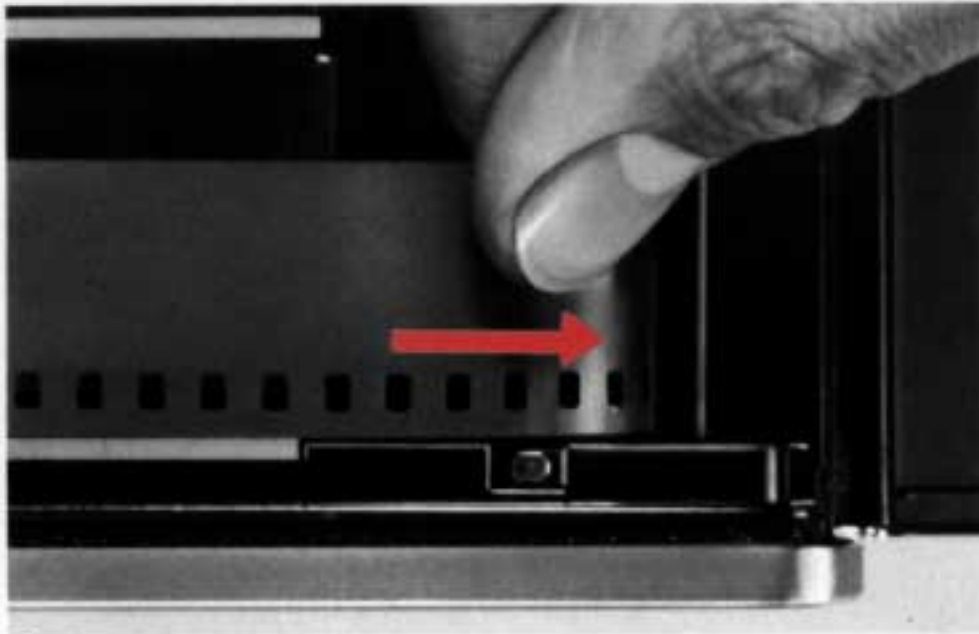

- ① Pull the rewind knob up and open the camera back.
- ② Insert a film cartridge into the film chamber and push the rewind knob back into the camera body.
- ③ Insert the film leader into one of the slots in the film take-up spool.

YES

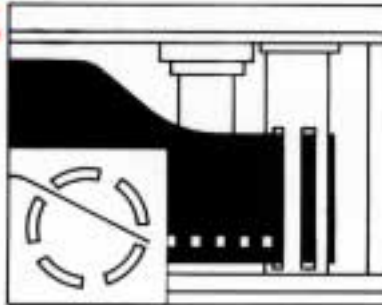

NO

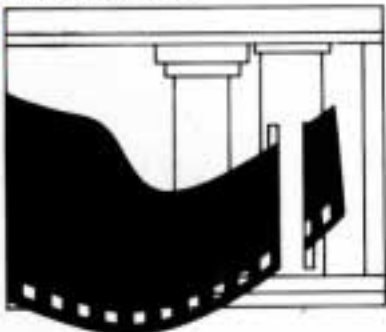

NO

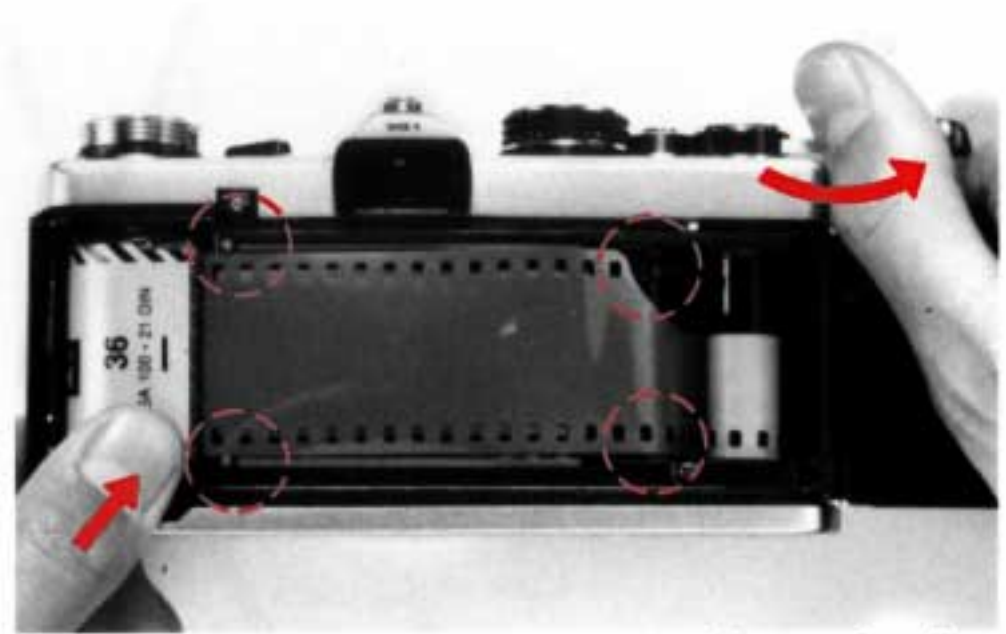
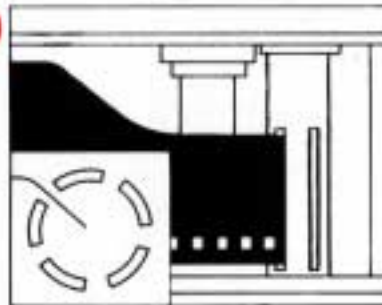

- ④ Turn the advance lever so that the film perforations engage the sprocket teeth.
- ⑤ Close the camera back until it clicks.
- ⑥ Make sure the selector lever is in the OFF position.

NOTE: Fold out the rewind crank and rotate it clockwise slightly to remove any slack in the film. Then if the rewind crank rotates as you turn the advance lever, the film is properly advancing.

OPERATING THE FILM ADVANCE LEVER



Turn the advance lever to the right as far as it will go. The film can be advanced by one frame, in a single stroke or in multiple short strokes.

NOTE: If the advance lever stops moving because you've shot the last remaining film frame while you are advancing the film, discontinue the film advance and rewind the film. (Read page 34 for motor drive shooting.)

EXPOSURE COUNTER

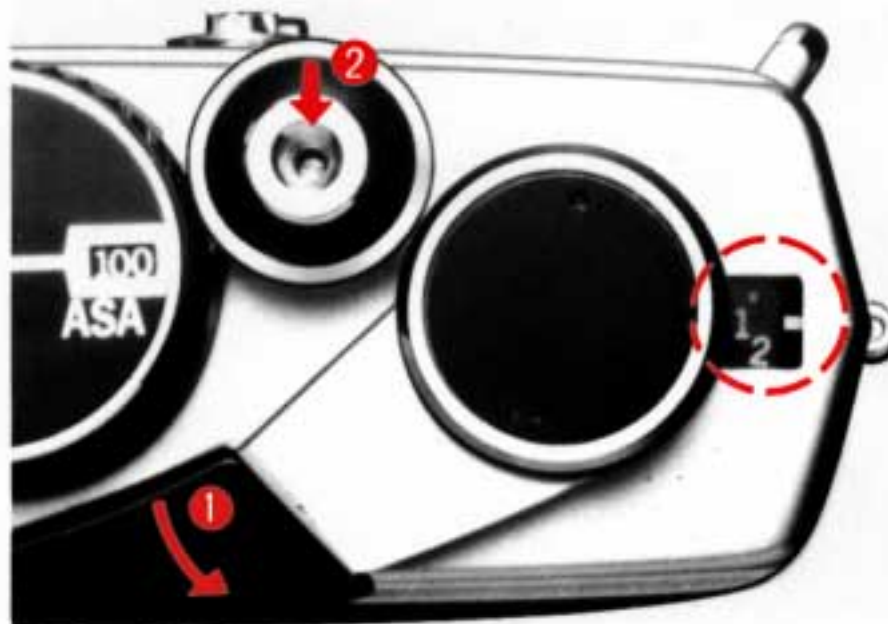

Exposure Counter

The exposure counter is indexed from "S" (Start) to 1, 2 ... up to 36 in even numbers and "E" (End). Whenever the camera back is opened, the exposure counter automatically returns to "S".

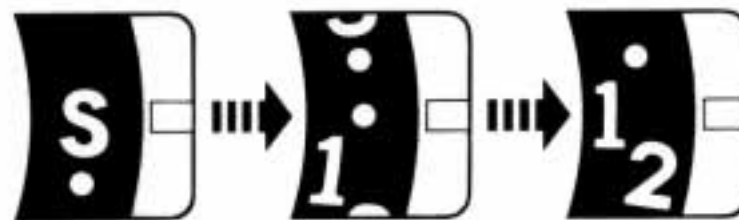

SETTING THE ASA FILM SPEED DIAL



Setting the correct ASA film speed on the camera is one of the most important factors in obtaining properly exposed pictures. To set the dial:

- ① Lift up the outer collar of the exposure compensation dial and rotate until the ASA speed for the film appears in the window.
- ② The ASA film speed scale on the dial is marked from 12 to 1600. If you are not able to rotate the outer collar to the desired ASA in one turn of the dial (only 3 stops can be rotated in one turn of the dial), release the collar and turn the exposure compensation dial several click stops in the opposite direction from the ASA you are trying to set. Then, lift the outer collar again and continue turning to the desired ASA setting. Repeat this procedure until the desired ASA can be seen in the dial window. NEVER FORCE THE DIAL WHEN SETTING ASA.

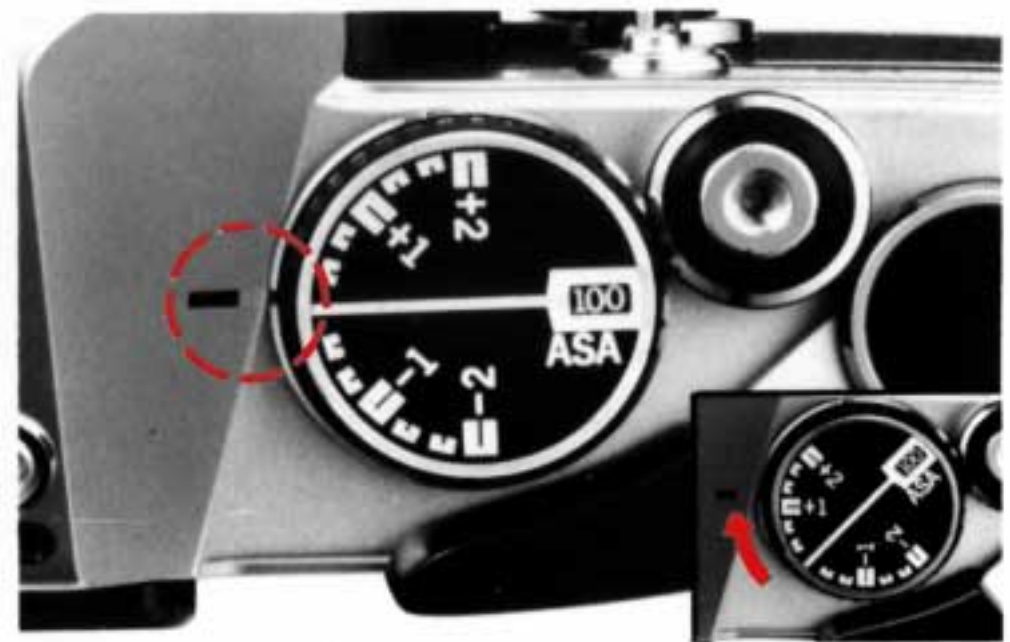

- ③ Once the setting has been made, turn the dial until the white line is aligned with the black index line on the pentaprism housing.

CAUTION: Make sure you align the white line with the black index line on the pentaprism after setting ASA; otherwise ASA is incorrectly set.

■ THE MEMO HOLDER

A memo holder is provided on the camera back. The holder accepts a memo slip or the end flap from most 35mm film packages as a reminder of ASA, exposure number, etc. This can be inserted from the bottom as shown in the photo.



APERTURE RING AND MANUAL SHUTTER SPEED RING

OLYMPUS
OM-2



Aperture Ring

The opening (aperture) in the lens diaphragm is marked in F stops on the aperture ring. The higher the F number, the smaller the lens opening (less light) and provides greater depth of field than lower F numbers (see page 25).

When setting the aperture ring, you may use either the click-stop positions or any in-between settings to obtain precise exposure control.

NOTE: All lenses in the OM System (except certain specialized lenses) provide fully automatic diaphragm control allowing you to focus and compose your picture with the lens fully open. The diaphragm will automatically close to the pre-selected F stop at the moment of exposure and immediately re-open when the exposure is completed.



Manual Shutter Speed Ring

Shutter speeds engraved on the manual shutter speed ring are used only for non-automatic camera operation with zero-method exposure measurement. These 12 shutter speeds are indicated as B, 1, 2, 4, 8 up to 1,000.

B indicates "bulb" at which setting the shutter will remain open as long as the shutter release button is held down. The other engravings indicate fractions of a second; for example "1" for 1 second, "2" for 1/2 second up to "1000" for 1/1000 second. To set at "B", rotate the ring while pressing the B LOCK button at the lower left of the body mount. Be careful that shutter speeds are set only at click stop positions.

NOTE: Under AUTO exposure control, irrespective of the shutter speed setting, the electronic shutter automatically selects the optimum shutter speed from about 120 seconds (ASA 100, at normal temperature and humidity) to 1/1000 second (except B, where the shutter works manually).

SETTING THE SELECTOR LEVER



The selector lever on top of your camera has four positions as follows (with click stops at AUTO—OFF—MANUAL):

- 1) **AUTO** — Automatic exposure control; you preset the F stop and the camera automatically sets shutter speed for proper exposure (see page 15).
- 2) **OFF** — Camera turned completely off to avoid battery drain. Always store your camera with the selector lever in this position.
- 3) **MANUAL** — Zero-method exposure operation; set shutter speed and F stop for proper exposure (see page 17).
- 4) **CHECK • RESET** — Battery test position simultaneously with release of mirror lock-up (see page 8).

CAUTION: Make sure that the selector lever is set at a click stop position and not in-between two settings.

VIEWFINDER

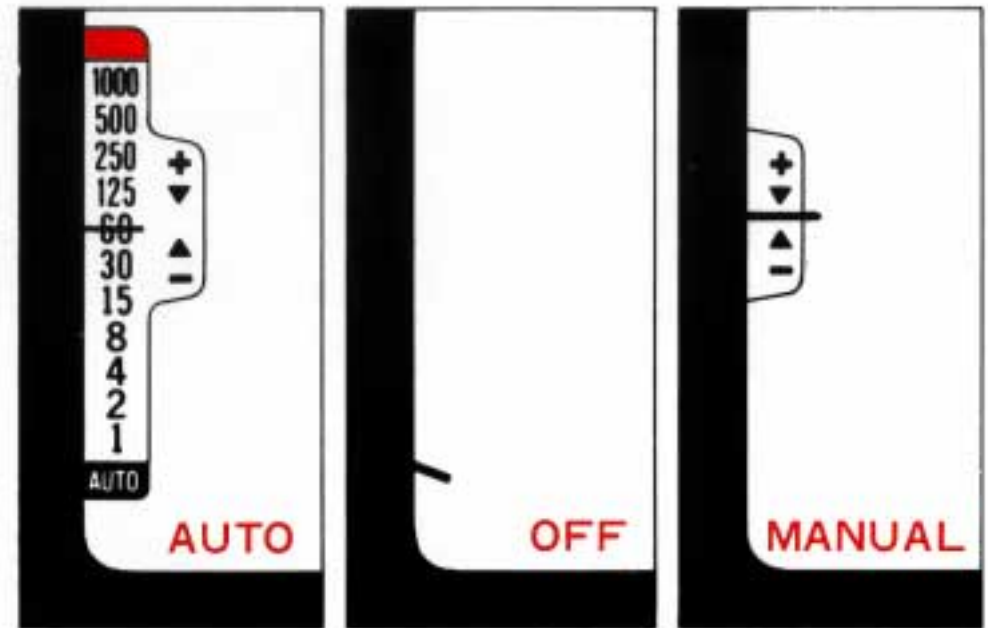

Viewfinder

The three-position viewfinder control center allows you to see the operating mode of your camera without checking the position of the selector lever.

NOTE: If you release the shutter with the selector lever at **OFF** in normal lighting condition, the built-in automatic exposure control is activated to take a properly-exposed picture, so as not to miss optimum exposure opportunity, at any moment. The difference between the automatic exposures in the **OFF** position and the **AUTO** position, however, is that the **OFF** mode exposure stops in 1/30 sec. maximum to save battery exhaustion, and the **AUTO** viewfinder scale does not appear.



▲ In focus.



▲ Out of focus.

Look through the viewfinder and turn the focusing ring in either direction until your subject appears sharpest. The split image will be vertically aligned in the central spot of the Focusing Screen or a shimmering effect of the microprism ring around the central spot will disappear when critical focusing has been achieved.

NOTE: The OM-2 viewfinder shows 97% of the actual picture area for added convenience, when composing your pictures.

You can determine the distance between the subject and the film plane by reading the distance scale on the focusing ring after you achieve critical focusing. The actual distance is indicated opposite the red central index mark on the lens mount ring; the white scale indicates this distance in meters and the orange scale indicates this distance in feet.

(For Focusing Screen replacement read pages 28 and 52).

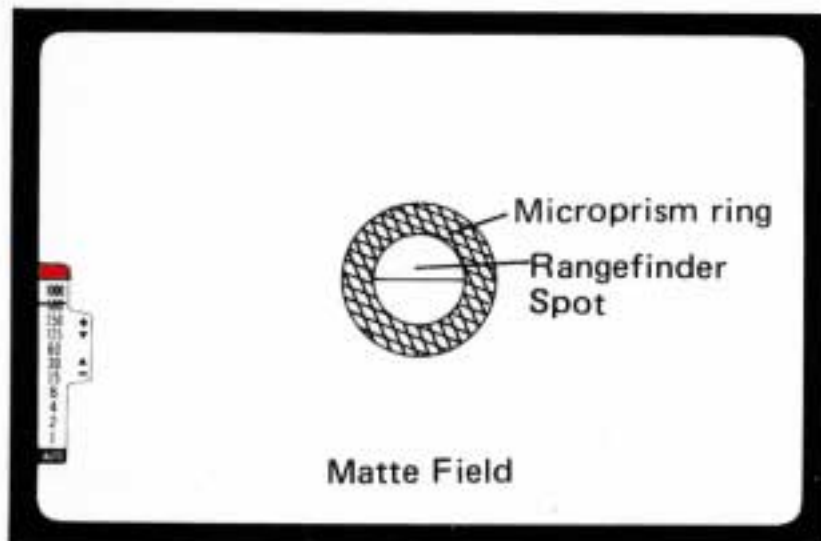

AUTOMATIC EXPOSURE CONTROL



The Aperture-Preferred System

The aperture-preferred system is the most convenient and easy-to-use method of automatic operation, particularly outdoors when using 50mm or wide-angle lenses. To use this system:

- ① Set the selector lever to the "AUTO" position making sure that the lever "clicks" into place.
- ② Set the F stop you wish to use on the lens aperture ring.

NOTE: The AUTO exposure is operative at any shutter speed except "B".

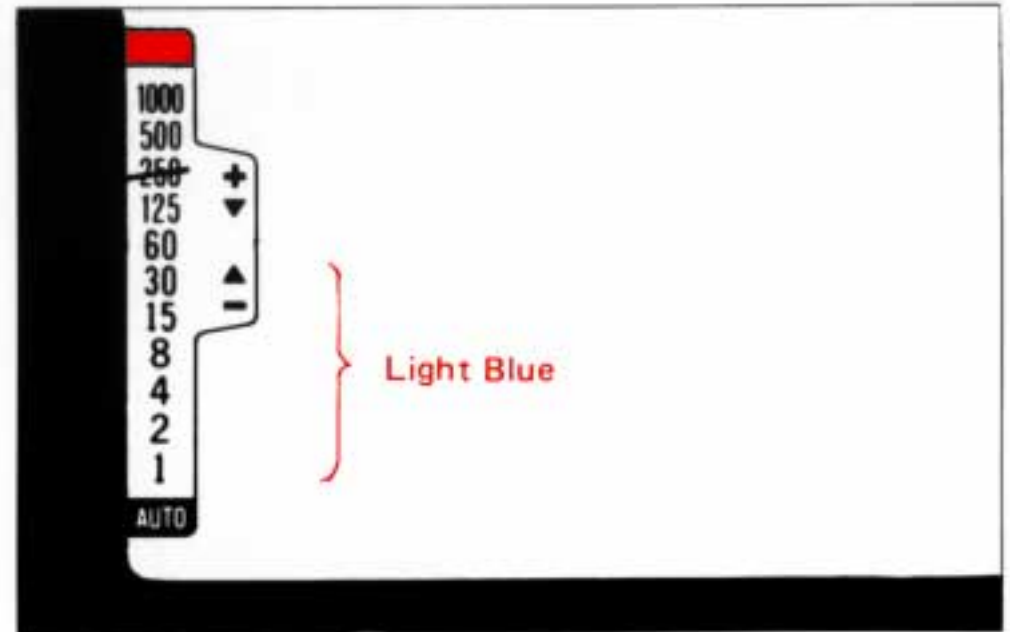

- ③ The camera will automatically determine the shutter speed required for proper exposure and indicate that speed in the viewfinder. Then **RELEASE THE SHUTTER**.

NOTE: At shutter speeds slower than 1/60 second, the possibility of camera movement during exposure is increased. If the needle in the viewfinder indicates a shutter speed in this area, turn the aperture ring to the left (so as to open the aperture).

For use of interchangeable lenses of various angles of view, refer to the data below to determine the minimum recommended hand-held shutter speed and avoid blurry pictures:

- ① Wide-angle and super wide-angle lenses – 1/30 second or faster.
- ② 50mm lenses – 1/60 second or faster.
- ③ Telephoto and Zoom lenses to 100mm – 1/125 second or faster.
- ④ Telephoto and Zoom lenses to 200mm – 1/250 second or faster.
- ⑤ Super telephoto lenses of 300mm and up – 1/500 second or faster.

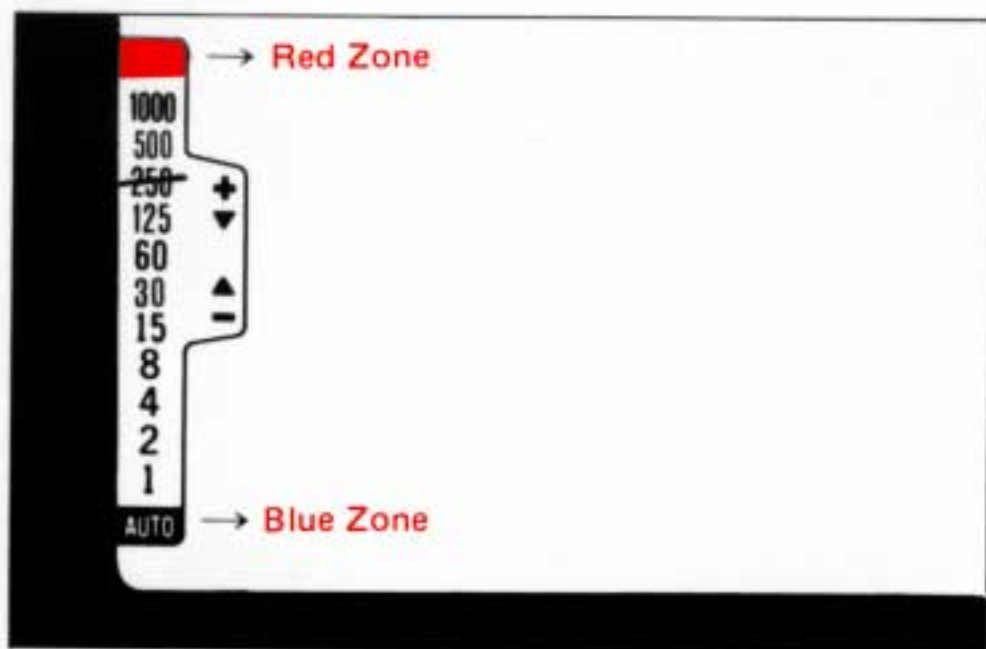

- ④ If the viewfinder needle enters the red zone → Warning against over-exposure. A shutter speed faster than 1/1000 second is required for proper exposure, but the shutter will be released at 1/1000 second. Since this is beyond the range of your OM-2 and an overexposed photograph would result, turn the lens aperture ring to a higher F stop until the meter needle moves out of the red zone.
- ⑤ If the viewfinder needle enters the blue "AUTO" zone → Indication for long time exposure. A shutter speed longer than 1 second is required for proper exposure. Your OM-2 provides for automatic exposures from 1 second to 120 seconds (with ASA 100 at normal temperature and humidity). If you wish to close the shutter during a long time exposure under AUTO operation, turn the selector lever to the OFF position, and the shutter closes.

CAUTION: Do not advance the film while the mirror is up during an automatic exposure, or the mirror will lock up.

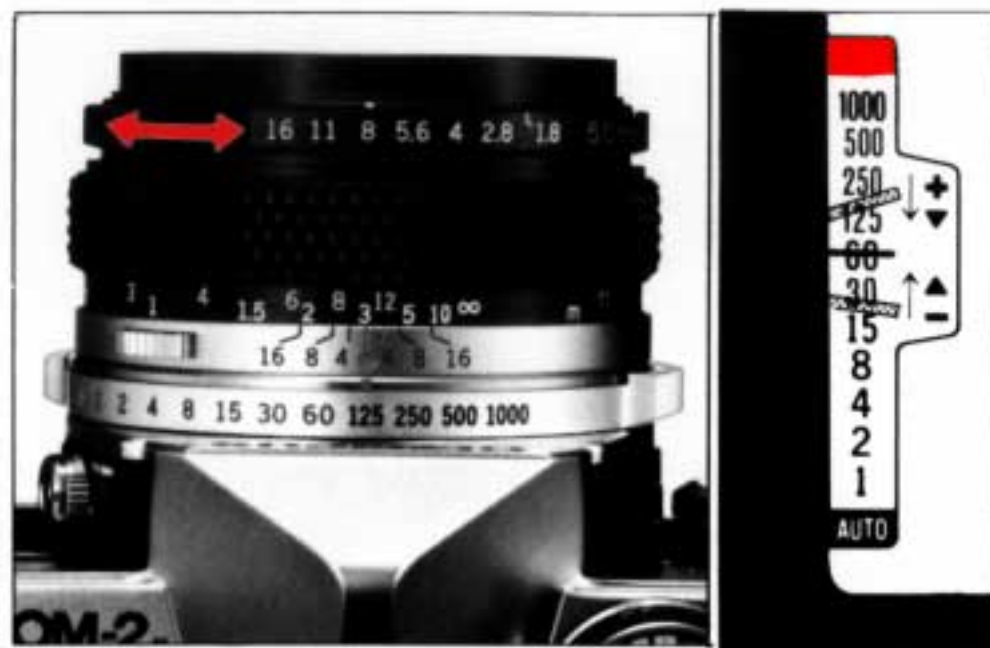

The Shutter Speed-Preferred System

Should you wish to select a shutter speed to meet a specific photographic situation (e.g., stopping fast action, eliminating camera movement or controlling depth-of-field), you may use a shutter speed-preferred method of automatic exposure control. To use this system:

- ① Set the selector lever to the "AUTO" position.
- ② Look through the viewfinder and turn the aperture ring until the viewfinder needle points at the desired shutter speed.

MANUAL EXPOSURE CONTROL



Set the selector lever to the "MANUAL" position, and the exposure index marks and the meter needle are visible in the viewfinder.

Shutter Speed-Preferred Manual Exposure Control

- ① Should you wish to preselect a shutter speed (e.g., to stop fast action, eliminate camera shake, etc.), turn the shutter speed ring until the desired speed is opposite the red reference dot on the lens barrel (see page 12).
- ② Look through the viewfinder and turn the aperture ring until the needle lines up in the center of the index. For fine exposure adjustment you can use any click-stop or intermediate F stop position.

CAUTION: In case of hand-held photography with a 50mm lens, a shutter speed 1/60 sec. or faster is recommended to eliminate the possibility of camera movement.



Aperture-preferred Manual Exposure Control

Should you wish to preselect the F stop (e.g., to control depth of field) (see page 25):

- ① Turn the aperture ring until the desired F stop is opposite the white index mark.
- ② Look through the viewfinder and rotate the shutter speed ring until the needle lines up as close as possible to the center of the index. Make sure that the shutter speed ring is clicked into position and not between two settings.
- ③ Make the final exposure adjustment by turning the aperture ring until the needle aligns exactly in the center of the index.

CAUTION: Make sure that the shutter speed thus obtained should meet the other photographic conditions properly, especially at "B" where the shutter speed ring is not coupled with the exposure meter.

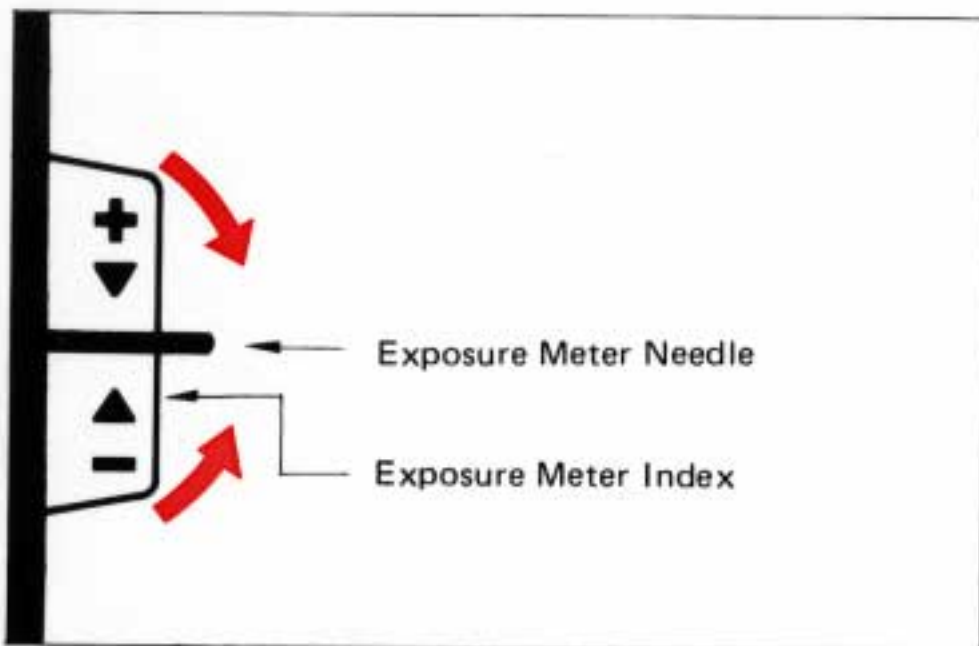

If the Exposure Needle Does Not Center on the Index

If an exposure or a shutter speed is improperly selected, the exposure needle will not center on the index. Reset the shutter speed or F stop until the needle is centered.

You may use an ND (neutral density) filter if the subject is too bright, or an electronic flash or flash bulb if the subject is too dark.

ASA 100	50mm F1.8 lens, fully opened	1/2 sec.
ASA 100	50mm F1.4 lens, fully opened	1/2 sec.
ASA 100	55mm F1.2 lens, fully opened	1/2 sec.

Light Measuring Range of the Exposure Meter

The measuring range is EV1.5–EV17 (ASA 100, with F1.2 55mm lens). The list above summarizes the lowest measurable limits in dealing with extreme low light conditions.

CAUTION: If the aperture ring or shutter speed ring is turned below the limits in the list, with extremely low lighting or the selector lever OFF, the needle sometimes moves, but the meter is not functioning.

HOLDING THE CAMERA



Proper camera handling is important in assuring the sharpest possible pictures.

Holding the Camera Horizontally

Keep both elbows close to the body, to steady the camera.

Putting the Camera into Operation

The aperture ring, focusing ring and shutter speed ring are so arranged as to enable one hand operation right up to the moment the shutter is released. Hold your breath at the moment of shutter release.

Transport the film advance lever with your right thumb and squeeze the release button smoothly using the cushion, not the tip, of your index finger.



Holding the Camera Vertically

For vertical shooting, keep one elbow close to your body and press the camera tightly against your forehead.

NOTE: Steady yourself against any nearby support (such as a tree, fence, or wall) whenever possible.

NOTE: For telephotography, or slow shutter speed photography, it is recommended that you use a tripod and hold the camera steady with your hands.



When the entire roll of film has been exposed (indicated by the numbers "12", "20", "24" or "36" on the exposure counter depending upon the film length), rewind the film.

- ① Turn the rewind release lever counter-clockwise by about 90°.
- ② Fold out the rewind crank and wind it in the direction of the arrow. While rewinding, you will feel tension on the crank. When the tension stops and the crank turns freely, the film has been completely rewound back into the cartridge.
- ③ Open the camera back by pulling up on the rewind knob and remove the film cartridge. Keep camera and film out of direct sunlight while unloading.

NOTE: The rewind release lever will automatically return to the original position with movement of the film advance lever, as when reloading with film.

Should you wish to make more than one exposure on the same frame:

- ① Take up any slack in the film by slowly turning the rewind crank in a clockwise direction until it stops, then take the first exposure.
- ② Turn the rewind release lever counter-clockwise by about 90°.
- ③ Hold both the rewind knob and rewind release lever to prevent them from turning and advance the film advance lever. The shutter will then be cocked for the next exposure without advancing the film.
- ④ Press the shutter release button with a slow, steady squeeze.
- ⑤ The exposure counter will advance with each exposure.
- ⑥ After completing the multiple exposures, put the lens cap on the lens, advance the film, and shoot a blank frame to avoid overlapping.

NOTE: You can make as many multiple exposures as you like by repeating the above procedure. With each exposure on the same frame, the possibility of slippage is increased.

SETTING THE SELF-TIMER

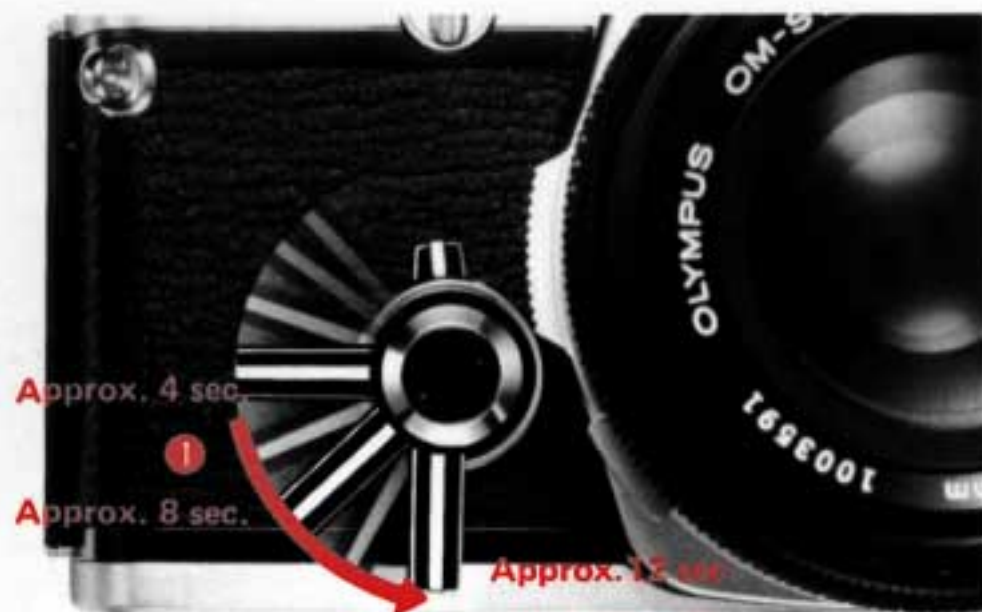

This self-timer allows you to adjust its working time from 4 sec. to 12 sec. as desired, or to stop its action during operation with ease. To set the self-timer:

- ① Rotate the self-timer lever counter-clockwise so that the shutter can be released after an elapse of delay time between 4 sec. to 12 sec. according to the lever setting as shown above. You may set the self-timer lever either before or after advancing the film.
- ② Turn the start lever clockwise to the vertical position to activate the self-timer lever. The shutter will then be released after the preset time.



Stopping the Self-timer

To stop the self-timer during its operation, turn the start lever counter-clockwise. If you turn the start lever clockwise again, the self-timer can resume its action.

CAUTION: Even after setting the lever, you can release the shutter by pressing the shutter release button.

NOTE: If you do not reset the self-timer, the timer lever will begin moving immediately after advancing the film and the shutter will be released earlier than expected. If the film has not been advanced fully, the timer lever will stop halfway. To re-activate the timer, move the start lever counter-clockwise to stop the timer lever, return the timer lever to the starting position, and advance the film. Then, turn the start lever again.

EXPOSURE COMPENSATION

OLYMPUS
OM-2



▲ After compensation



Before compensation ▶



▲ After compensation



Before compensation ▶

When the most important area of the picture is much darker than the general picture area (blue sky, beach or white wall in the sun, snowfield, etc.), the meter will have a tendency to read the brightest part of the picture leaving the main subject under-exposed. Alternatively, when taking a picture of a bright subject against a dark background (spot-

lighting, deep shadow areas, etc.), the meter has a tendency to read the darkest part of the picture leaving the main subject over-exposed. In these situations, proper exposure compensation helps you take fine pictures.

NOTE: With backlighting or sidelighting, it's always a good idea to use a lens hood to eliminate unwanted glare.

EXPOSURE COMPENSATION FOR AUTOMATIC MEASUREMENT

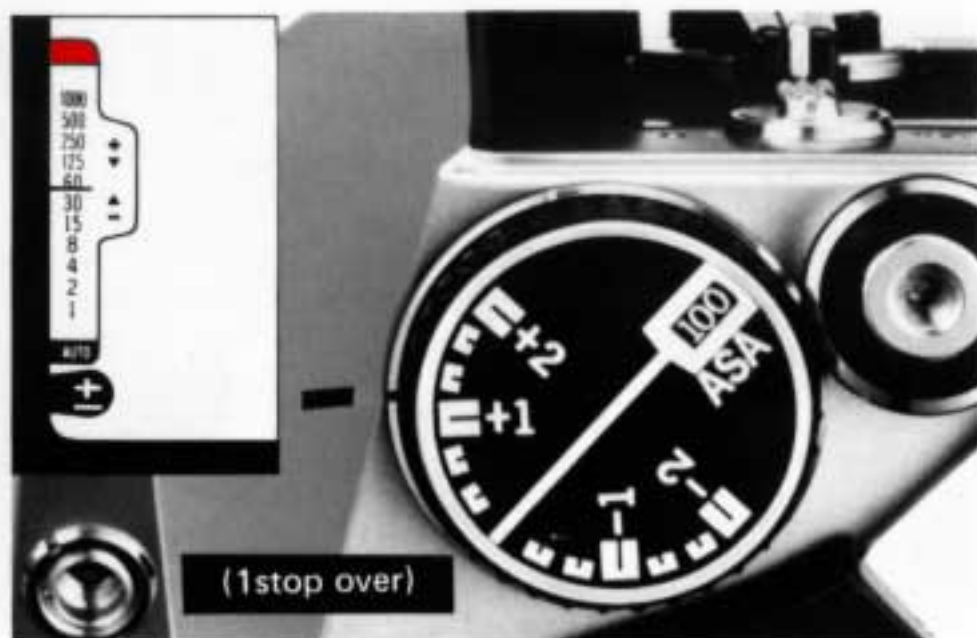

If you wish to change the exposure setting automatically selected by the camera, use the exposure compensation dial at click stop settings and a compensation marker appears in the left lower corner of the viewfinder.

NOTE: The markings 1 and 2 represent 1 and 2 full F stops of over- or under-exposure. Over- and under-exposure compensations may be necessary in the following situations:

When the main subject is much darker than the general background or when strong light strikes the subject from behind or from the side, turn the dial **to the plus (+) side**.

Turn the camera to the subject so that the subject fills most of the viewfinder picture area with minimum background, or move the camera toward the subject. After reading the shutter speed, return to the original shooting position and rotate the exposure compensation dial until the meter needle points at the desired in the finder.

NOTE: In such a case an excellent result can be obtained by turning the compensation dial to the + 1 side.

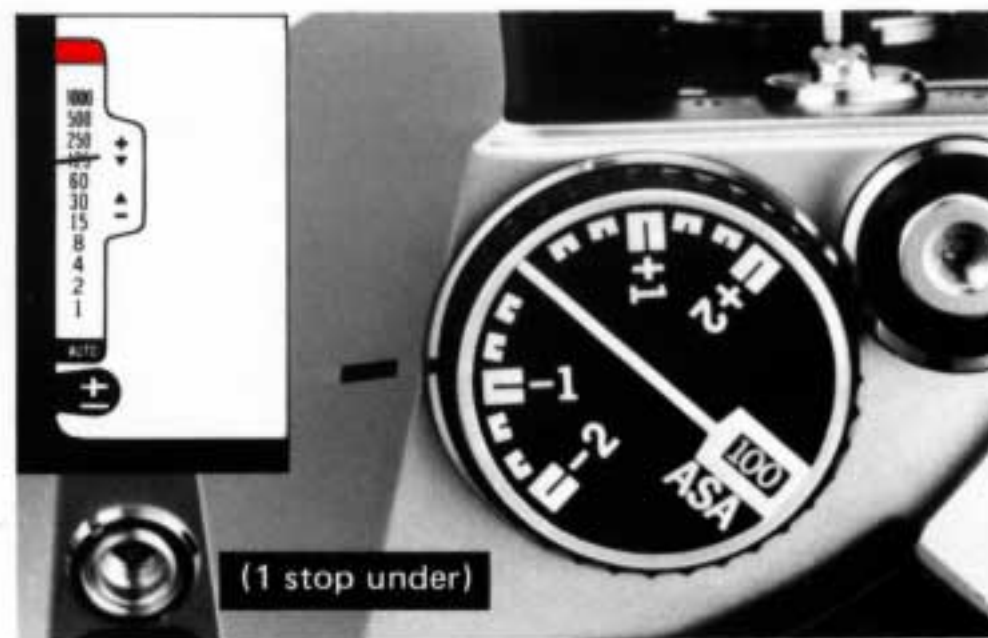

When taking a picture of a bright subject against a dark background (spotlighting, deep shadows, etc.), turn the compensation dial **to the minus (-) side**. Move forward until the subject fills as much of the viewfinder picture area as possible, (with a zoom lens, you may be able to do this by zooming in on the subject without changing your positions). After noting the shutter speed indicated by the meter needle, return to your original position, recompose the picture, and turn the exposure compensation dial until the shutter speed needle indicates the speed obtained from your close-up meter reading.

NOTE: Use the exposure compensation dial to intentionally over- or under-expose for unusual lighting conditions or effects.

CAUTION: After taking a picture using the compensation dial, be sure to return the dial to the normal setting by aligning the bold white line with the black index mark.

EXPOSURE COMPENSATION FOR MANUAL MEASUREMENT

OLYMPUS
OM-2



1 Stop Over



1/2 Stop Over



Correct Exposure



1/2 Stop Under

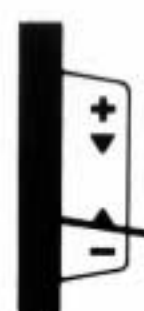

1 Stop Under

Manual exposure can be compensated by adjusting the F stop or shutter speed. The exposure needle indicates over-exposure at the (+) side, or under-exposure at the (-) side.

Dark subject in bright backlighting

When the most important area of the picture is much darker than the general picture area (strong light hitting the main subject from behind or from the side) the meter will have a tendency to read the brightest part of the picture leaving the main subject under-exposed. To compensate for this, move forward until the subject fills most of the viewfinder picture area and set the F stop/shutter speed combination which centers the meter needle between the index marks. Return to your original position and take the picture without changing this F stop/shutter speed combination even though the needle is not centered.

NOTE: Over-exposure by + 1 stop renders a good result in such a case.

Bright subject in dark background

As previously mentioned, fill the viewfinder picture area with the subject as much as possible, and set correct light measurement. Return to your original position and expose for fine pictures.

DEPTH OF FIELD



Depth of field is the area of acceptable sharpness in front of and behind the subject in focus. As you get closer to your subject or as you open your lens (e.g. from F16 to F2.8) the depth of field becomes shallower. By stopping your lens down (e.g. from F2.8 to F16) or getting farther away from your subject this depth of field can be increased.

The table at right shows that when the camera-to-subject distance is 3m, the depth of field at F16 ranges from 1.93m to 6.93m.

As you press the preview button, looking through the viewfinder, you can ascertain the actual depth of field.

NOTE: The depth-of-field tables (indicated in meters and feet) are printed on the instruction leaflet supplied with each lens.

Depth of Field Table (F1.8 & F1.4 50mm Lenses) Circle of least confusion 1/30mm

Scale F Stop	Camera-to-Subject Distance (m). Figures with * are engraved on the distance scale.									
	*0.45	*0.5	*0.7	*1	*1.5	*2	*3	*5	*10	*∞
1.4	0.45 ~0.45	0.50 ~0.50	0.69 ~0.71	0.99 ~1.02	1.47 ~1.54	1.94 ~2.07	2.85 ~3.16	4.61 ~5.46	8.55 12.05	57.78 ~∞
1.8	0.45 ~0.45	0.50 ~0.50	0.69 ~0.71	0.98 ~1.02	1.46 ~1.55	1.92 ~2.09	2.8 ~3.20	4.52 ~5.60	8.21 12.79	45.05 ~∞
2	0.45 ~0.45	0.50 ~0.50	0.69 ~0.71	0.98 ~1.02	1.45 ~1.55	1.91 ~2.10	2.80 ~3.23	4.47 ~5.68	8.05 13.20	40.57 ~∞
2.8	0.45 ~0.45	0.49 ~0.51	0.69 ~0.71	0.97 ~1.03	1.48 ~1.57	1.88 ~2.14	2.73 ~3.33	4.28 ~6.01	7.47 15.15	29.02 ~∞
4	0.44 ~0.46	0.49 ~0.51	0.68 ~0.72	0.96 ~1.04	1.41 ~1.61	1.83 ~2.20	2.63 ~3.49	4.04 ~6.57	6.74 19.44	20.35 ~∞
5.6	0.44 ~0.46	0.49 ~0.51	0.67 ~0.73	0.94 ~1.06	1.37 ~1.66	1.77 ~2.29	2.5 ~3.74	3.75 ~7.52	5.96 31.31	14.55 ~∞
8	0.44 ~0.46	0.48 ~0.52	0.66 ~0.74	0.92 ~1.09	1.32 ~1.73	1.69 ~2.45	2.34 ~4.18	3.39 ~9.61	5.09 378.10	10.21 ~∞
11	0.43 ~0.47	0.48 ~0.53	0.65 ~0.76	0.90 ~1.13	1.27 ~1.84	1.60 ~2.68	2.17 ~4.91	3.02 14.74	4.30 ~∞	7.44 ~∞
16	0.43 ~0.48	0.47 ~0.54	0.63 ~0.79	0.86 ~1.20	1.19 ~2.05	1.47 ~3.17	1.93 ~6.93	2.57 138.43	3.42 ~∞	5.13 ~∞

DEPTH OF FIELD SCALE

PREVIEW BUTTON



The double series of numbers engraved on the depth of field scale represents F stops: F4, F8, and F16. Once you have focused on your subject, all objects within the distance range indicated on the lens distance scale between the marks for the F stop you have selected will have acceptable sharpness. For example, in the above picture, the camera-to-subject distance is 3m (10ft.) and the lens is set at F16. If you read the distance scale at the points opposite the engraved "16" on both sides of the reference dot, you will find that the depth of field is from 1.9m (6ft.) to 7m (23ft.).



When you wish to see which objects fall within the acceptable zone of sharpness (depth of field), press the preview button on your lens. The diaphragm of the lens will stop down to the preset F stop enabling you to see the depth of field in the viewfinder.

CAUTION: If you jerk the preview button while depressing the shutter release button halfway down, the shutter might be released.

INFRARED PHOTOGRAPHY

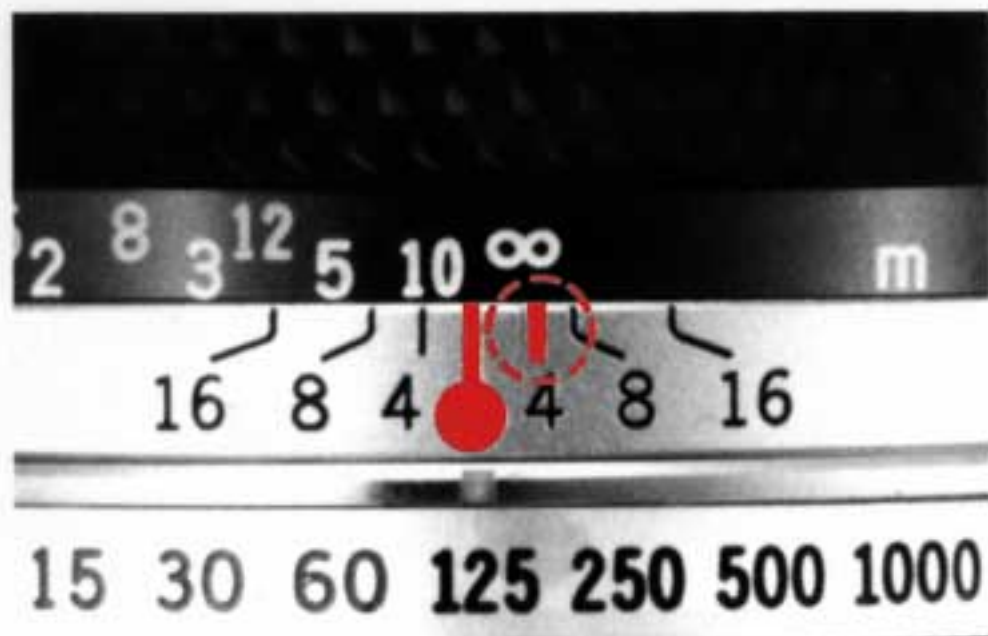

The OLYMPUS OM System Lenses are provided with an infrared index mark engraved in red on the depth of field scale to the right of the reference dot.

When shooting with infrared film, focus normally on your subject without the red filter on and read the subject distance on the distance scales. Then, turn the focusing ring to the right until the distance reading is opposite the infrared index mark. Your lens will then be in focus for average infrared photography. Shoot with the red filter on. In the above picture, the red index is set at infinity.

CAUTION: Due to special light gathering requirements of infrared films, it is recommended that you follow the film manufacturer's recommendations regarding exposure.

CAMERA BACK REPLACEMENT



The camera back of the OM-2 is fully interchangeable with the Recordata Back 2 and 250 Film Back 1. To remove the camera back, push down on the release pin as shown. Do not remove the back unless necessary.

The Recordata Back 2 registers data such as date, number, alphabetical code, etc. directly on the picture.

The 250 Film Back 1 is designed for winder or motor drive shooting; it accepts a bulk loaded magazine of 250 frames.

INTERCHANGEABLE FOCUSING SCREENS

OLYMPUS
OM-2

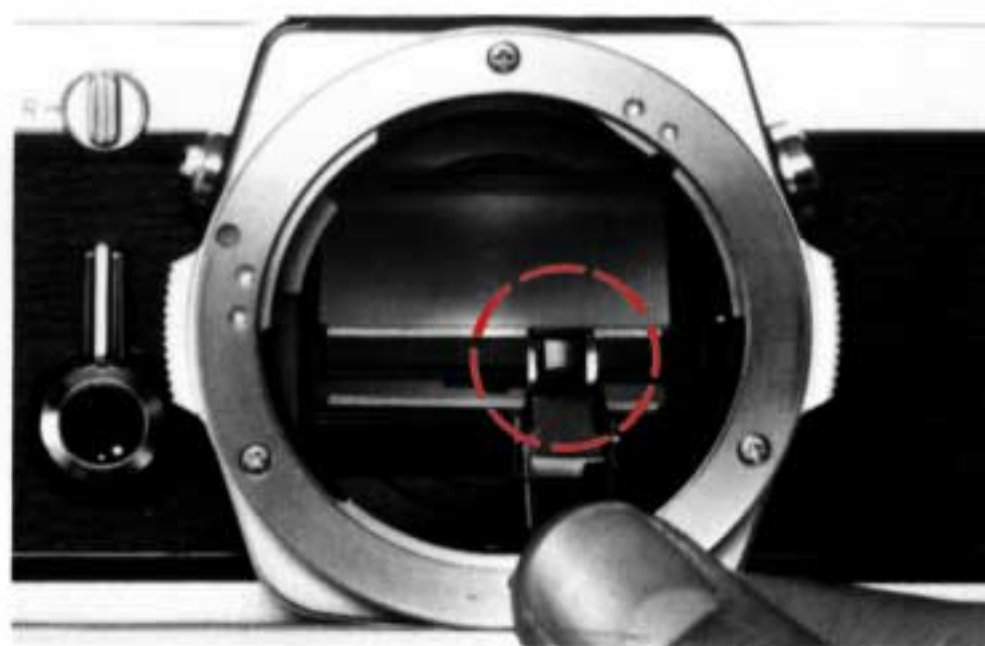
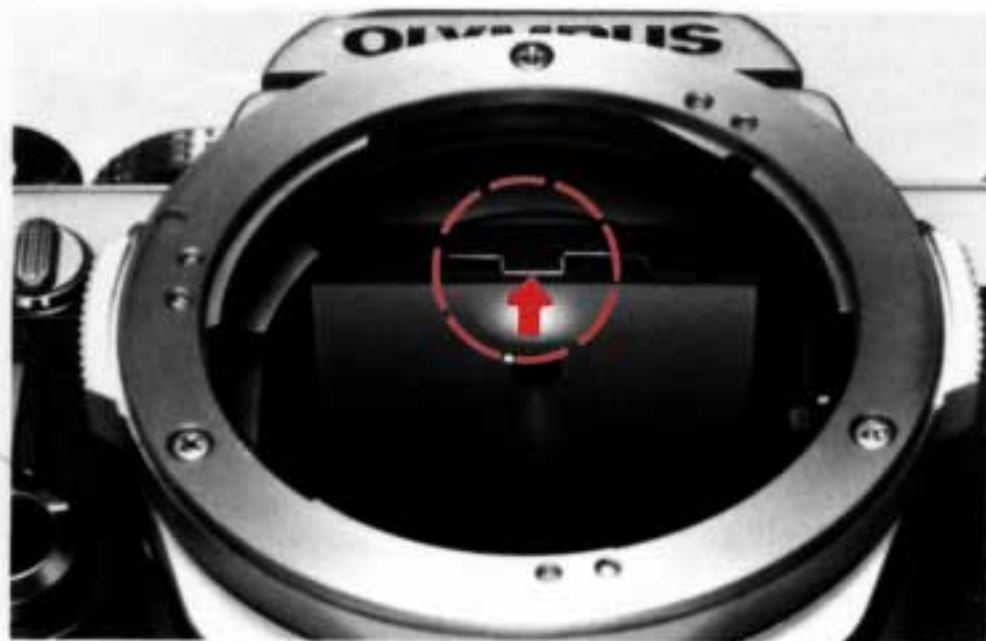

The OM System interchangeable focusing screens provide you with the ultimate in focusing versatility. Optional screens are available to suit virtually every picture-taking situation. The focusing screens come with a special tool. To remove the focusing screen:

- a) Detach the camera lens from the camera body.
- b) Use the special tool provided to push up on the release catch underneath the top ledge of the mirror box (see the photo above). This allows the screen and screen frame to drop down.
- c) Remove the screen from inside the camera by gripping the tip of the screen with the tool as shown.
- d) To install the screen, fit it into the frame and push the frame upward gently until it clicks into place. Gently shake the camera body to make sure the screen is held securely in place.

CAUTION: Although the above procedure can be done with fingers, it is recommended that you use the special tool supplied. Changing focusing screens is a procedure to be exercised with great care. Trying to change a screen with your fingers can result in fingerprints and costly damage to the surface of the screen, the prism, or the mirror. Should this occur, cleaning or repair **MUST** be handled by an authorized service center. Such damage is not covered by the product warranty.

FLASH PHOTOGRAPHY WITH THE T20 ELECTRONIC FLASH

Electronic Flash T20



TTL Centralized Control Flash

The T20 is the world's first fully automatic electronic flash unit. All its functions are controlled directly by the OM-2 to produce extremely easy, yet highly accurate flash exposures.



- ① Attach the Accessory Shoe 4 to the OM-2 and mount the T20.
- ② Set the camera's selector lever to the "AUTO" position and switch on the T20.

NOTE: Mounting the T20 on the accessory shoe automatically completes the "X" synchro circuit. It is not necessary to set the X and FP flash selector to "X".

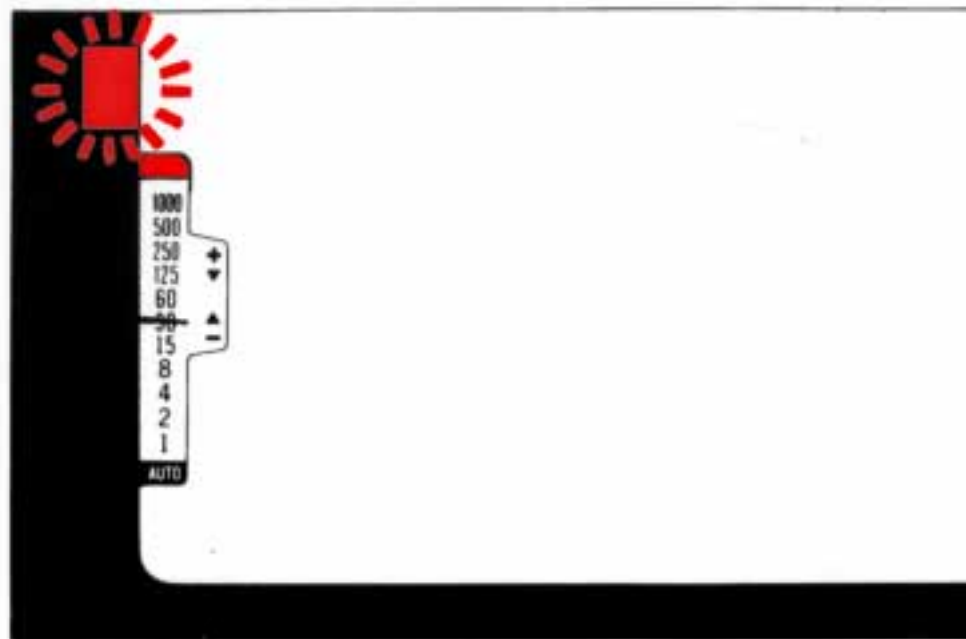

- ③ A red lamp lights in the viewfinder when the T20 capacitor is charged and ready for shooting.
Set the aperture ring to the f/stop you require, focus on the subject and release the shutter.

NOTE: All f/stops on the camera lens can be used.

FLASH PHOTOGRAPHY WITH THE T20 ELECTRONIC FLASH

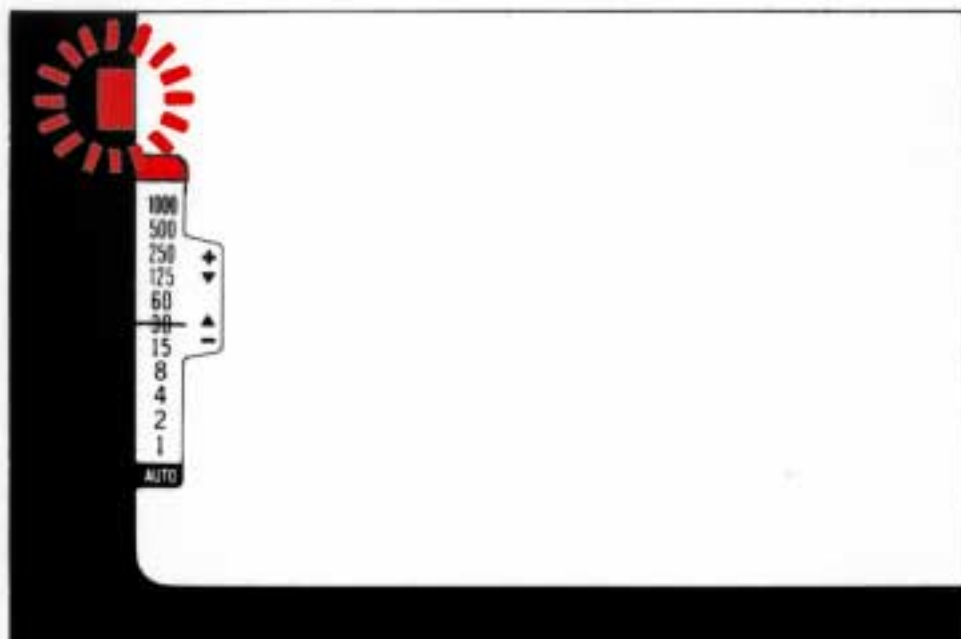

- ④ After shooting, the red lamp blinks to indicate that correct flash-exposure has been made.
- If the lamp stays lighted:
→ Correct exposure has been made requiring no flash.
 - If the lamp does not flicker, but instead goes out:
→ The flash-to-subject distance is beyond the TTL AUTO range. Open up the lens stop or move in closer to the subject.

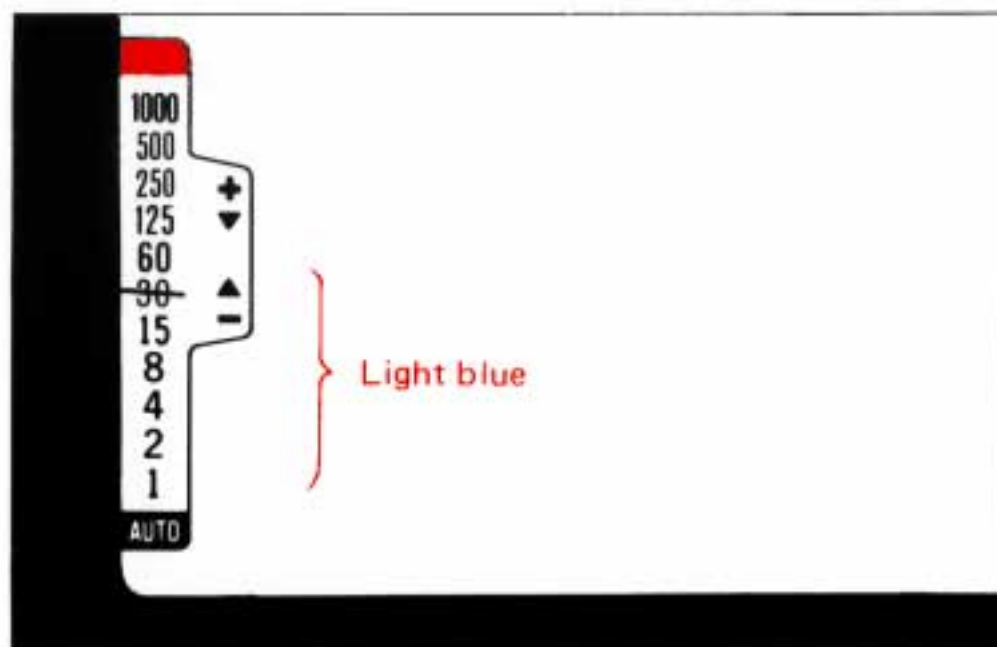

When exposure must be achieved with flash

Focus on the subject and make sure the meter needle points to a shutter speed 1/30 sec. or slower. If the shutter speed is faster than 1/30 sec., turn the aperture ring to a larger f-number (a smaller lens opening).

NOTE: The OM-2 incorporates an "incorrect flash prevention" system. If the shutter speed is faster than the flash synchronizing range, the electronic flash will not fire when you press the shutter release button.

→ See P. 55 for further information on the T20.

THE T20/OM-2 WAY—FLASH PHOTOGRAPHY COULDN'T BE SIMPLER AND MORE ACCURATE

OLYMPUS
OM-2

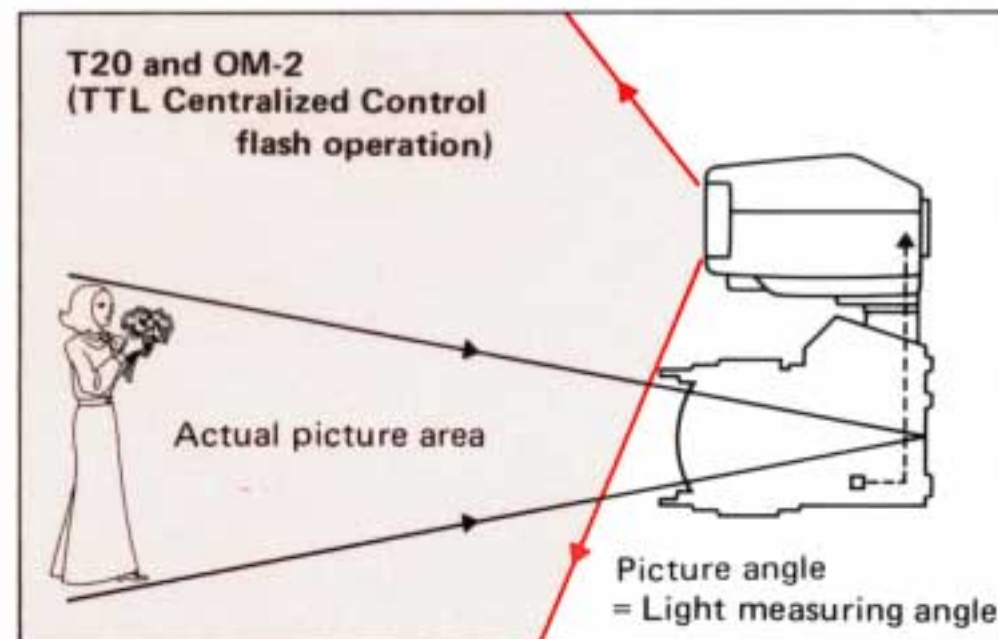
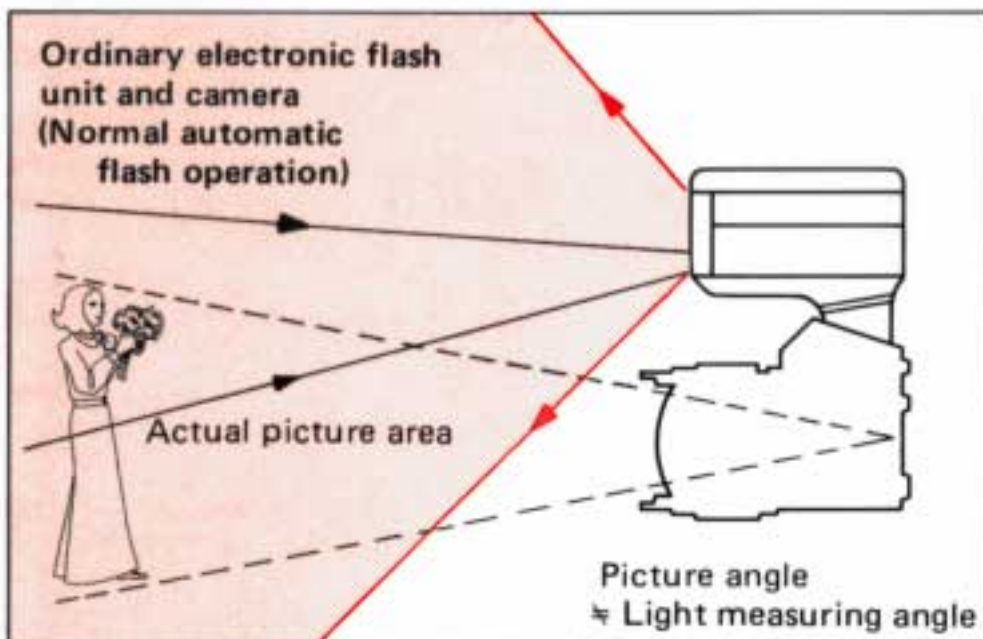

All required of the T20 is a flick of the on/off switch. The rest is taken care of by the OM-2.

- The dial settings required of conventional "auto" flash units — ASA film speed setting, aperture setting and "X" setting — are not needed with the T20.

- Unlike conventional auto flash units which regulate flash emission by an independent light sensor, the T20 utilizes the OM-2's own built-in SBC light sensors, so that the flash acceptance angle always coincides with the picture angle of the camera lens.

- The OM-2 shutter automatically closes at the instant the flash exposure has been completed, eliminating camera shake.

- By the incorporation of an incorrect flash prevention system, the electronic flash will not fire if the shutter speed is faster than the synchronizing range.

- Special techniques such as diffused lighting are made easy, obviating complicated compensations and guesswork.

- Usable flash-to-subject distance range is greatly expanded — from 25cm (F16) to 16m (F1.2) with a guide number of 20 (ASA 100, meters).

FLASH PHOTOGRAPHY WITH AN ELECTRONIC FLASH UNIT OTHER THAN THE T20

FLASHBULB PHOTOGRAPHY

- ① Attach the Accessory Shoe 4 to the OM-2.
- ② Mount the electronic flash on the accessory shoe.
If your electronic flash unit does not have a direct contact "hot shoe", connect its synchronizing cable to the camera flash socket.
- ③ Set the synchro terminal to "X" by aligning the red dot on the FP and X selector with the "X" indication on the flash socket.

NOTE: Mounting the electronic flash unit on the accessory shoe automatically completes the "X" synchro circuit. However, there are some brands which do not fire unless the selector is set to "X".

- ④ Move the selector lever to the "MANUAL" position.
- ⑤ Set the ASA film speed on the flash unit.
- ⑥ Set the shutter speed ring to 1/30 sec.
- ⑦ Set the flash unit to the automatic or manual setting.
- ⑧ Set the desired F stop on the flash unit (in the case of auto mode), and then set the aperture ring to this F stop. In the case of manual mode, determine the correct F stop by using the calculator dial or exposure table provided with your flash unit. You may also determine the correct F stop by using the following formula:

$$F \text{ stop} = \frac{\text{flash guide number}}{\text{flash-to-subject distance}}$$

NOTE: With the Quick Auto 310 and OM-2_N combination, the TTL Centralized control flash cannot be achieved. Use them in the normal auto/manual operation.

- ① Plug the synchronizing cable leading from the flash unit into the camera flash socket, and then attach the flash unit to the camera.
- ② Select the proper synchro setting from the table below according to the type of bulb being used, and align the red dot on the X and FP flash selector with the "X" or "FP" indication alongside the flash socket.

CAUTION: With the clip-on type "FP" class flash unit, the synchronizing cable must be used to connect the unit and the camera.

- ③ Select the proper shutter speed from the table below, and set the shutter speed ring accordingly.
- ④ Determine the correct F stop for flash exposure by using the calculator dial, exposure chart or guide number formula. Set the aperture ring to this F stop.

■ The table indicates proper synchronization speeds for most flash equipment.

Terminal	Flash Lamp	Shutter Speed										
		1000	500	250	125	60	30	15	8	4	2	1
FP	FP	○	○	○	○	○	*	*	*	*	*	*
X	Electronic Flash					○	○	○	○	○	○	○
	MF						*	○	○	○	○	○
	M · FP							○	○	○	○	○

○ = Recommended; * = Not recommended due to bulb quality.



Featuring an amazingly compact and lightweight design tailored perfectly to match the OM camera body, the Olympus motor drive package easily follows swiftly moving subjects with which larger-format cameras can't keep pace.

Motor Drive 1

The standard motor drive unit forms the heart of the Motor Drive Group. An extremely high-performance unit capable of high-speed sequence shooting at 5 frames per second, operating off various power units. Can be switched to the "single" mode of operation, winding film at a high speed of 0.16 second per frame.



Winder 1

The Winder 1, designed for single-frame shooting, operates on four self-contained AA batteries and is extremely compact and light. The unit advances the film and cocks the shutter as soon as exposure is made (operational time 0.3 sec.), so that the photographer can always be ready to freeze the subject at the right moment.

MOTOR DRIVE PHOTOGRAPHY



Motor Drive 1



M.18 Control Grip 1



■ Attaching the Motor Drive 1

- ① Remove the motor drive socket cap from the camera base plate by rotating it counter-clockwise with a coin until the index dot on the cap is aligned with the index dot on the camera. To replace the cap, align the index dot on the cap with the index dot on the camera, and turn the cap clockwise with a coin until the index dot on the camera is aligned with the groove on the cap.
- ② Insert the motor drive guide pin into the guide pin hole on the camera base plate. To assure proper connection, adjust the position of the Motor Drive 1 until it is flush with the camera. Turn the clamping screw clockwise until the Motor Drive 1 is securely attached to the camera base plate.



■ Attaching the M.18V Control Grip 1

- ① Remove the M.18V Battery Holder 1, insert twelve 1.5V penlight (AA) size batteries into the battery holder, and re-insert the battery holder into the Control Grip.
- ② Align the red index line on the rear of the control grip with the red index line on the rear frame of the motor drive unit until the mounting catch is engaged. Carefully push the control grip forward until it snaps into the front of the motor drive.

NOTE: A flat-type rechargeable power source, the M. 15V Ni-Cd Control Pack 1, is also available. For details of motor drive units, refer to page 59.



■ Photography with the Motor Drive Units Using the M.18V Control Grip 1

- ① Unlock the shutter release lock lever on the Control Grip by moving it forward and upward.
- ② Turn the mode selector on the Control Grip to either "SINGLE" or "SEQUENCE". Set the mode selector to the "OFF" position when the Motor Drive 1 is not in use.

NOTE: In either mode, automatic exposure control is possible in the full range of shutter speeds, and manual exposure is possible from 1 second to 1/1000 second.

- ③ Release the shutter.

NOTE: You may use either the shutter release on the Control Grip 1 or the shutter release on the Motor Drive 1 to trigger the shutter.

WINDER 1 OPERATION



Attaching the Winder 1

- ① Remove the motor drive socket cap.
- ② Pull up and rotate the switch dial to the "OFF" position.
- ③ Remove the M.6V Battery Holder 1 from inside the winder, insert four 1.5V penlight (AA) size batteries into the battery holder, and put it back into the compartment. Insert the guide pin into the guide pin hole on the camera base plate. Turn the clamping screw clockwise until the Winder 1 is securely attached to the camera base plate.

Taking the pictures

- ① Pull up and rotate the switch dial to the "SINGLE" position.
- ② Press the shutter release.

NOTE: The removed motor drive cap can be stored in the socket cap storage positioned on the underside of the battery holder compartment.

General

- Dust and moisture are harmful agents affecting your camera. Remove the camera from the case and store it in a dry, well-ventilated place making sure the shutter and self-timer are free from tension. Do not store the camera near moth balls or similar volatile chemical materials to avoid the possibility of damage to metal surfaces.
- When storing the camera for a long period of time, remove the battery. Wipe battery surfaces with a dry cotton cloth before re-inserting into the camera.
- Avoid dropping or hitting the camera.
- Never store the camera where temperatures exceed 50°C (122°F). When you use the camera in temperatures under -20°C (-4°F), it may sometimes fail to operate properly. To avoid this, warm the camera before use. Protect against excess moisture by using packs of silica gel or other desiccant in the storage area.
- After use near the ocean, wipe the camera surfaces clean with a soft cloth; never leave salt on the camera. (Salt may be airborne near the ocean and collect on the camera even though it has not been in direct contact with water.)
- Avoid excessive tightening when mounting on a tripod.
- Never expose the camera to direct sunlight. Avoid areas exposed to corrosive chemicals, radios, TV sets, or magnets.
- Have all repairs performed by an authorized OLYMPUS Service Center. You may send it through the store where you bought your camera or directly to an Olympus Service Center.

Parts

- Do not press the shutter release button at random.
- Do not touch any part that moves at high speed such as the shutter, instant return mirror, diaphragm, etc.
- Avoid touching the surfaces of the lens. Clean only with an air blower, antistatic brush, or wipe it lightly with a camel hair brush or lens tissue. In EXTREME cases, use a clean, soft cotton cloth moistened with denatured alcohol. NEVER rub the lens surfaces with your finger, clothing, or other abrasive material.
- If dust or fingerprints collect on the mirror, focusing screen, or prism, take the camera to an authorized OLYMPUS Service Center. It needs professional attention.

QUESTIONS & ANSWERS

Q: My camera is loaded with film. Why doesn't the rewind knob rotate when I advance the film?

A: The film leader may not be inserted in the film take-up spool and the film is not advancing. (See page 9.)

Q: Why can't I advance the film?

A: The shutter may be cocked and ready to fire. Try pressing the shutter release button. (See page 10.)

Or, the film may be fully exposed. Check the exposure counter. If you feel tension on the film advance lever, **DO NOT FORCE IT**. Rewind the film. (See page 20.) Or the self-timer lever is not securely in its upright position, reset and release the self-timer. (See page 21.)

Q: Why won't the shutter release button move when I press it?

A: The film advance lever may not have been fully advanced. (See page 9.)

Q: I can't advance the film nor release the shutter, and the viewfinder is totally dark. Why?

A: The mirror is locked up because the batteries are depleted or the film was advanced in the middle of an automatic exposure. Press the selector lever to the "CHECK-RESET" position to unlock the mirror. (See page 8.) Two batteries should be replaced as a pair if they are depleted.

Q: Why won't the rewind crank turn when I try to rewind the film?

A: The rewind release lever may not be rotated in the arrow direction until it aligns with the "OM-2" marking. (See page 20.)

Q: Why can't I set the ASA film speed I need?

A: At the most, 3 stops can be advanced in a single stroke of the dial. If you require more stops, lift up and rotate the outer collar of the dial until it stops; then release the collar and reverse the collar and dial

together until the white line is aligned with the black index on the pentaprism. Repeat this procedure until you reach the ASA speed you need. (See page 11.)

Q: What batteries should I use?

A: Use two 1.5V silver oxide batteries (Eveready or UCAR S-76, EPX-76 or equivalents). Never use 1.3V mercury batteries (though they are the same size). (See page 7.)

Q: Why doesn't the battery chamber cap fit?

A: If you also own an OM-1, you may have the caps mixed up. Although they look alike, the OM-2 cap has a "2" engraved inside.

Q: When should I check the batteries?

A: (1) When new batteries are inserted. (2) After the camera hasn't been used for a long time. (3) Before beginning a prolonged period of use.

Q: Can film be properly exposed when the selector lever is in the "OFF" position?

A: The OM-2 is designed to always expose the film 1/30 second or faster (ASA 100) with the selector lever at the OFF position. If the shutter is unintentionally released in darker condition on "OFF" mode, the exposure automatically stops in approx. 1/30 second (ASA 100) to save unnecessary battery exhaustion.

Q: Can I set the shutter speed ring to any position to take pictures on AUTO mode?

A: Any position except "B".

Q: Why is the automatic exposure shutter speed much longer than indicated by the meter in the viewfinder?

A: If film is not loaded, the shutter speed is much longer than that indicated. If it is necessary to obtain a correct reading without actually taking a picture, insert a waste, undeveloped film or the paper you find behind the camera back at the purchase of your OM-2, into the film position in the camera.

Q: Can I use the exposure compensation dial when the selector lever is set at the "MANUAL" position?

A: Yes. If the exposure compensation dial is set for an intentional over- or under-exposure, that over- or under-exposure will be achieved when the shutter speed/F stop combination centers the meter needle between the over- and under-exposure index marks in the viewfinder. (See page 24.)

Q: How can I remove dust from inside the viewfinder?

A: After detaching the Focusing Screen, blow away any dust with an air blower. Never wipe the screen surface with cloth or paper. (See page 28.) If this does not solve the problem, send your camera to an authorized OLYMPUS Service Center.

Q: Is it normal for the microprism in the center of the viewfinder to "shimmer" and darken?

A: Yes, when a lens with a maximum aperture smaller than F5.6 is mounted on the camera. It also happens with other lenses when the depth of field preview button is pressed.

Q: Why does the self-timer stop halfway without releasing the shutter?

A: The lever will stop without releasing the shutter if the film has not been fully advanced. Reset the self-timer and make sure the film is fully advanced. The self-timer lever moves freely because you forget to turn the

start lever after you set the self-timer lever. (See page 21.)

Q: Can I operate the camera without the motor drive socket cap in place?

A: No. Light will enter the camera body through this hole, fogging the film. Also, dust and dirt may enter, causing a camera malfunction.

Q: Why doesn't my electronic flash unit fire when I release the shutter?

A: If the shutter speed is 1/125 second or faster in conjunction with the electronic flash T20, the built-in incorrect flash prevention system does not permit flashing. Confirm the shutter speed. (see page 31.)

Q: Why do I feel a small electrical shock when I touch the terminal contact of the accessory shoe?

A: This is normal when using a side-mounting type flash. When using flash that is not connected to the accessory shoe, remove or cover the shoe.

THE MOST IMPORTANT FEATURE OF THE OM-2 — TTL DIRECT (OFF-

▼ Diagram of light path in conventional SLRs

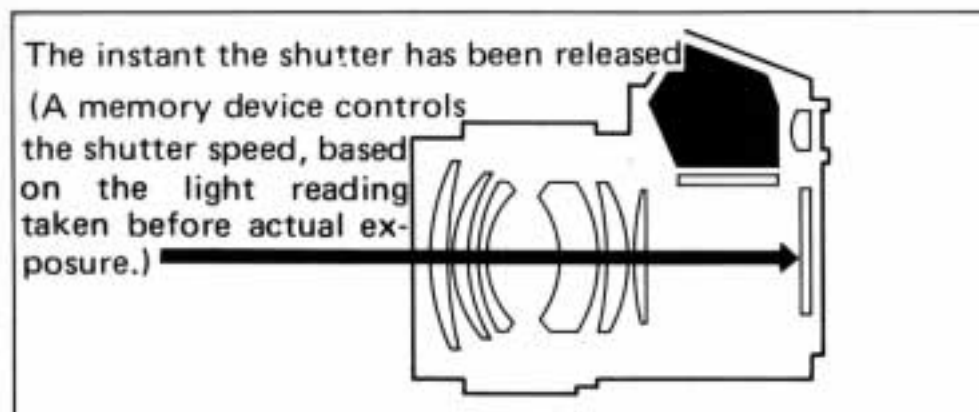
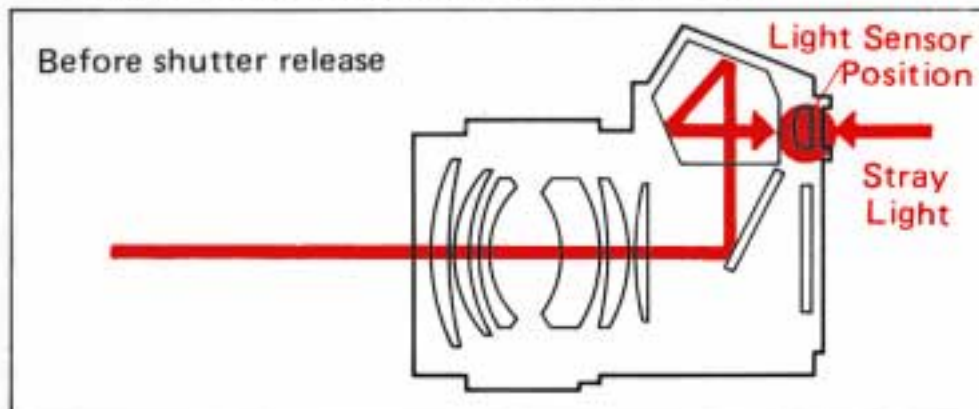

▼ Diagram in light path in OM-2

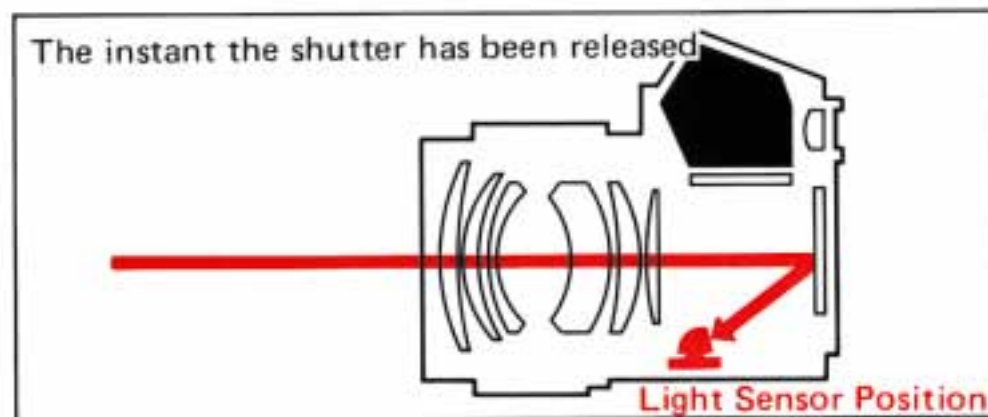
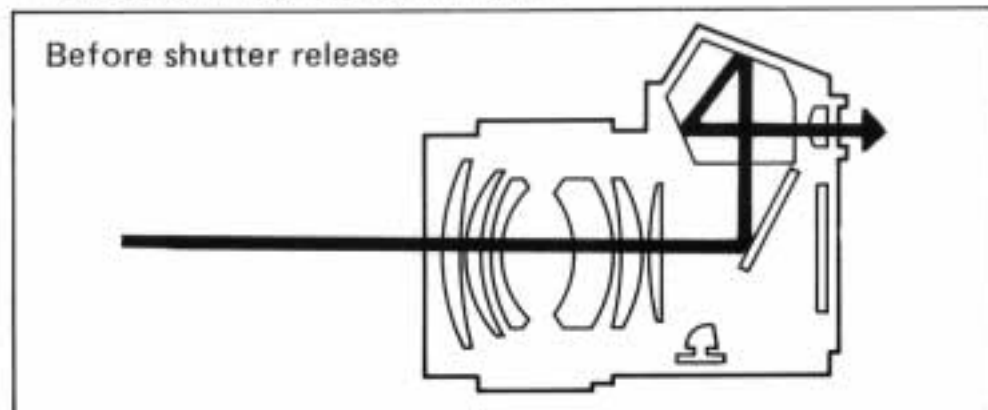

In the automatic mode, the OM-2 measures the subject brightness very differently from any other automatic camera — faster and with much more accuracy. With the OM-2, light entering the lens is measured directly at the film plane by the sensors at the precise moment the film is being exposed. When sufficient light has reached the film, the electronic brain senses the information and instantly closes the shutter.

THE-FILM) LIGHT MEASURING

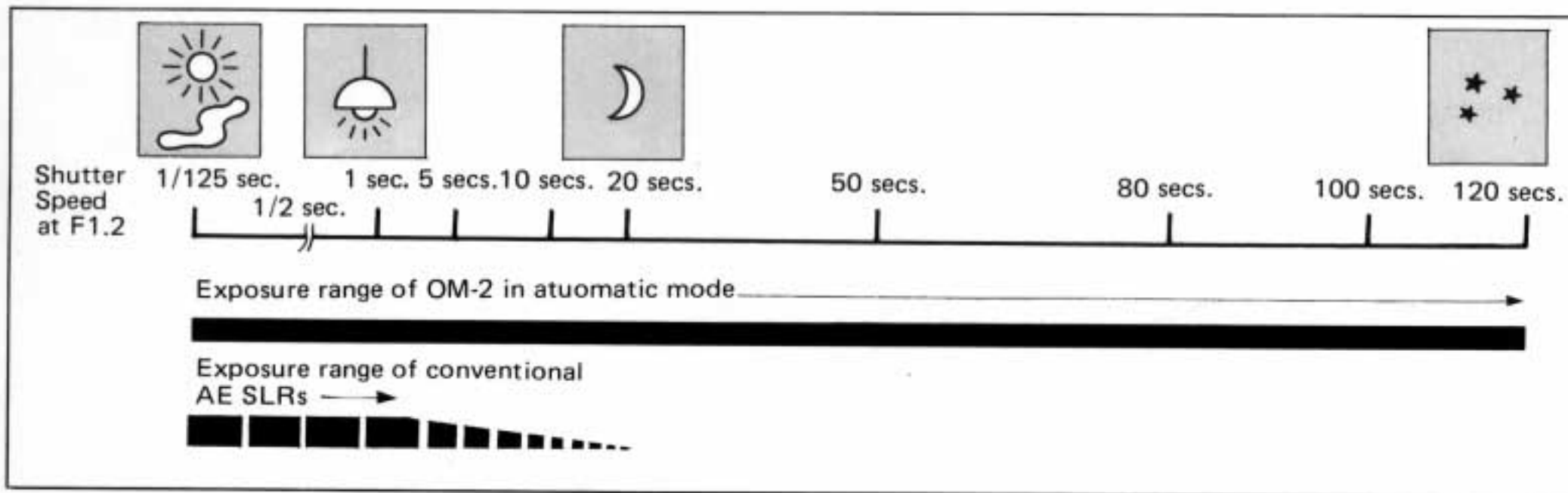

Advantageous Points of Through-The-Lens Direct (off-the-film) Light Measuring Method

1. The OM-2 sensors respond instantly to changes in the light during exposure and feed back the information to the shutter control mechanism.
2. The sensors measure flash intensity as it builds up and cut off its light at the source when the correct exposure level is reached. (TTL Centralized Control Flash)
3. Even during 5-frame-per-second motor drive operation, this Method insures correct exposure for each frame individually.
4. The Method operates accurately in far dimmer light than other systems. ASA 100 film can be automatically exposed for up to 120 seconds at F1.2.
5. The Method excludes all possibilities of stray light leaking through the camera eyepiece and affecting the exposure reading.
6. The Method gives correct exposures even when the clear-field type focusing screen is in use.



The OM System is comprehensively arrayed to meet an ever-expanding universe of photographic conditions for any subjects from the stars to microorganisms.

A full-scale system camera is distinguishable by some of the prerequisite characteristics as broadly mentioned below:

- Interchangeability of focusing screens.
- Adaptability to high speed motor drive photography.
- A wide range of high quality system components, including interchangeable lenses.
- Tough and reliable shutter, viewfinder, etc. that withstand harsh handling without failing.

When these exacting conditions have been satisfied, an OM-2 is born as a true system camera that controls an entire SLR comprehensive system. The OM-2 is backed up with over 300 components systematically organized under eight groups – Interchangeable Lens, Finder, Flash, Motor Drive, Phototechnical, Macrophoto, Photomicro and Case.

ZUIKO INTERCHANGEABLE LENS GROUP



One of many advantages of the single lens reflex type of camera is the large variety of interchangeable lenses available. The Zuiko Interchangeable Lens Group (designed and manufactured by Olympus) comprises 33 lenses including those now in the course of development. Zuiko lenses have always enjoyed a high reputation in photographic circles — new design technology has made possible a new series of innovative, high performance lenses. These lenses have a host of special features including new construction that compensates for close focus aberrations, increased aperture ratio in the wide angle lenses, and reduction in telephoto lens size and weight. The OM System adopts 49mm filters for most lenses from 21mm to 200mm. As part of the OM System design all the lenses now offer higher performance in small configurations. Olympus has produced lenses for microscopes for decades and the new Zuiko lenses benefit from this scientific experience. See the "OM System Zuiko Interchangeable Lenses" instructions for further information.





TABLE OF INTERCHANGEABLE LENSES

(Specifications subject to change without notice.)

TYPE	INTERCHANGEABLE LENSES		ANGLE OF VIEW	OPTICAL CONSTRUCTION ELEMENT-GROUP	DIA-PHRAGM	F STOP RANGE	MIN. FOCUS (meters) (ft.)	MIN. FIELD
FISHEYE	ZUIKO FISHEYE	8mm F2.8	180° (circle)	11-7	AUTO.	2.8-22	0.2 m (0.7)	
	ZUIKO FISHEYE	16mm F3.5	180°	11-8	AUTO.	3.5-22	0.2 m (0.7)	
SUPER WIDE	ZUIKO MC	18mm F3.5	100°	11-9	AUTO.	3.5-16	0.25m (0.8)⊙	30×20cm
	ZUIKO MC	21mm F2	92°	11-9	AUTO.	2-16	0.2m (0.8)⊙	21×14cm
	ZUIKO	21mm F3.5	92°	7-7	AUTO.	3.5-16	0.2 m (0.7)	21×14cm
	ZUIKO MC	24mm F2	84°	10-8	AUTO.	2-16	0.25m (0.8)⊙	23×15cm
	ZUIKO	24mm F2.8	84°	8-7	AUTO.	2.8-16	0.25m (0.8)	23×15cm
WIDE	ZUIKO MC	28mm F2	75°	9-8	AUTO.	2-16	0.3 m (1.0)⊙	27×18cm
	ZUIKO	28mm F3.5	75°	7-7	AUTO.	3.5-16	0.3 m (1.0)	27×18cm
	ZUIKO MC	35mm F2	63°	8-7	AUTO.	2-16	0.3 m (1.0)	21×14cm
	ZUIKO	35mm F2.8	63°	7-6	AUTO.	2.8-16	0.3 m (1.0)	21×14cm
	ZUIKO SHIFT	35mm F2.8	63° (83° at max. shift)	8-7	MANUAL	2.8-22	0.3 m (1.0)	21×14cm
STANDARD	ZUIKO	55mm F1.2	43°	7-6	AUTO.	1.2-16	0.45m (1.5)	23×15cm
	ZUIKO	50mm F1.4	47°	7-6	AUTO.	1.4-16	0.45m (1.5)	24×16cm
	ZUIKO	50mm F1.8	47°	6-5	AUTO.	1.8-16	0.45m (1.5)	24×16cm
	ZUIKO MC MACRO	50mm F3.5	47°	5-4	AUTO.	3.5-22	0.23m (0.8)⊙	72×48cm
ZOOM	ZUIKO MC ZOOM	35-70mm F3.6	64°-34°	10-8	AUTO.	3.6-22	0.8 m (2.7)	48×72cm~25×37.5cm
	ZUIKO ZOOM	75-150mm F4	32°-16°	15-11	AUTO.	4-22	1.6 m (5.2)	64×42cm~32×21cm
	ZUIKO MC ZOOM	85-250mm F5	29°-10°	15-11	AUTO.	5-32	2 m (6.0)	66×44cm~23×15cm
TELEPHOTO	ZUIKO MC	85mm F2	29°	5-4	AUTO.	2-16	0.85m (2.8)⊙	29×19cm
	ZUIKO	100mm F2.8	24°	5-5	AUTO.	2.8-22	1 m (3.3)	29×19cm
	ZUIKO MC	135mm F2.8	18°	5-5	AUTO.	2.8-22	1.5 m (4.9)	32×21cm
	ZUIKO	135mm F3.5	18°	5-4	AUTO.	3.5-22	1.5 m (4.9)	32×21cm
	ZUIKO MC	180mm F2.8	14°	5-5	AUTO.	2.8-32	2 m (6.0)	32×21cm
	ZUIKO MC	200mm F4	12°	5-4	AUTO.	4-32	2.5 m (8.2)	36×24cm
	ZUIKO	200mm F5	12°	6-5	AUTO.	5-32	2.5 m (8.2)	36×24cm
SUPER TELEPHOTO	ZUIKO	300mm F4.5	8°	6-4	AUTO.	4.5-32	3.5 m (11.5)	33×22cm
	ZUIKO MC	400mm F6.3	6°	5-5	AUTO.	6.3-32	5 m (16.4)	36×24cm
	ZUIKO MC	600mm F6.5	4°	6-4	AUTO.	6.5-32	11 m (36.1)	55×37cm
	ZUIKO MC	1000mm F11	2.5°	5-5	AUTO.	11-45	30 m (98.4)	98×65cm
SPECIAL USE	ZUIKO MC MACRO	20mm F3.5	9° at highest mag.	4-3	MANUAL	3.5-16	W/Auto Bellows & PM-MT ob	max. 8×5mm min. 3×2mm
	ZUIKO MC MACRO	38mm F3.5	9° at highest mag.	5-4	MANUAL	3.5-16	W/Auto Bellows & PM-MT ob	max. 20×13mm min. 6×4mm
	ZUIKO MC 1:1 MACRO	80mm F4	9° at highest mag.	6-4	MANUAL	4-22	W/Auto Bellows	max. 72×48mm min. 18×12mm

⊙ Automatic correction design against close distance aberrations.

 Compatible: The meter needle indicates correct light readings. In the combination marked with *, microprism, split-prism and edges of the finder darken.

 Compatible: The meter needle does not give correct light readings.

WEIGHT (oz.)	LENGTH	MAX. DIAMETER	HOOD	FILTER	1-1	1-2	1-3	1-4	1-5	1-6	1-7	1-8	1-9	1-10	1-11	1-12	1-13	1-14
					Micro-matte type	Micro-matte type	Split-matte type	All-matte type	Micro-clear field type	Micro-clear field type	Micro-clear field type	All-matte type	Clear field type	Checker-matte type	Cross hairs-matte	Cross hairs-clear	Micro split-matte	Micro split-matte
640g (22.6)	82mm	102mm	—	Built-in														
180g (6.3)	31mm	59mm	—	Built-in		*												
250g (8.8)	42mm	62mm	49→72mm	Screw-in		*												
250g (8.8)	43.5mm	60mm	55mm	Slide-on		*												
180g (6.3)	31mm	59mm	49mm	Screw-in		*												
280g (9.9)	48mm	60mm	55mm	Screw-in		*												
180g (6.3)	31mm	59mm	49mm	Screw-in		*												
250g (8.8)	43mm	60mm	49mm	Screw-in		*												
180g (6.3)	31mm	59mm	49mm	Screw-in		*												
240g (8.5)	42mm	60mm	55mm	Screw-in														
180g (6.3)	33mm	59mm	51mm	Slide-on														
310g (10.9)	58mm	68mm	49mm	Slide-on	*	*	*											
310g (10.9)	47mm	65mm	57mm	Slide-on														
230g (8.1)	39mm	60mm	51mm	Slide-on														
170g (6.0)	31mm	59mm	51mm	Slide-on														
200g (7.1)	40mm	60mm	—	49mm														
420g (14.8)	74mm	68mm	60mm	Slide-on														
440g (15.5)	115mm	63mm	Built-in	49mm														
890g (31.4)	196mm	70mm	Built-in	55mm														
260g (9.5)	48mm	60mm	49mm	Screw-in														
230g (8.1)	48mm	60mm	49mm	Screw-in														
360g (12.7)	80mm	61mm	Built-in	55mm														
290g (10.2)	73mm	60mm	Built-in	49mm														
700g (24.7)	124mm	80mm	Built-in	72mm														
510g (18.0)	127mm	67mm	Built-in	55mm														
380g (13.4)	105mm	62mm	Built-in	49mm														
1100g (38.8)	181mm	80mm	Built-in	72mm														
1300g (46.0)	255mm	80mm	Built-in	72mm	*		*											
2800g (98.8)	377mm	110mm	Built-in	100mm	*		*											
4000g (141.0)	662mm	110mm	Built-in	100mm	*	*	*											
70g (2.5)	20mm	32mm	—	21mm Slide-on	*	*	*	*										
90g (3.2)	28mm	43mm	—	32mm Slide-on	*	*	*											
200g (7.1)	46mm	59mm	—	49mm	*	*	*											

INTERCHANGEABLE LENS GROUP UNITS

■ Filters

Filters are essential to the effective rendition of photographic subjects. In controlling contrast and eliminating unwanted haze in black and white photography, the use of the correct filter often means the difference between a good photograph and a great one. In color, where the balancing of the light with the film emulsion is absolutely necessary for correct color, conversion and light balancing filters are the only effective way of achieving the desired results.

* Be careful not to use two filters simul-

taneously in order to avoid unintentional cut in the periphery of a photograph.

■ Lens Hoods

Lens hoods protect against extraneous light striking the lens and causing unwanted glare. Hoods for standard lenses are cover types and can be reversed to provide easy storage even when the camera is in the case.

Five lens hoods are optionally available (see TABLE OF INTERCHANGEABLE LENSES on p. 47 & 48.)

■ Camera Body Cap

■ Rear Lens Cap

■ Front Lens Caps

(49mm, 55mm, 72mm and 100mm in diameter)

■ Adapter Ring 49 → 72mm

A lens hood/filter mount for the 18mm F3.5 lens.



Application	Name	Color	Description	Diameter			
				49mm	55mm	72mm	100mm
B. & W. and Color	Skylight (1A)	Colorless	Similar to UV filter. Eliminates ultraviolet rays. Reduces haze and bluish tones in daylight photography. Effective with color film only. May be used at all times to protect the lens.	○	○	○	○
	L39 (UV)	Colorless	Eliminates undesirable ultraviolet rays which cause dull, flat pictures. Renders subject in clear, detailed brilliance. May be used at all times to protect the lens.	○	○	○	○
	ND2 ND4	Grey Grey	Reduces the quantity of light entering the lens to 1/2 or 1/4 of the original intensity. For use in extremely bright conditions when you wish to maintain a wide aperture.	○	○	—	—
	Polarizing filter POL	—	Enables you to take pictures through glass or water without reflections. Will darken the sky in black-and-white photographs without altering other color values in the picture, and renders blue skies darker when used with color film. Reflections are reduced to provide better texture surface detail.	○	○	—	—
B. & W.	Y48 (Y2)	Yellow	Accentuates contrast, darkens blue skies. Very effective in daylight scenes where the sky is part of subject matter. Heightens the effect of white clouds. Useful in copying documents where line copy is blue or black on light background.	○	○	○	○
	056 (02)	Orange	Absorbs a wider range of wavelengths from UV to dark green than the Y2. Makes a superb rendition of the texture of outdoors subjects, and indoors. It brings out detail in objects yellow, brown. Used with infrared film.	○	○	○	○
	R60 (R1)	Red	Used as contrast filter to create darkened sky or in copying. Also used to penetrate haze in landscape photography for stronger contrast than an O2 filter. Used with infrared film.	○	○	○	○
Color	A4 (B1C)	Amber	For use when taking color pictures in cloudy or rainy weather. Reduces bluish tone.	○	○	—	—
	B4 (B2C)	Blue	Designed for use when taking color pictures in early morning or late evening hours when red rays are predominant.	○	○	—	—

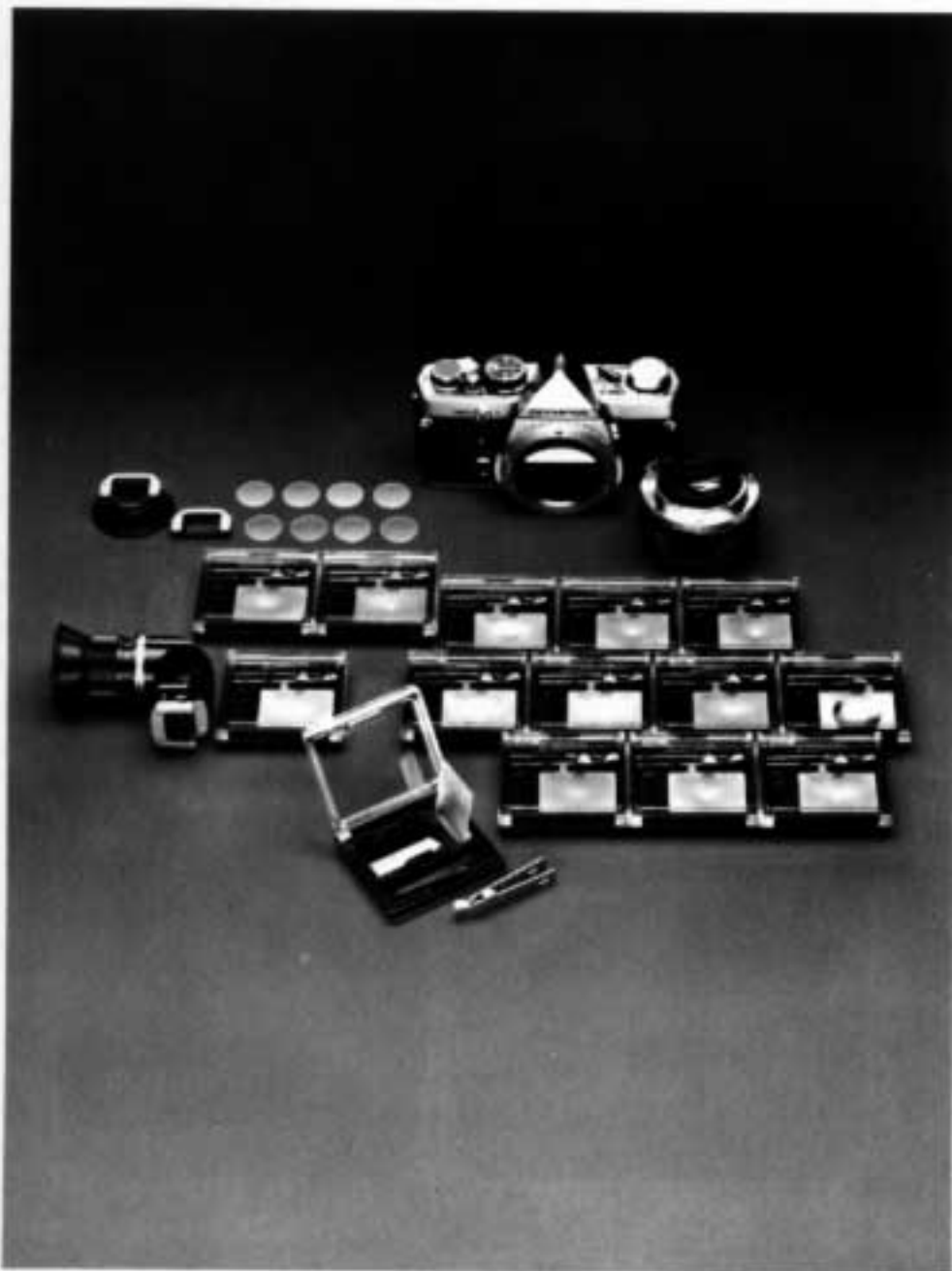

The viewfinder is one of the most important features of a single lens reflex camera. Since every photographic subject is turned into a visual image by means of the finder, a finder that is dark or difficult to look through is an obstacle to good photography. However enriched the SLR camera is with a wide range of interchangeable lenses, this SLR cannot be expected to fulfill its essential function without the provision for changing of focusing screens. The OM-2 is provided not only with an electronic shutter, but also with a viewfinder that offers a far brighter, larger image than previous 35mm SLR cameras. The Finder Group supplements this basic advantage with a comprehensive set of 14 Focusing Screens for a wide variety of applications from photomicrography to astrophotography. Unless the most suitable focusing screen for a given photographic purpose is available, the potentialities of a system camera cannot be utilized. For fast, accurate focusing, the OM System Finder Group offers the unique Varimagni Finder with a magnification selector, the Eyecup 1 that accepts a variety of Dioptric Correction Lenses, Eyecoupler, etc.

FINDER GROUP UNITS

■ Varimagni Finder

This unique and exclusive unit for the OM System combines the two functions of angle finder and magnifier, incorporating 9 lens elements and a reflector. It fits over the camera's eyepiece, and can be adjusted for individual eyesight. Its eyepiece tube is rotatable through 360°



for use in low level and 90° angled shots. The two-stage, one-touch switching system offers both a 1.2x magnification image covering the whole screen, and a 2.5x enlargement of the central portion for critical focusing. For photomicrographic use, insert the Eyecoupler between the camera and Varimagni Finder.

■ Eyecup 1

Attached by sliding over the OM Body eyepiece. With its attached rubber hood it prevents stray light from entering through the eyepiece, an essential requirement in light measuring. The Eyecup 1 is provided with a slot for Dioptric Correction Lenses.



■ Eyecoupler

Connects the Varimagni Finder to the OM Body for photomicrography. It also ensures full coverage of the bright viewfinder field for use of the Eyecup 1 in conjunction with the Motor Drive 250 Film Back.

■ Focusing Screen 1

Interchangeable Focusing Screens are often thought of as a luxury feature in 35mm photography. Yet the Standard Focusing Screen 1-13 is often inconvenient or difficult to use, and in some circumstances it is quite unsatisfactory. With super-telephoto lenses for instance, the microprism becomes excessively dark. With the high magnifications of macro-photography and photomicrography, it is impossible to focus.

The feature of each Focusing Screen is listed at right. The 1-3, 1-13 and 1-14, suitable for general photography, are particularly advantageous when taking a subject with vertical lines. The 1-5 is ideal for the snap-shooters using a wide angle lens. The 1-4 and 1-7 are designed for super-telephoto lenses and 1-4, 1-10, 1-11 and 1-12 are for close-ups, macro-photography and photomicrography. The 1-5, 1-6, 1-7 and 1-9 are not used with the exposure meter built in the camera.

■ Dioptric Correction Lens 1

Available in 8 diopter corrections: +2, +1, 0 (for hypermetropia); -1, -2, -3, -4, -5 (for myopia). Used to match the photographer's vision, and especially necessary in fine focusing for high magnification. Fits into the Eyecup 1.

TYPE	SCREEN	FEATURES	TYPE	SCREEN	FEATURES
1-1 Microprism-matte type (for most lenses)		Standard type, suitable for general photography. Fast and accurate focusing is done on the central microprism spot as well as on the surrounding matte area. When a lens with a maximum speed of F5.6 or slower is used, the microprism darkens and focusing must be made on the matte area. The meter needle indicates proper exposures.	1-8 All matte type (for telephoto lenses & astronomical telescopes)		This screen is ideal for use with super telephoto lenses of 300mm or more in focal length, or for astrophotography. The extreme fineness of the matte surface permits outstanding field definition. More accurate focusing may be achieved by the use of the VariMagn Finder.
1-2 Microprism-matte type (for standard & telephoto lenses)		Suitable for general photography in conjunction with a standard or telephoto lens. Focusing is done on the microprism spot as well as on the matte area. When a lens with a maximum speed of F8 or slower is used, the microprism spot darkens. The meter needle indicates proper exposures.	1-9 Clear field type (for endoscopic photography)		Designed for use with OLYMPUS fiberoptic endoscopes. This condenser type screen without beam lens requires no focusing when a special adapter couples the camera with the fiberoptic. Exposure is made automatically by the light supply.
1-3 Split image-matte type (for most lenses)		Suitable for general photography ensuring critical focusing, and ideal for photographers who prefer the split field and coincidence type focusing. When a lens with a maximum speed of F5.6 or slower is used, the split prism darkens. The meter needle indicates proper exposures.	1-10 Checker-matte type (for Shift lens)		The grid lines engraved on the all-matte surface are used for vertical and horizontal picture alignment. Though originally designed for architectural photography with the Shift lens, it is also suitable for general and super-telephotography, and close-up/macrophotography with macro lenses and Auto Bellows.
1-4 All matte type (for most lenses)		Suitable for general photography and ideal for photographers who prefer a view field free from microprism or split prism and for those who are accustomed to focus using matte area. Also suitable for super telephoto photography and close-up photography in conjunction with macro lenses and Auto Bellows. The meter needle indicates proper exposures.	1-11 Cross hairs-matte type (for close-up & macro-photography)		Highly advantageous for close-up and macrophotography with Auto Bellows and extension tubes. For focusing in low magnification close-up photography, use the matte area, and in macrophotography greater than life size, use the double cross hairs the same way as with the 1-12. The meter needle indicates proper exposures, but depending on the conditions of the specimen, the reading must be compensated for.
1-5 Microprism-clear field type (for wide angle & standard lenses)		This transparent screen provides an exceptionally bright finder image. Highly suitable for snapshots using wide angle lenses. The lack of matte surface means depth-of-field effects cannot be ascertained. The meter needle does not indicate proper exposures, because its movement varies depending on the lenses used.	1-12 Cross hairs-clear field type (for photo-micrography & macrophotography greater than life size)		The transparent screen offers the photographer focusing with an unusually bright finder image. To focus, first correct your diopter using a diopter correction lens or VariMagn Finder so that each line of the double cross hairs can be seen clearly and separately. Then bring the specimen into focus. The meter needle indicates proper exposures, but depending on the specimen's conditions, the reading must be compensated for.
1-6 Microprism-clear field type (for standard & Telephoto lenses)		This screen provides an extremely bright finder image. Focusing is done on the microprism spot. The lack of matte surface means depth-of-field effects cannot be ascertained and the meter needle does not indicate proper exposures.	1-13 Microprism/split image-matte type (for most lenses)		Most suitable for normal photography, this screen assures pinpoint focusing. The central split-image rangefinder is encircled by a microprism collar. Since the outer area has a matte surface, the screen can be used in the same way as the standard 1-1 and 1-3 Screens. When a lens with a maximum speed of F5.6 or slower is used, the prism darkens and the focusing must be made on the matte area.
1-7 Microprism-clear field type (for super telephoto lenses)		Developed primarily for use with super telephoto lenses, this clear field screen provides an extremely bright finder image. The microprism spot remains bright even with a lens whose maximum speed is F11. The lack of matte surface means depth-of-field effects cannot be ascertained, the meter needle does not indicate proper exposures.	1-14 Microprism/split image-matte type (for most lenses)		Most suitable for normal photography. The central split-image range finder, encircled by a microprism collar, is inclined 45 degrees to allow easy focusing on subjects with vertical or horizontal lines. When a lens with a maximum speed of F5.6 or slower is used, the split rangefinder darkens, so focusing must be made on the microprism collar or matte area. The meter needle gives correct light readings.

FLASH PHOTO GROUP



Flash is your own private "sun" when you take pictures at night, indoors, or daylight fill-in. At the moment of flash, you can even catch the movement of subjects that your own eyes are unable to follow.

The electronic flash has become accepted as the best form of artificial lighting. However, conventional "auto" flash units entail a number of shortcomings. TTL Centralized Control Flash, developed by Olympus for the first time in the world, fully overcomes the disadvantages that have hampered the conventional auto flash format. This new method makes use of TTL Direct (off-the-film) Light Measuring sensors and the electronic brain of the OM-2 to control flash emission directly through the camera. Its enormous versatility in use is ideally suited for the SLR camera, allowing full exploitation of the camera's interchangeable lens and other capabilities.

At present the OM System Flashphoto Group renders a choice of 4 different flash units including the Electronic Flash T20, which when used together with the OM-2, provides easier and more accurate flash photography than ever before.



FLASH PHOTO GROUP UNITS



■ Electronic Flash T20

World's first fully automatic electronic flash unit with a guide number of 20 (ASA 100, meters). When the OM-2 is set to "AUTO", the T20 automatically functions as a TTL Centralized Control Flash unit; when the OM-2 is set to "MANUAL", the T20 automatically functions as a manual flash unit. Provides charge/auto check viewfinder information. Can be used as a normal auto/manual flash unit with the OM-1 and other cameras.

■ Main Specifications

Unit type: Energy-saving series-circuit type TTL Centralized Control Flash unit (with normal "auto" and "manual" capability).

Guide number: 20 (ASA 100, meter) or 66 (ASA 100, feet).

Angle of coverage: Picture area of 35mm focal-length lens.

Flash duration: 1/40,000–1/1,000 sec.

Number of flashes: Approx. 120–500 flashes with AA 'penlight' alkaline batteries.

Recycling time: Approx. 0.2–10 sec. with AA 'penlight' alkaline batteries (varies depending on subject distance on Auto).

Connection to camera: Clip-on cordless type.

Exposure calculator: Reversible plate type ① blank for Olympus OM-2 (TTL Auto/Manual) ② calculator for OM-1 and other cameras (Normal Auto/Manual).

Flash modes: ① OM-2 . . . TTL Auto/Manual mode, automatically switched and controlled by OM-2. ② OM-1 . . . Normal Auto, 2 aperture choices (F4 and F8 at ASA 100); Manual.

Auto check: Auto check lamp flickers to indicate correct flash exposure has been made.

Power source: Two 1.5V AA 'penlight' batteries (including Ni-Cd batteries).

Dimensions: 77(D) x 68(W) x 57(H)mm (3 x 2.7 x 2.2")

Weight: 160g (5.6 oz.) less batteries.

■ TTL Centralized Control Flash by T20/OM-2 Combination

The T20 utilizes the OM-2's own built-in SBC light sensors. The sensors read the build-up of light from the T20 which passes through the taking lens to reach the film surface, letting the electronic brain of the camera cut off the flash emission when the correct exposure has been made.

On conventional auto flash units, the auto sensor is built into the flash unit. The sensor regulates flash emission independently of the camera. While normal auto flash units can also give a correct exposure, they are far less versatile and convenient in use. Their drawbacks include:

① The need to set film speed and lens aperture on both the camera and the flash unit, which leads to exposure errors caused by mistaken film speed and/or aperture alignment. → With the T20/OM-2 combination, once these values have been set on the camera there is no need to reset them on the flash unit.

② Restrictions on the f-number that can be used. → With the T20/OM-2, f-number can be selected freely because the

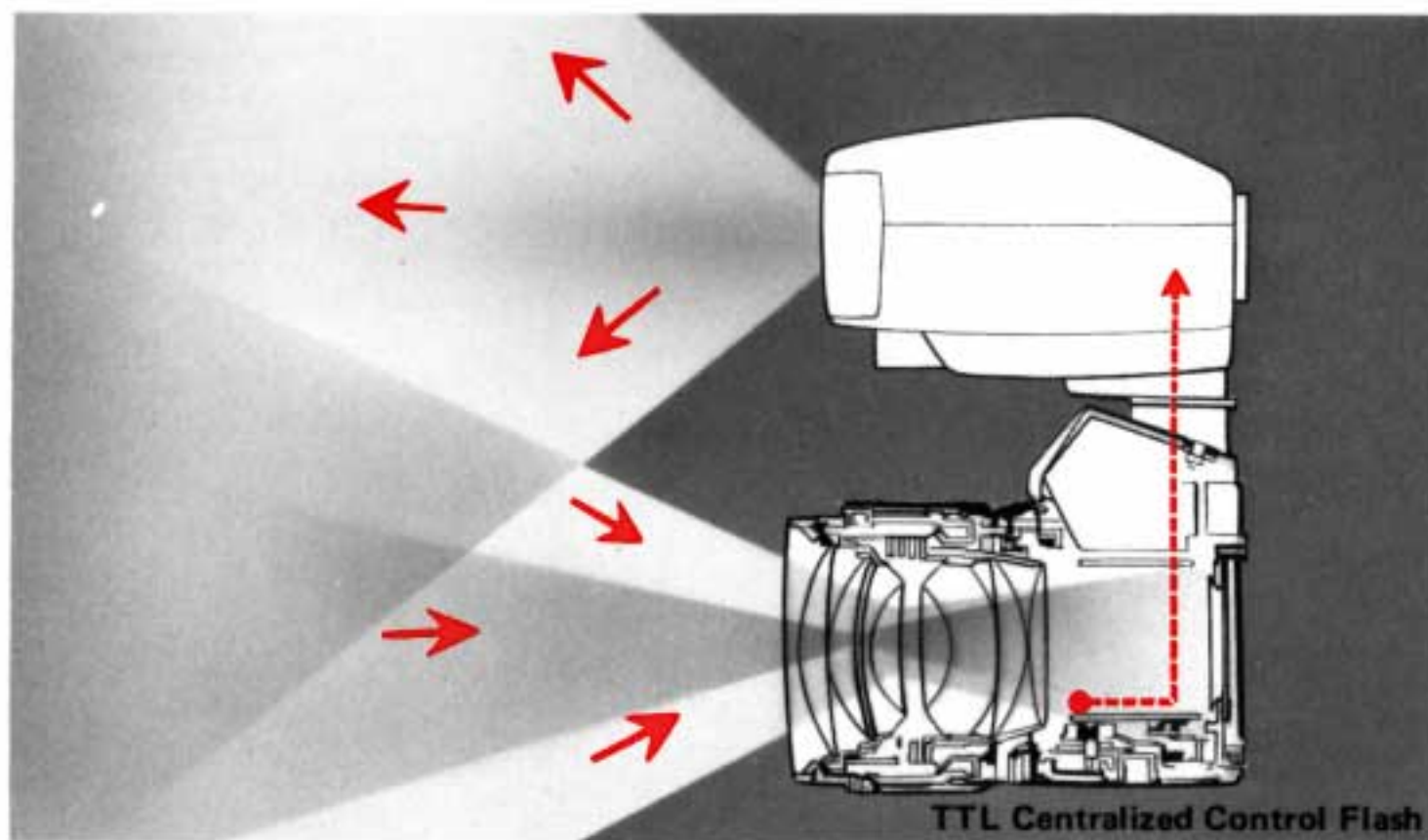

TTL Centralized Control Flash

light is measured through the camera lens.

③ Inability to change the light measuring angle of the sensor according to the taking angle of the chosen lens. → With the T20/OM-2, light measuring angle always coincides with the picture angle of the taking lens.

④ Restricted close-up range and incompatibility with extension tubes, etc. → With the T20/OM-2, close-up and diffused flash photography can be made easily. As the exposure is calculated inside the camera, the method of using the flash unit are entirely unrestricted.

FLASH PHOTO GROUP UNITS

■ Accessory Shoe 4

The Accessory Shoe 4 is screwed into the hot shoe socket on the OM Body (having the identification mark OM-1N or OM-2N) to provide direct contact with the clip-on type electronic flash.



■ Electronic Flash AC Adapter 2

(exclusively for use with T20)

Plugged into an AC wall outlet, this unit supplies a virtually unlimited number of flashes with the T20.

■ OLYMPUS PS200 Quick

The PS200 Quick is a compact electronic flash unit that operates on four 1.5V penlight batteries (alkaline or carbon/zinc) for use with the hot shoe cameras. This unit features a short recycling time from 2 sec. to 3 sec. Guide number 14 in meters (45 in feet), for



color and B&W films, ASA 80-100. Suitable for daylight type color films. Flash duration 1/1000 sec. Delivers about 200 flashes with a set of alkaline batteries. Measures 32 X 73 X 71mm (1.3" X 2.9" X 2.8"), weighing 95g (3.4 oz.) without batteries.

■ OLYMPUS PS200

The PS200 operates on two 1.5V penlight batteries for use with all the current OLYMPUS cameras and any other cameras with hot shoe contact. Guide number 14 (in meters) or 45 (in feet) at ASA 80-100. Suitable for daylight type color films. Recycling time approxi-



mately 7 sec. Delivers 200 flashes with a set of fresh alkaline batteries. Measures 31 x 55 x 64mm (1.2" X 2.2" X 2.5"), weighing 75g (2.6 oz.) without batteries.

■ **Quick Auto 310**

With a guide number of 34 (ASA 100, meters), this powerful flash unit offers a wide coverage to give enough illumination over the picture area of a 24mm super wide-angle lens without the aid of a wide adapter.



Operates off 4 penlight batteries with any direct contact camera. Can be used together with the Bounce Grip, permitting a choice of various power sources. (Nickel-cadmium batteries cannot be used.)

CAUTION: The flashphoto group units including the Bounce Grip are exclusively for use with the Quick Auto 310, and cannot be used with the T20.

■ **Lens Pouch 200**

Accommodates the Quick Auto 310.

■ **Lens Pouch 100**

A fine leather container for the Electronic Flash T20



MOTOR DRIVE GROUP



The attraction of the motor drive is its ability to capture fleeting phenomena which exceed the capabilities of human response. Tailored perfectly to match the OM camera body, each unit of the Motor Drive Group has been reduced in size to enhance its maneuverability and ease of operation.

The basic motor drive package (Motor Drive 1 + M. 18V Control Grip 1, or Motor Drive 1 + M. 15V Ni-Cd Control Pack 1) features an amazingly compact and lightweight design, permitting hand-held photography even with a 300mm telephoto lens, for shooting sports and news events or other action subjects. The Winder 1 unit, which is capable of automatic single-frame filming, was developed to leave the shutter always ready to capture the right opportunity. The 250 Film Back 1, which holds enough bulk film to give 250 exposures, attaches to the OM camera body without cords. The M. AC Control Box is useful for copy work, time-lapse and other photography by transforming household current to DC for motor drive use via a relay cord.

The many uses of the units of the Motor Drive Group in conjunction with other units of the Macrophoto, Photomicro and Flash Photo Groups permit even a greater range of photographic possibilities with the motor drive than originally imagined.



CHART OF MOTOR DRIVE GROUP

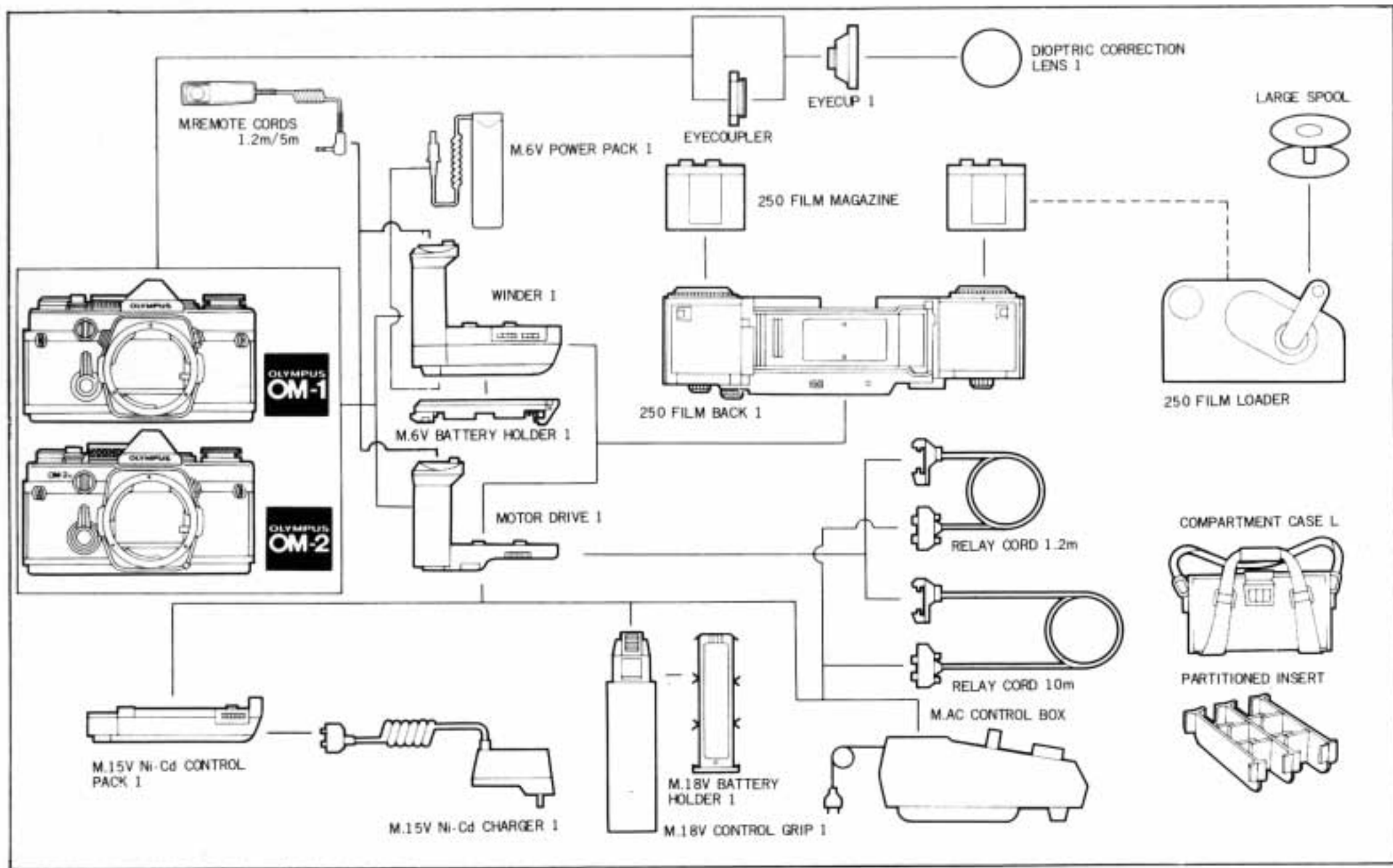

MOTOR DRIVE GROUP UNITS



■ Winder 1 (with M. 6V Battery Holder 1)

Attached directly to the camera base tripod socket, the Winder 1 functions integrally with the OM camera body to perform single frame shooting.

The unit winds the film in approx. 0.3 sec. as soon as the shutter release is pressed, and the exposure is made.



Operating on 4 self-contained AA Alkaline batteries, it is capable of powering approx. 50 rolls of 36-exposure film.

Size: 130 × 64 × 100mm (5.12 × 2.52 × 3.94 in.) Weight: 290g (10.2 oz.) (less batteries)

■ M. 6V Power Pack 1

This pocketable power unit (4 AA batteries) connects to the Winder 1 via

■ Motor Drive 1

The basic motor drive unit that forms the foundation of the group. Attached directly to the camera base tripod socket together with the power supply, it functions integrally with the OM camera body. Operating on various power sources such as penlight batteries, Ni-Cd batteries, or AC, it is capable of sin-



gle frame shooting and sequential filming of 5 frames per second.

Size: 116 × 82 × 66mm (4.57 × 3.23 × 2.59 in.) Weight: 210g (7.4 oz.)

a 1.2m cord. Warmed by photographer's body heat, permits operation in temperatures as low as -10°C (14°F).

■ M. 18V Control Grip 1 (with M. 18V Battery Holder 1)

A power supply that accepts 12 AA Alkaline or Ni-Cd batteries. Can be attached quickly to the Motor Drive 1. Complete with a built-in release button, single and sequence selector switch and release lock lever.

Size: 136 × 87 × 32mm, Weight: 160g (less batteries)



■ M.15V Ni-Cd Control Pack 1

This is a flat-type rechargeable power unit equipped with a special built-in Ni-Cd battery to power the Motor Drive 1, and provides maximum continuous filming rate of 5 f.p.s. as well as single release capability.

Size: 129 × 35 × 67mm, Weight: 260g

MOTOR DRIVE GROUP UNITS

■ M.AC Control Box

AC transformer for use with household current. Incorporates a selector switch between single-frame operation and sequential exposure operation, a terminal for the relay cord and a timer for exposures in intervals from 4 frames per second to one frame every 120 sec.



■ M.15V Ni-Cd Charger 1

This unit is necessary to charge the M.15V Ni-Cd Control Pack 1. By charging for about 4 to 5 hours, the Control Pack is capable of powering sequential filming of 40 rolls of 36 exposure film.

■ 250 Film Back 1; 250 Film Magazine

Can be quickly attached to the OM Body in place of the standard camera back, and used with the Motor Drive 1 or Winder 1 for roll films up to 250 exposures (10m or 32.8ft long). Two Magazines are necessary, one magazine holds the bulk film and a second magazine is used as a film take-up.



■ Relay Cords 1.2m and 10m

Extension cords for remote control; one is 1.2m (3.9ft), the other is 10m (32.8ft).

■ 250 Film Loader

This unit is used in the darkroom for loading the 250 Film Magazine from 33m (100ft.) bulk film rolls. A built-in mechanism automatically stops loading at preset film lengths.



■ Compartment Case L

■ Partitioned Insert

Can be slung over the shoulder or carried by hand. If used with an optionally available partitioned insert, the Case L accommodates motor drive equipment.

■ M.REMOTE CORDS 1.2m/5m

The M. Remote Cord remote-controls the Olympus Motor Drive 1 and Winder 1 units equipped with a remote control jack by a flick of a switch.



As a leading manufacturer of optical instruments, OLYMPUS produces a wide variety of microscopes, medical and measuring instruments that are making major contributions in many fields of modern life. They are also vital elements in the OM System which many scientists can use to successfully document their achievements in photographs. OLYMPUS products include operation microscopes for microsurgery; astronomy telescope adapter to explore the mysteries of space and stars — all capable of attachment to the OM Body.

For OLYMPUS Pen F and FT enthusiasts, a mount adapter is available for connection of these cameras to the OM System Interchangeable Lenses and other units. Another outstanding advantage the OM System offers is the Recordata Back 2 that is interchangeable with the OM camera back. Once in place, the Back imprints numerical and alphabetical symbols directly on the picture when the exposure is made, of great convenience in documentation, information filing, instant picture classification, etc.



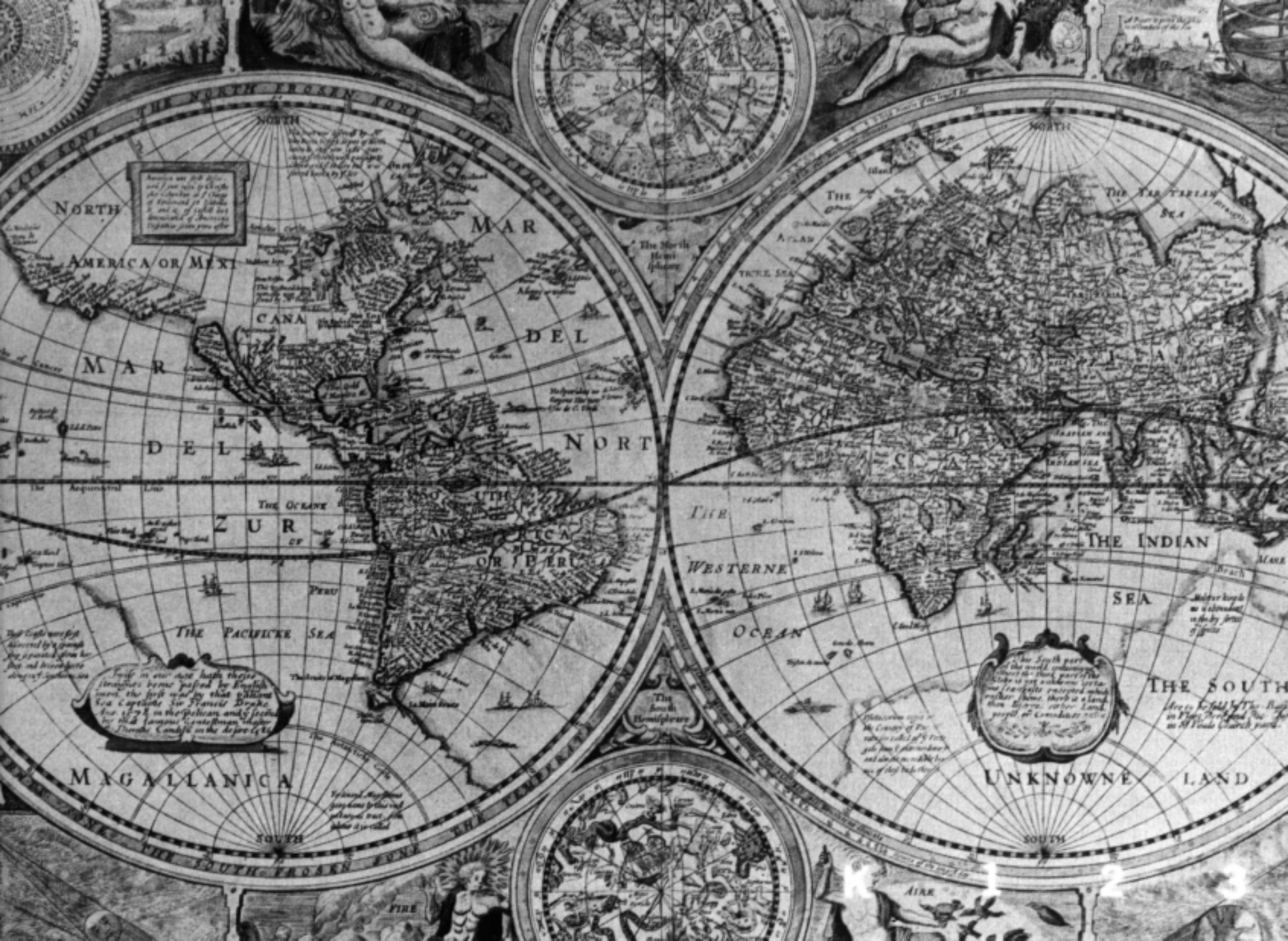

America was first discovered by Christopher Columbus in 1492, and was named after Amerigo Vesputi, an Italian explorer who sailed with Columbus.

Spain in our age hath these islands borne, which by English were the first year by that valiant Sea Captaine Sir Francis Drake Anno 1578 in the Pelican, and first by Sir Thomas Cavendish in the Desire 1591.

The South part of the world, unknowne to the ancients, was first discovered by the English Captaine Sir James Cook in the Endeavour Anno 1770, who discovered the South Sea Islands, and the continent of New South Wales.

See is to hold by The Bay in Flinders Bay, and the Bay in St. Pauls Church yard.



CHART OF PHOTOTECHNICAL GROUP

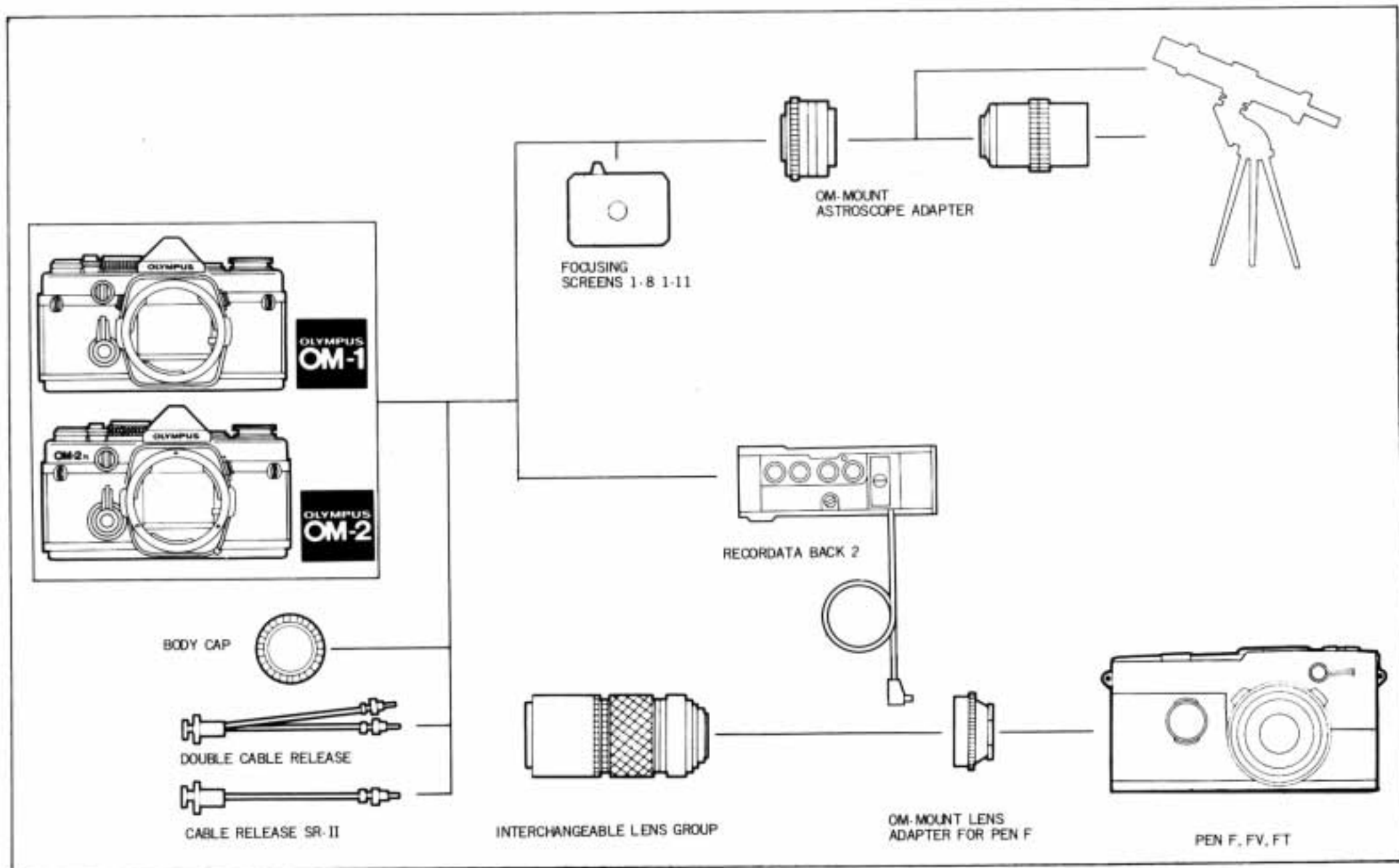

■ Recordata Back 2

This unit fits on the OM camera back in place of the standard camera back and imprints data in the lower right corner of the photograph. Data comprises year, month, day or figures and alphabetical symbols in 4 different combinations.

When imprinting is not required, the selector switch can be set to the OFF position. The use of the Recordata Back 2 is of great convenience in documentation, information filing, instant



picture classification, etc. by data imprinting even during high speed sequence photography with the Motor Drive 1, or flash photography. Powered by two 1.5V silver oxide batteries. The check light is built in to indicate data imprinting at the moment of the exposure. This unit measures only 26mm (1 in.) thick, fitting to the camera very neatly, allowing convenient carrying, weighing only 105g (3.4 oz.) less batteries.

■ OM-Mount Astroscope Adapter

Permits astrophotography by the OM Body attached to a telescope by means of the 36.5mm diam., pitch 1mm and pitch 0.75mm threads. It enables direct objective photography and high magnification photography through the telescope eyepiece.



■ Double Cable Release

Used with the Auto Bellows.

■ Cable Release SR-II

■ OM-Mount Lens Adapter for Pen F

Connects the OLYMPUS PEN F, FT and FV cameras to the OM System Interchangeable Lenses and other units.



MACROPHOTOGRAPHY GROUP



Due to recent advances in macrophotography, it has become possible to discover patterns and colors of unsuspected beauty in the minutiae of nature. A fast growing number of scientists and amateurs are taking the opportunity to explore the living world around them to a new depths.

The Macrophotography Group of the OM System provides all the tools necessary to capture this world of perfection on film, offering a complete range of convenient high performance accessories designed for specialists in the various fields of macrophotography. Starting from close-up photography with simple accessories such as Close-up Lenses, and Extension Tubes, you can extend your photographic excursions into the macrophoto world with the four Macro Lenses, Auto Bellows, Stands, Adapters, and a large variety of lighting equipment. This Group has no equal in its wide variety of accessories for macrophotography with a magnification range from 1/10x to about 10x., and heightens the value of the OM System in pursuit of perfection on film.



CHART OF MACROPHOTOGRAPHY GROUP

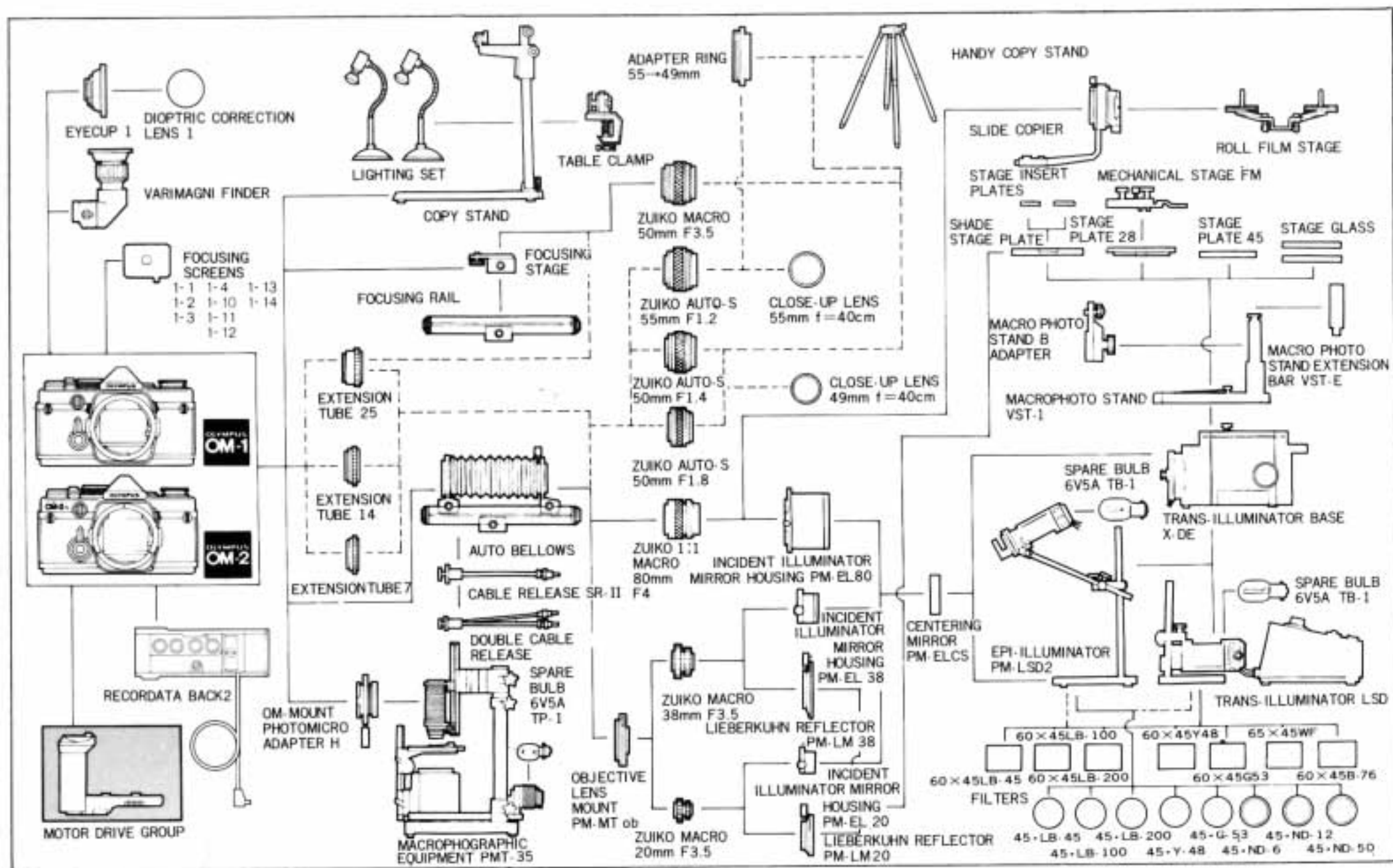

MACROPHOTOGRAPHY GROUP UNITS



■ Close-up Lens 49mm f=40cm

■ Close-up Lens 55mm f=40cm

Available in both 49mm and 55mm diameters to fit all suitable OM System lenses. Their use reduces the minimum focusing distance of a standard lens from 45cm (17.7") to 19cm (7.5") from the front lens surface.



■ Handy Copy Stand

A four-legged stand for close-up and copy photography. The leg length is adjustable to three positions.

■ Adapter Ring 55 → 49mm

Connects the standard F1.2 to the Handy Copy Stand or the reversed 55mm dia. lenses to the Auto Bellows.

■ Extension Tubes 7, 14 and 25

Bayonet mount tubes fitting between the OM Body and the lens. Available in extensions of 7mm, 14mm and 25mm, and can be used in total of 7 different combinations to give a variety of magnifications. When used with the 50mm F1.8, the lens-to-subject distance



can be changed from 39.1cm to 6.8cm (15.4" to 2.7"). With the Macro 50mm, the Extension Tube 25 provides an extended magnification range between 0.5x to life-size. (In this range, however, the 1:1 Macro 80mm is recommended for the best result.)

■ Copy Stand

A standard type stand, 48 x 44cm, for general close-up and copy photography. Two additional lights can be attached to the top of the 80cm high stanchion. Fine adjustment for the camera height and a locking device are provided.



■ Lighting Set

Complete with two units each consisting of a stable base and a light arm. Maximum light intensity is 500W.

■ Table Clamp

Convenient for setting up the column of the Copy Stand at the edge of a desk or table without the baseboard.

MACROPHOTOGRAPHY GROUP UNITS

■ Auto Bellows

A convenient, high performance bellows system, consisting of a bellows section, focusing rail and focusing tripod mount. Magnification and focusing are adjustable independently. A must for three Macro Lenses. Can also be used with the Focusing Stage.



■ Double Cable Release

Attached to the Auto Bellows and camera shutter release button, to activate them simultaneously.

■ Focusing Rail

This is used with the Focusing Stage and connects to a tripod, the Copy Stand, or Macrophoto Stand B Adapter, so that the camera can be smoothly moved along the Rail, allowing you to focus and compose as desired.



■ Slide Copier

For use in conjunction with the Auto Bellows to produce duplicates from frame-mounted slides or strip slides. The 1:1 Macro 80mm is recommended for best results with the Slide Copier.

■ Focusing Stage

Allows you to mount the camera body on the Focusing Rail or Auto Bellows. When used with the Rail, you can change the camera position for fast and smooth focusing and composing.



■ Roll Film Stage

Attached to the Slide Copier to hold long roll films for duplication.

■ Macrophoto Stand VST-1

A rugged stand specially designed for close-up and high magnification photography. Usable with various stage plates. Complete with a round frosted plate (black at back) for incident light, and a pair of stage clips.



■ Macrophoto Stand B Adapter

For use with the Macrophoto Stand, to support the Auto Bellows or Focusing Rail on the Stand.

■ **Macrophoto Stand Extension Bar VST-E** Extends the height of the Macrophoto Stand. Length: 7.5cm (2.95').

■ Trans-Illuminator Base X-DE

Indispensable for holding the Macrophoto Stand VST-1 for magnified photographs. Supplied with a built-in 100V 20W illuminator with a mirror, and a pair of wooden handrests for ease of operation. Can be used with various stage plates and filters. When used with



the Lieberkuhn Reflector, it is convenient to replace the reflector mirror with the Centering Mirror PM-ELCS.

■ Cable Release SR-II

For use with the OM Body or Auto Bellows to eliminate shutter vibration when the shutter is released.

■ Epi-Illuminators PM-LSD 2

This pair of illuminators offers vertical illumination essential to macrophotography. The height of the illuminator is adjustable on the tall pillar, suitable to overstage or substage illumination. When used with the Trans-Illuminator Base X-DE, the Illuminator supplies



transmitted light. Focusing is adjustable by shifting the bulb filament. A 6V to 8V variable transformer is provided. Eight filters are available in various sizes, including color, black and white, neutral density, etc. for transparent or translucent subjects.

MACROPHOTOGRAPHY GROUP UNITS

■ Trans-Illuminator LSD

This unit is a universal type trans-illuminator for use with the X-DE Trans-Illuminator Base. When the Lieberkuhn Reflector is added, vertical light is also available. A 6V, 30W bulb is built-in. The condenser travels 18mm by rack and pinion for converging, diverging and



parallel adjustments of light. Complete with transformer and square filter 60 x 45C. Provided with a filter holder for attachment of various OLYMPUS filters, round and square.

- Stage Glasses (Clear, frosted & black)
- Stage Plate 45 (metal disc, black)
- Stage Plate 28 (metal disc, black)
- Glass Shade Stage Plate

Supplied with two stage inserts; compatible with the Lieberkuhn Reflector. The center port accepts the stage insert on which a subject is placed.



■ Mechanical Stage FM

This stage is used to mount subjects on the 28mm stage plate. The subject travels vertically and horizontally by precise adjustments with a vernier.

- Spare Bulb 6V 5A TB-1 (for PM-LSD2 & LSD)
- Spare Bulb 6V 5A TP-1 (for PMT-35)
- Adapter PM-EA

Accepts the photosensitive probe of the EMM-7 Exposure Meter in conjunction with the PMT-35 or Auto Bellows.



■ Filters

Round filters are used with the PM-LSD2 and LSD, while square filters used with the LSD only. They are available for color temperature compensation, monochromatic, neutral density, diffusion, heat absorbing and interference filtration.

■ **Lieberkuhn Reflector PM-LM20**

■ **Lieberkuhn Reflector PM-LM38**

These reflectors are available for use with the 20mm and 38mm Macro Lenses. When used with the LSD Trans-Illuminator, they make it possible to take photographs with excellent penetration and lack of shadows.



■ **Objective Lens Mount PM-MTob**

This objective mount enables you to mount the Zuiko Macro 20mm and 38mm to the Auto Bellows. It also connects to the Light Shield Tube PM-SDM.

■ **Incident Illuminator Mirror Housings PM-EL80, PM-EL38 and PM-EL20**

These units are used with OLYMPUS Macro Lenses in conjunction with the Epi-Illuminator PM-LSD2 or Macro-photographic Equipment PMT-35 to illuminate macrophotographic objects with incident light. They are effective when shadowless pictures are desired.



■ **Centering Mirror PM-ELCS**

For use with these PM-EL units for accurate centration or for use with the Trans-Illuminator Base X-DE.

■ **Macrophotographic Unit PMT-35**

The PMT-35 is a complete macrophotographic system for OM System photography providing image magnification from 0.45x to 16.5x with transmitted or reflected light as desired. The standard set consists of 26 out of the 46 high precision units of OLYMPUS macro-



photo equipment. The OM Mount Photomicro Adapter H connects the OM Body to the PMT-35.

PHOTOMICROGRAPHY GROUP

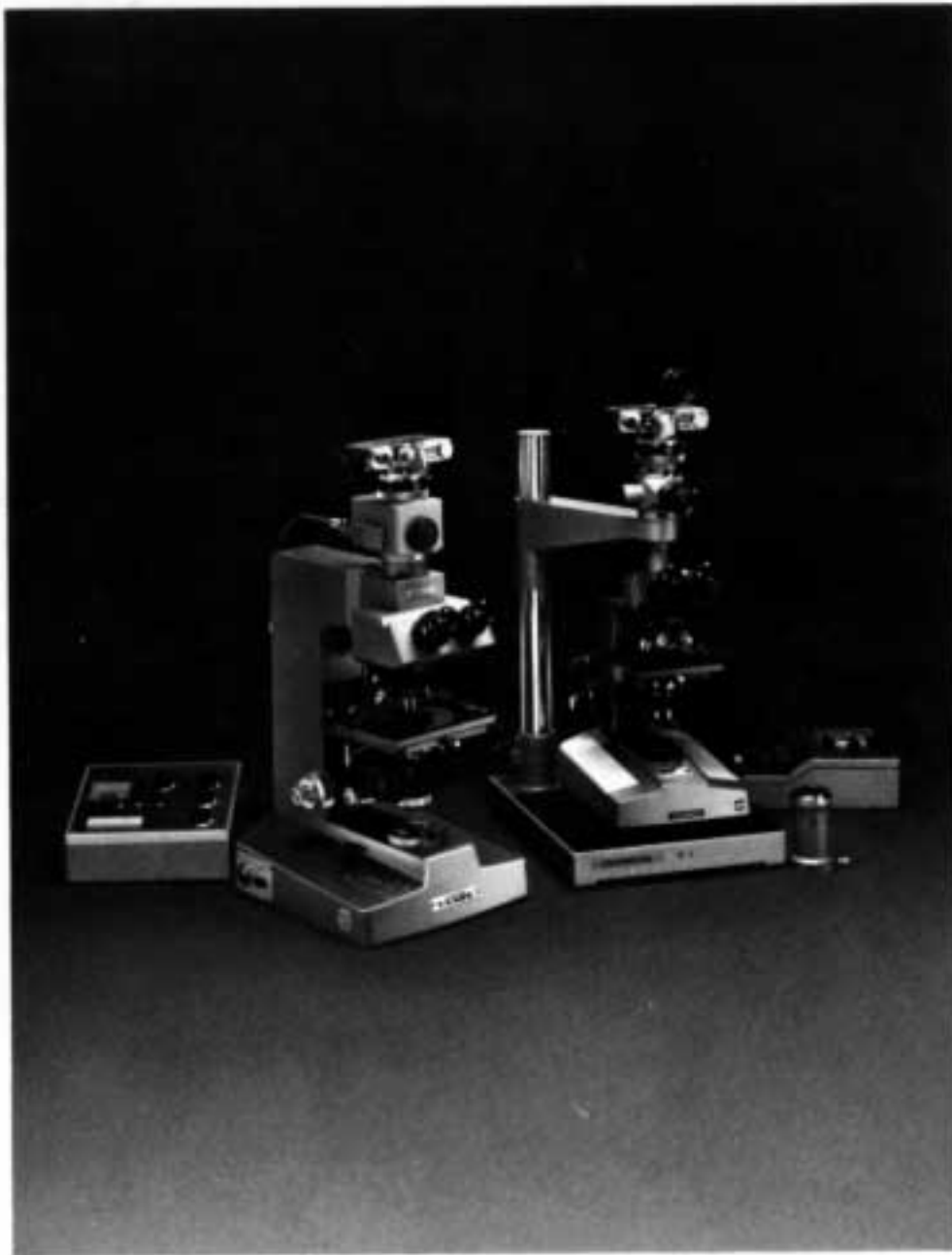

When the photographic magnification desired exceeds 10x, it becomes more difficult for the macrophotographic equipment alone to obtain excellent pictures. A sophisticated array of photomicrography accessories with a microscope as the central figure is required. The exciting vision of looking at the microscopic world through a microscope can be recorded by the OM-2.

OLYMPUS has an outstanding reputation for manufacturing precision microscopes used by scientists throughout the world. Naturally, the OM System includes a variety of microscope adapters, rugged stands, a special shutter to prevent vibration at high magnification, and an automatic exposure mechanism which solves the difficult problem of microscope exposures.

The Photomicrography Group is designed to expand the photomicrographic world not only into the scientific realm, but also into the creative sphere, so that the photographer's achievements under the microscope can be easily and accurately recorded with his OM-2.



CHART OF PHOTOMICROGRAPHY GROUP

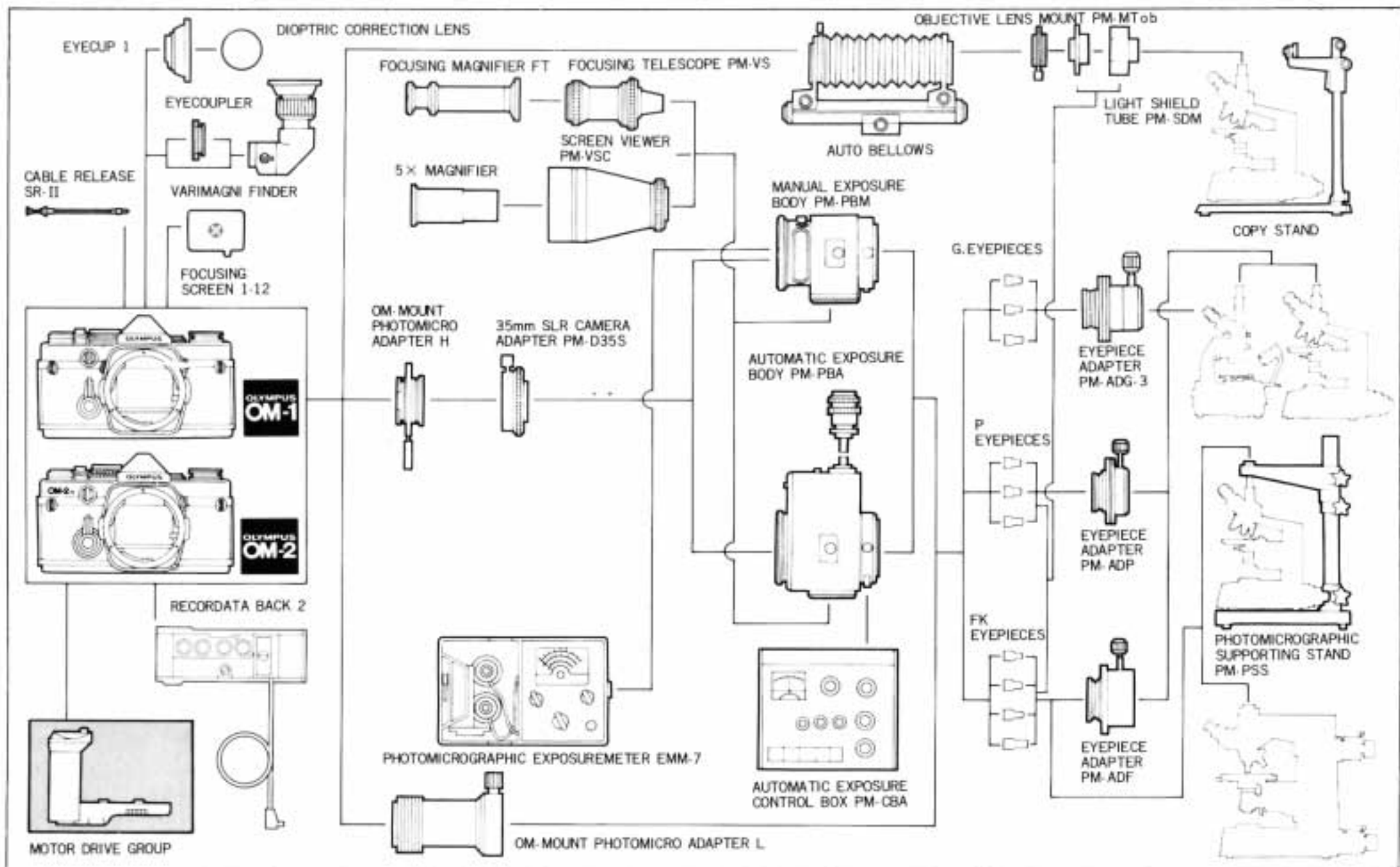

PHOTOMICROGRAPHY GROUP UNITS



- **OM-Mount Photomicro Adapter L**
Connects the OM Body to the microscope for low power magnification.



- **OM-Mount Photomicro Adapter H**
Connects the OM Body to the Photomicrographic System PM-10, automatic or manual, or Macrophotographic Unit PMT-35 for high power magnification.

- **35mm SLR Camera Adapter PM-D35S**

Used with OM-Mount Photomicro Adapter H to attach the OM Body to the PM-PBA or PM-PBM (see page 81).



- **Photomicrographic Supporting Stand PM-PSS**

This unit is a massive stand to virtually end the major cause of lost photomicrographs at high magnification due to vibration. Supports the entire camera weight, isolating it from the microscope.

- **Eyepiece Adapter PM-ADG-3, PM-ADP, PM-ADF**

Used to connect a microscope to the OM-Mount Photomicro Adapter L, PM-PBA or PM-PBM. Each Adapter designates OLYMPUS microscope eyepieces as follows; PM-ADG-3 for G eyepieces, PM-ADP for P eyepieces and PM-ADF for FK photo eyepieces.



- **Light Shield Tube PM-SDM**

Designed for use with the Auto Bellows and Objective Lens Mount PM-MTob. Assures excellent images when used with FK photo eyepieces at the bellows length of 111mm (4.4"), free of shutter vibration.

PHOTOMICROGRAPHY GROUP UNITS

■ Auto-Photomicrographic System PM-10-A

Consists of 17 units, including the PM-PBA, PM-CBA, etc.

- **Automatic Exposure Body PM-PBA**
Automatically determines accurate exposure time, compensating for reciprocity failure.

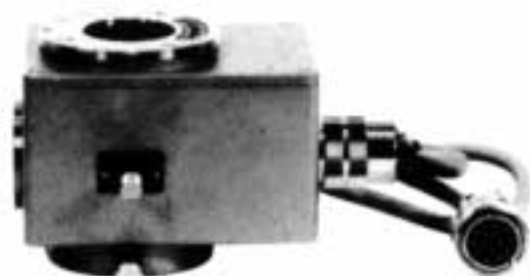

● Automatic Exposure Control Box PM-CBA

Used with the Automatic Exposure Body PM-PBA, to regulate color temperature control. Eight filters provided.

■ Manual Photomicrographic System PM-10-M

This is a popular manual version of the PM-10, consisting of 8 units.

- **Manual Exposure Body PM-PBM**
A special shutter release button is integrated to eliminate shutter vibration.



■ Photomicrographic Exposure Meter EMM-7

The EMM-7 assures accurate control of both exposure and color temperature in photomicrography. Provided with exposure and color temperature probes, and color-compensating filters.

■ Screen Viewer PM-VSC

For use with objectives lower than 4x power. A hood is provided to reduce extraneous light on the viewing screen.

■ 5X Magnifier

For use with the Screen Viewer for magnifying any part of the subject area and focusing accurately.



● Focusing Telescope PM-VS

For use with objectives 4x and up in conjunction with the Automatic or Manual Exposure Body.

■ Focusing Magnifier FT

Used to magnify the image obtained by the Focusing Telescope.

CHART OF PHOTOGRAPHIC RANGES

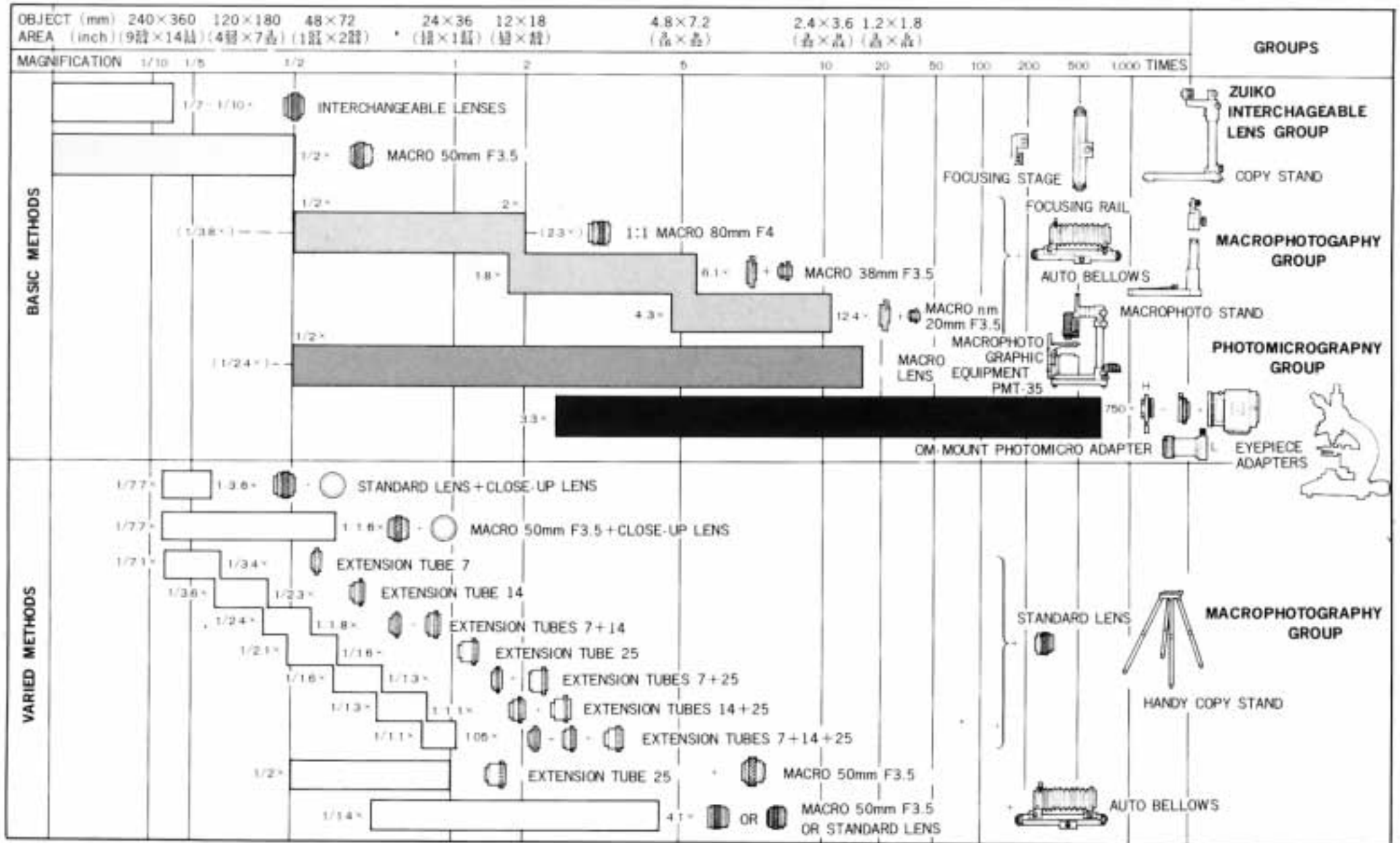

CASE GROUP

The Case Group includes a large variety of cases that the OM Body and other components fit properly.

Compartment cases are specially made of tough synthetic leather, designed to perfectly accommodate camera bodies, lenses, motor drive, electronic flash units, etc. The adjustable partitions can be rearranged in the case to suit the photographer's individual requirements. Soft, hard and semi-hard cases fit the OM Body and standard lenses, with a choice of carrying straps.

CASE GROUP UNITS

■ **Hard Case for OM Body with F1.8 or F1.4**

■ **Hard Case for OM Body with F1.2**
Accommodates the OM Body with respective standard lens.

■ **Semi-Hard Case for OM Body with F1.8 or F1.4**



■ **Semi-Hard Case for OM Body with F1.2**

■ **Soft Case for OM Body with F1.8 or F1.4**

Accommodates the OM Body with F1.8 or F1.4 standard lens, and the Recordata Back 2.

■ **Soft Case for OM Body with F1.2**

■ **Lens Pouch 100**

Made of fine leather to contain a single 100mm lens or smaller lens or Electronic Flash T20.

■ **Lens Pouch 200**

A fine leather container for a 200mm



telephoto lens, zoom lens, or smaller. Also holds the main body of the Quick Auto 310.

■ **Lens Pouch 300**

Accommodates 300mm and 180mm telephoto lenses.

■ **Various Shoulder Straps**

■ **Compartment Case S**

A hard shoulder case with two adjustable partitions. Holds OM Body, with two interchangeable lenses and filters, or with Quick Auto 310 and Bounce Grip.



■ **Camera Holder for Case M**

Besides the camera holder provided with the Case M, one more camera holder is attachable on the right or left wall of the case as preferred. These holders can hold two camera bodies simultaneously.

■ **Compartment Case M**

A soft shoulder case with partitions and two pockets. Holds OM Body, three interchangeable lenses and various auxiliary equipment including electronic flash. It also accommodates clothing and toiletry for travelling, in addition to photographic equipment,



permitting camera and lenses to be taken out freely. Removable partitions are provided to hold cameras and lenses in position safely without their individual cases, permitting quick lens changing on the camera inside the case. Two pockets outside the case hold for auxiliary photographic equipment.

■ **Compartment Case L**

A hard shoulder or hand-carried case with two adjustable partitions. Holds two OM Bodies, two interchangeable lenses (including 300mm telephoto lens), electronic flash, large format camera, and other equipment.



■ **Partitioned Insert**

When inserted into the Compartment Case L, this unit supports the assembly of the Motor Drive Units. The 250 Film Back 1 and interchangeable lenses can be stored together with the OM Body.

CHART OF CASE GROUP

Compartment Case S

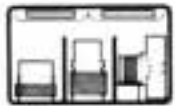

Compartment Case M

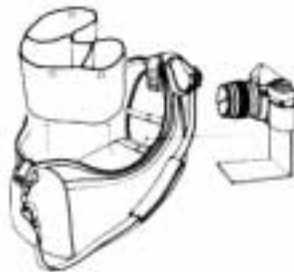
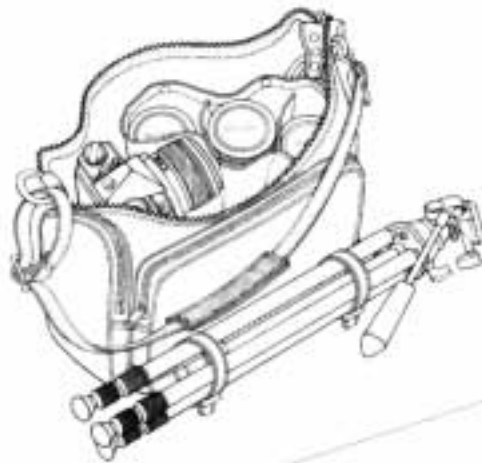

Compartment Case L

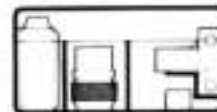
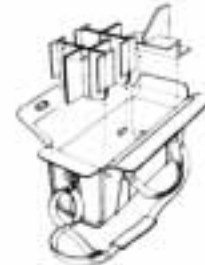
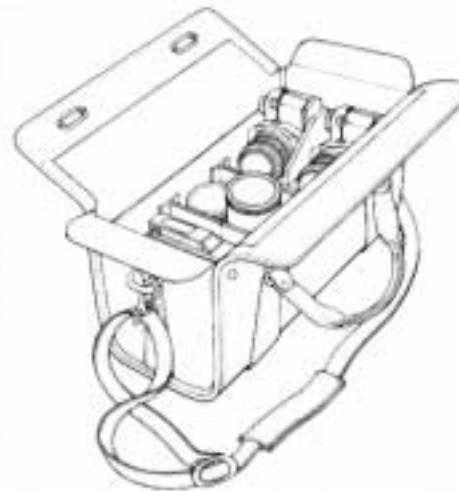

Motor Drive Partitioned Insert

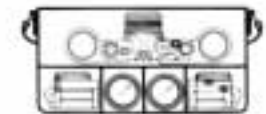
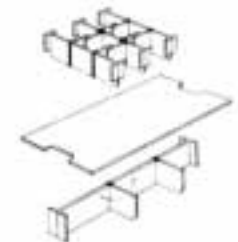
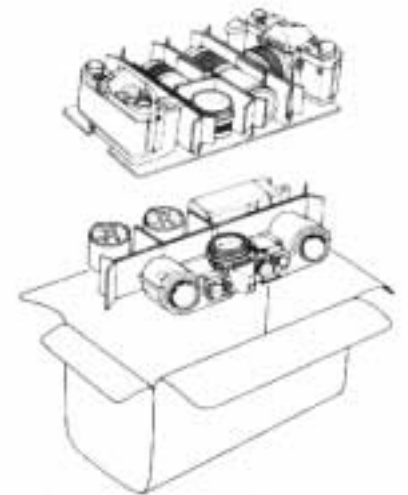

MEMO

Body No :

Lens No :

Others :

Name	
Address	



OLYMPUS

OLYMPUS OPTICAL CO., LTD.

43-2 Hatagaya 2-chome, Shibuya-ku, Tokyo, Japan Tel. 03-377-2111

OLYMPUS CAMERA CORPORATION

Crossways Park, Woodbury, New York 11797, U.S.A. Tel. 516-364-3000

OLYMPUS OPTICAL CO. (EUROPA) GMBH.

2 Hamburg 1, Steindamm 105, West Germany Tel. 040-248021

OLYMPUS OPTICAL CO. (U.K.) LTD.

2-8 Honduras Street, London EC1Y 0TX, England Tel. 01-253 2772