



E

OLYMPUS OM-3 Ti INSTRUCTIONS

Thank you for purchasing the OLYMPUS OM-3Ti. This durable, lightweight SLR camera incorporates titanium — a metal that's lighter than aluminum, yet six times stronger — in the camera body. It is a single lens reflex camera with a mechanical shutter. Features include Multi Spot Metering, OTF Auto Flash and Super FP Flash Control System. Designed to facilitate serious photography with such professional-level techniques as daylight synchro-flash photography, the purpose of the OM-3Ti is to expand the sphere of creative photography. Before using the camera, we recommend that you read this instruction manual carefully, familiarizing yourself with the operating instructions so you can get the very best performance and service life from your new camera.

Note: All the components of the Olympus OM-3Ti are carefully designed and their production and assembly is strictly controlled to enhance the unmatched performance of the system. If any interchangeable lenses, flashes, or accessories other than Olympus products are used, Olympus cannot be responsible for poor results or damage of the OM-3Ti.

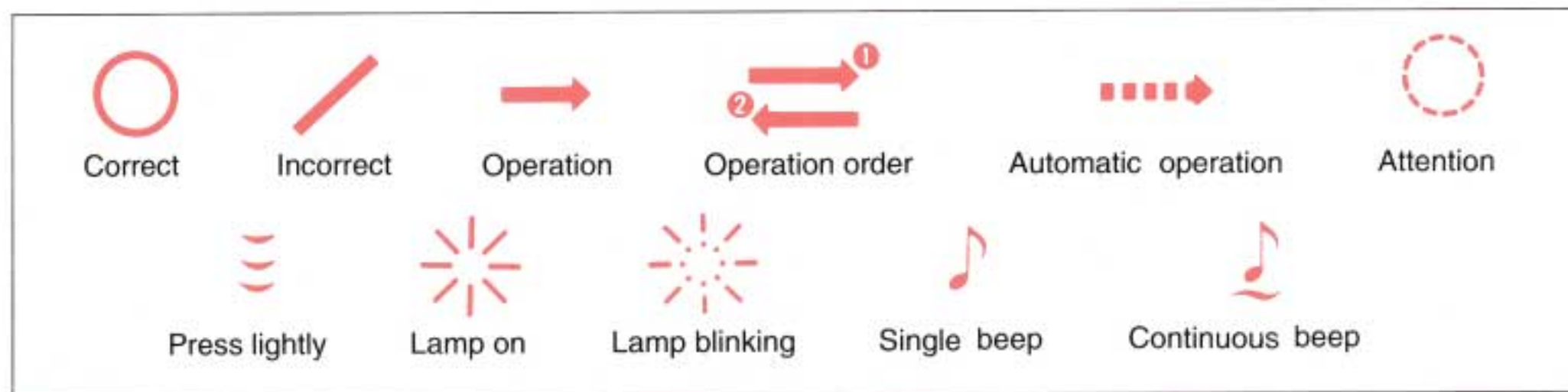

TABLE OF CONTENTS

< Preparation before Taking Pictures >

- Dioptric Correction 5
- Mounting the Lens 7
- Loading the Batteries 9
- Checking the Batteries 11
- Loading the Film 13
- Setting the ISO Film Speed 16

< Taking Photographs (I) >

— Center Weighted Average Light Metering —

- Center-Weighted Average Light Metering 19
- Rewinding the Film 22

< Taking Photographs (II) >

— Spot Metering —

- How to Use Spot Metering 25
- How to Clear Spot Metering 28
- How to Use the Multi-Spot Metering 29
- Highlight Control 32
- Shadow Control 35

< Taking Photographs (III) >

— Flash Photography —

- Taking OTF Auto Flash Photographs 39
- Taking Daylight Synchro-Flash Photographs (Super FP Flash Mode) 42

< Taking Photographs (IV) >

— Other Operations —

- Exposure Compensation in the OTF Auto Flash Mode 45
- Bulb Exposure 46
- Using the Viewfinder Illuminator 47
- Changing the Focusing Screen 48
- Changing the Camera Back 49
- Attaching the Grip 50

TABLE OF CONTENTS

< For Your Creative Photography >

• The Fascinating Results of Creative Exposure and High-Speed Synchronization	53
• Center-Weighted Average Light Metering	55
• OTF Auto Light Metering	56
• SPOT Metering (1).....	57
• SPOT Metering (2).....	58
• Shooting with One-Point Spot Metering.....	61
• Shooting with Multi-Spot Metering	63
• Sophisticated Multi-Spot Metering	65
• Highlight Control	67
• Shadow Control	69
• Viewfinder Information	71
• Exposure Compensation	72
• Depth of Field	72
• Depth of Field Scale	73
• Preview Button.....	74
• Shutter Speeds	75
• Bulb Exposure	76
• Multiple Exposures	77
• Infrared Photography	77

< OM SYSTEM >

• Flash Photography.....	79
• OTF Auto Flash	80
• Operation of T-Series Flash.....	80
• Main Specifications of T-Series Flash	81
• Main Specifications of F280.....	82
• Using Electronic Flashes Other than the T-Series Flash Units	82
• Bounce Flash.....	83
• Shooting with a Motor Drive.....	85
• Motor Drive Group	86
• Recordata Back 4	87
• Macrophotography.....	88
• Chart of Photographic Ranges	89
• Macro Photo Units	90
• Finder Group Units	92
• Selection of Filters	95
• Handling Care	97
• Questions and Answers.....	99
• Description of Controls	104
• Specifications.....	108

OM-3 Ti

< Preparations before Taking Pictures >

Dioptric Correction

The OM-3Ti permits dioptric adjustment according to your eyesight.



1 Remove the body cap.

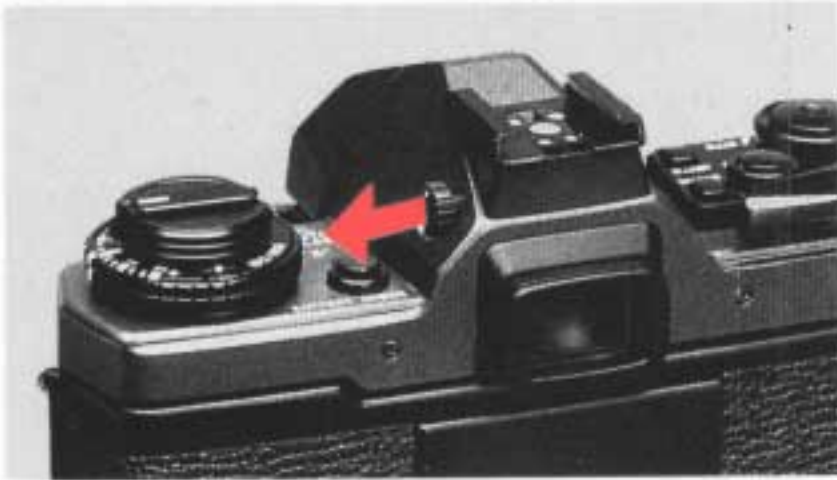

2 Pull out the diopter adjustment knob.

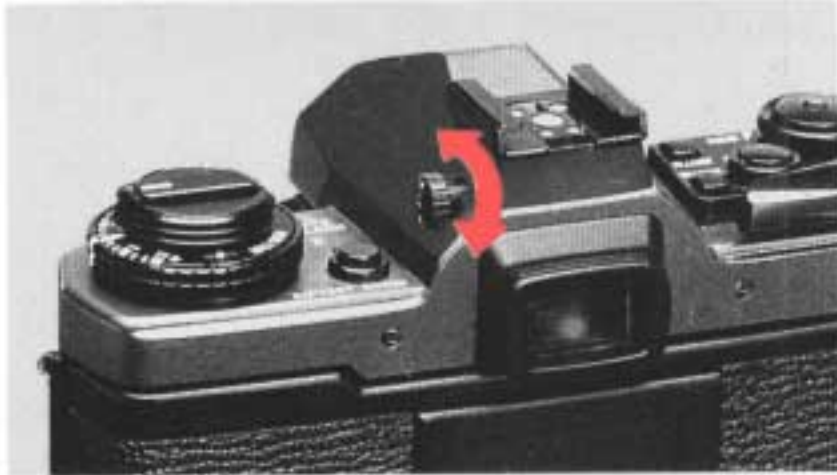

3 Turn and adjust the knob so that the matscreen appears sharp.

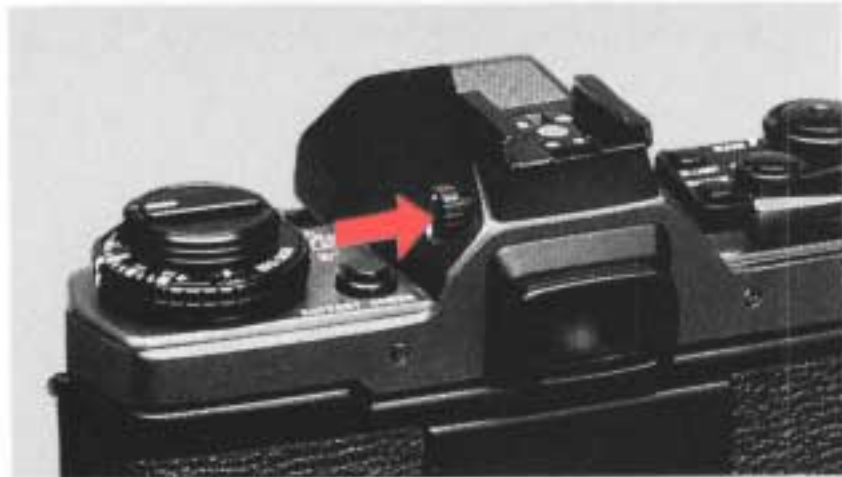
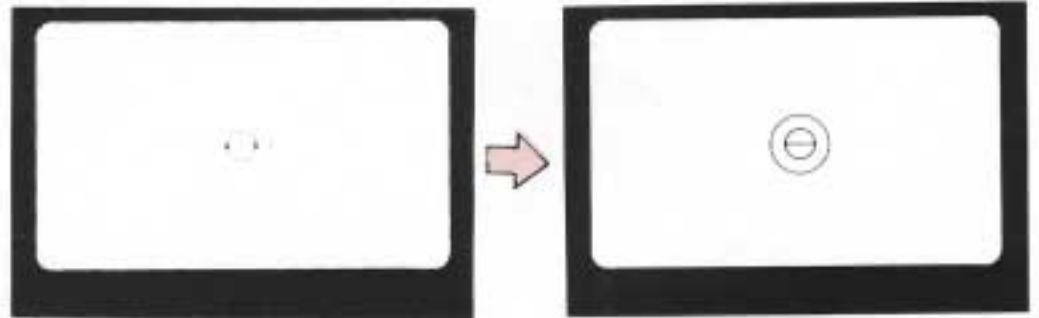

4 Push the knob back in until it locks.

Mounting the Lens



1 Remove the rear lens cap.



2 Align the red dots and rotate the lens clockwise until it locks.



3 Remove the front lens cap. (Press in the mount tabs on the edges of the lens cap parallel with "OLYMPUS").

Removing the Lens



Press the lens release button and turn the lens counter-clockwise.

Mounting of a third-party lens can damage the automatic clear button. This disables the spot function.

Loading the Batteries

Do not use different types of batteries or new and old batteries at the same time. If you are not likely to use the camera for a long period of time, remove the batteries before putting it away.

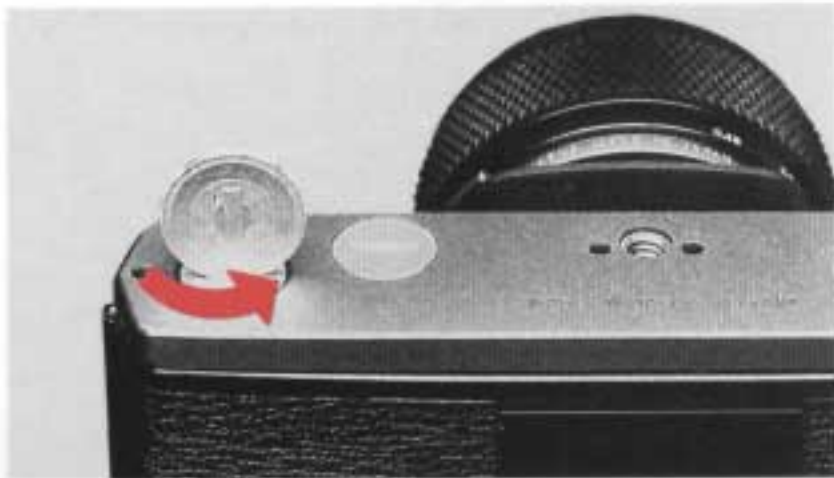

1 Remove the battery cover.

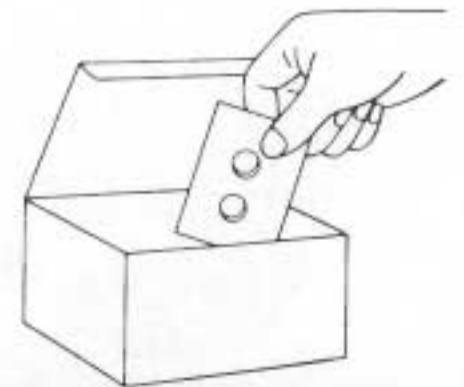

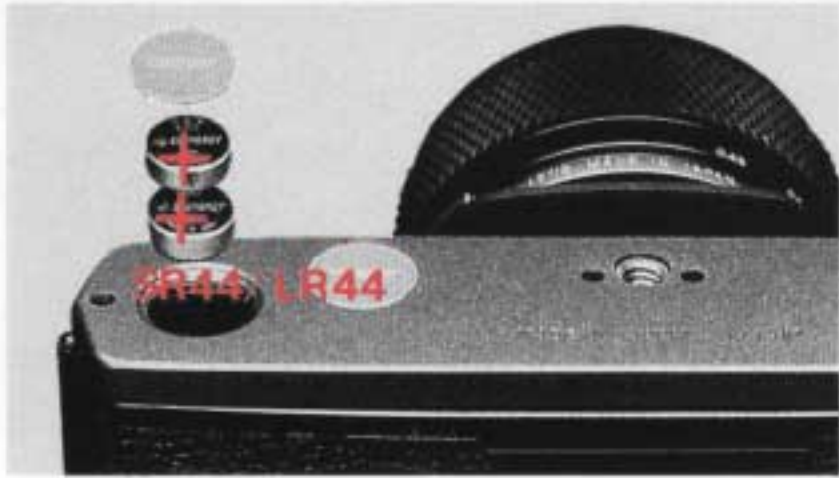

2 Wipe battery surfaces clean. Make sure that + signs are facing upwards.



Use two SR44 silver oxide or LR44 alkaline manganese batteries or one CR-1/3N lithium battery.

Checking the Batteries

Always check the batteries after inserting new batteries, when shooting in cold weather, or if the camera has not been used for a long time.

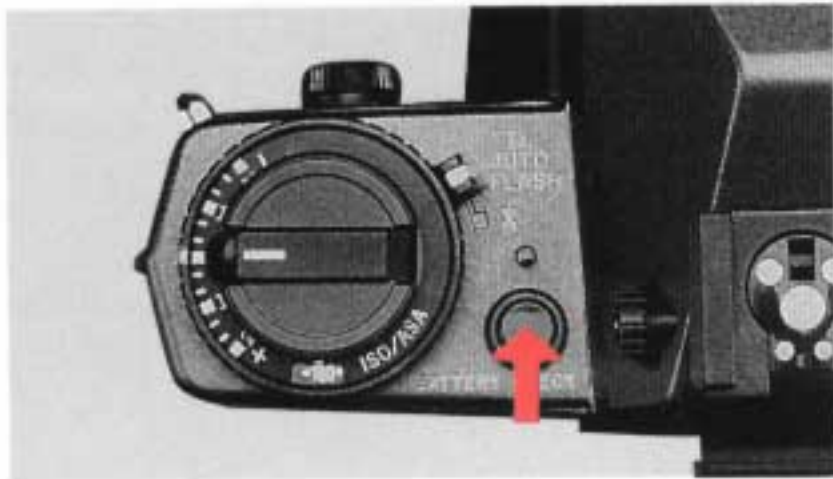

1

Press the BATTERY CHECK button.



2 The battery check indicator lights and the camera beeps to tell you that the batteries have enough power. As the battery power weakens, the signals will become intermittent then vanish completely when they are exhausted.

Loading the Film



- 1** Pull up on the rewind knob to open the camera back.
Tear off the top of the film box and insert it into the memo holder. It will remind you which film you are using.

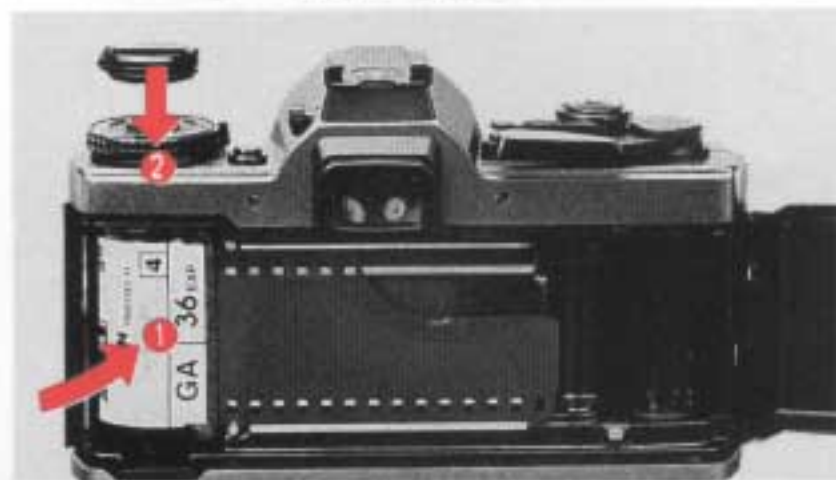
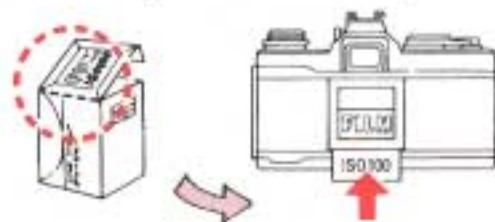

- 2** Insert the cartridge and push down the film rewind knob. (Always load the film in the shade.)



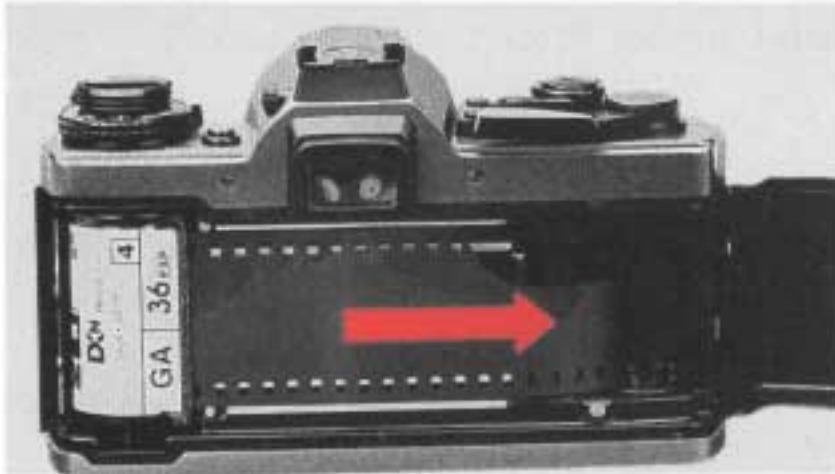

3 Insert the film leader into the take-up spool.

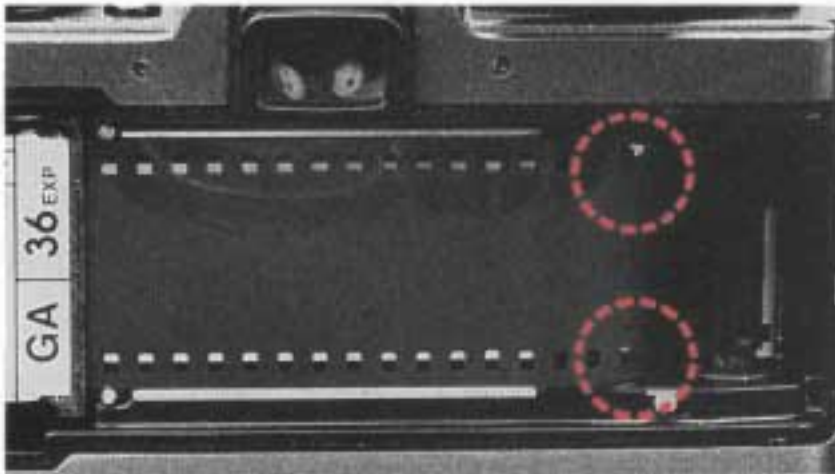
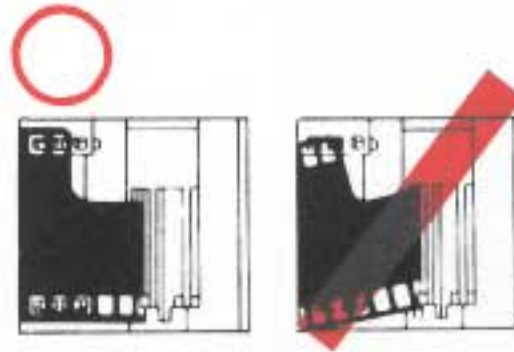

4 Wind the film and make sure the sprocket teeth catch both the upper and lower film perforations.

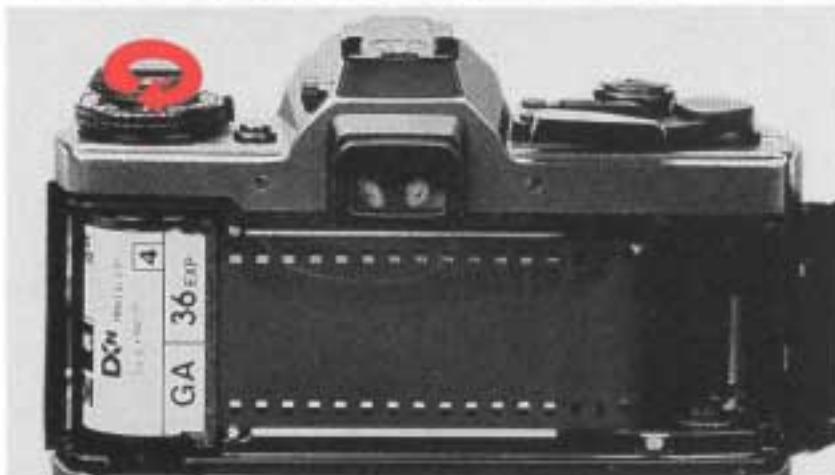

5 Take up the slack by turning the rewind crank clockwise.



6 Close the camera back until it clicks into place.

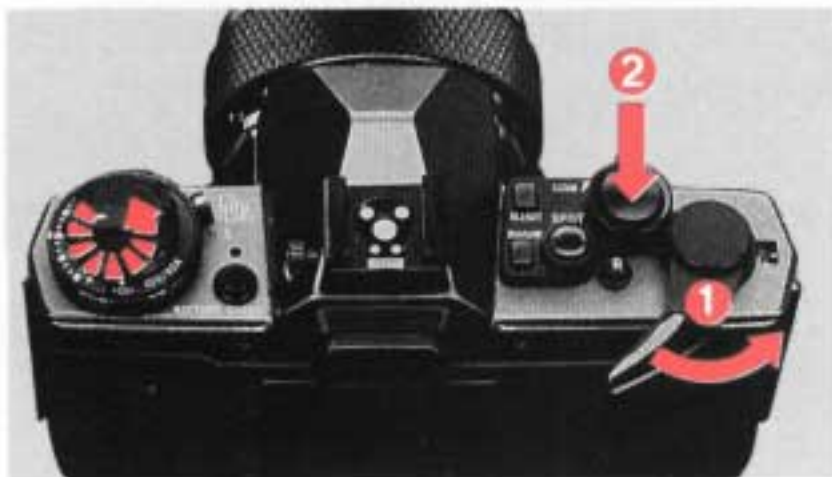

7 Face the camera toward light and take two blind shots. This will bring the film to the first frame.

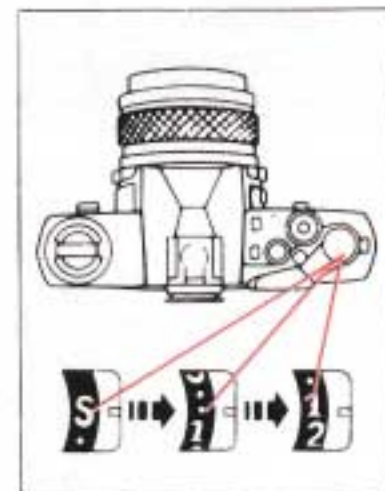

Setting the ISO Film Speed

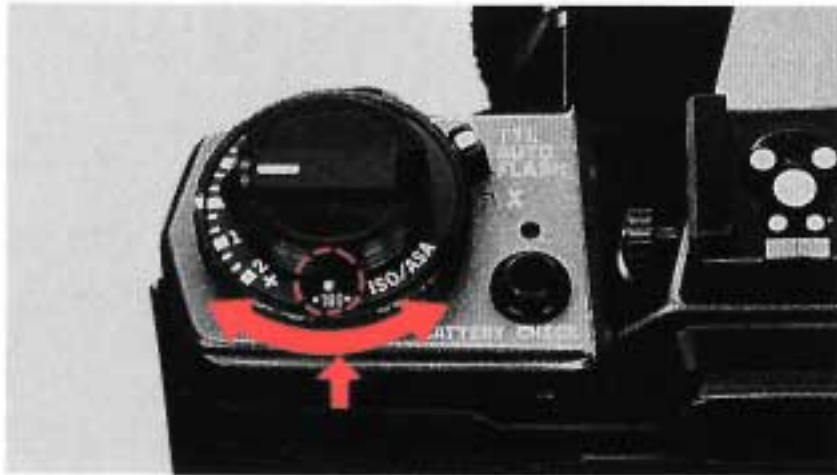

- 1 Lift up the outer collar and rotate until the ISO speed appears in the window.

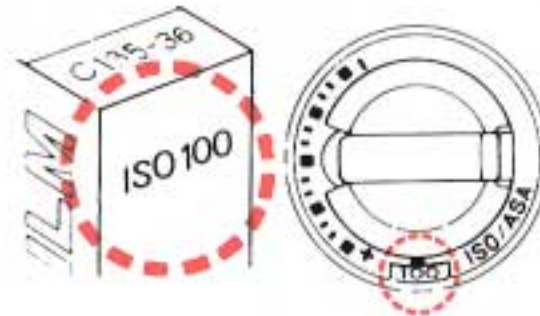

Film speed

(8) (16) (32) (80) (160) (320) (640) (1250) (2500)
6 12 25 40 64 100 200 400 800 1600 3200
(10) (20) (50) (125) (250) (500) (1000) (2000)

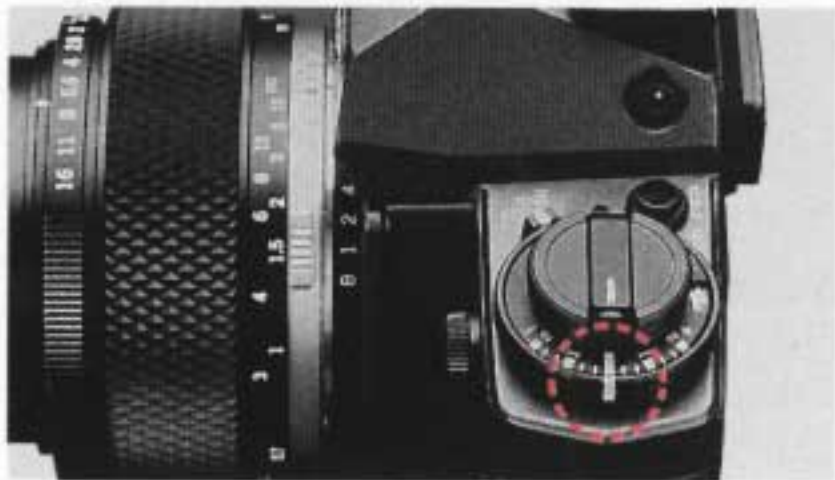

2 Align the exposure line A with the index B.

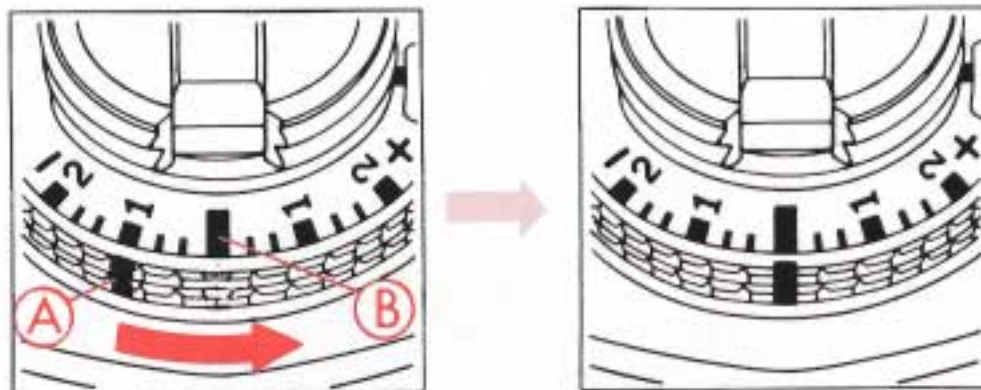

If the exposure compensation dial does not turn to the desired ISO number, set it once at an intermediate value then repeat the procedure.

OM-3Ti

< Taking Photographs (I) > — Center-Weighted Average Light Metering —

The OM-3Ti's exposure mode employs center-weighted average light metering. This meets a wide range of shooting requirements.

Center-Weighted Average Light Metering



1

Press the shutter release lightly to activate the viewfinder display.

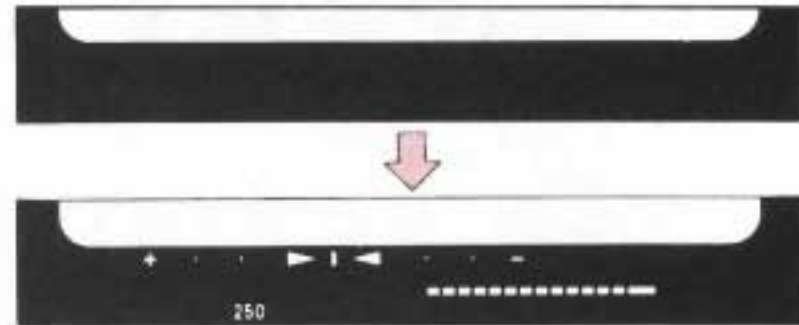

2

Focus on your subject.

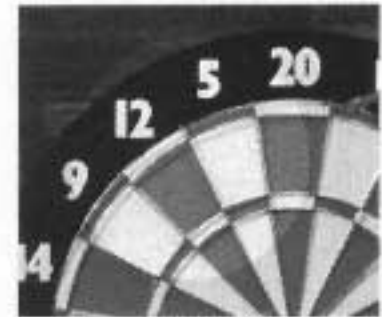



3

Set the bar graph tip to the fixed point between the arrows by adjusting the aperture and/or shutter speed rings

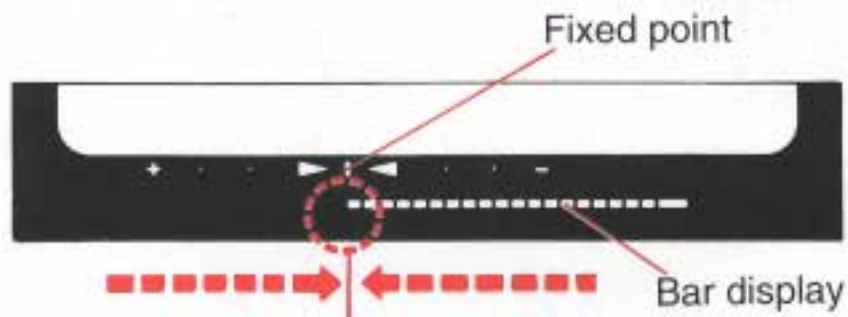

4

The shutter speed you have set will be displayed in the viewfinder.



5

Compose the shot and press the shutter release.



When the subject is too bright, select a faster shutter speed.

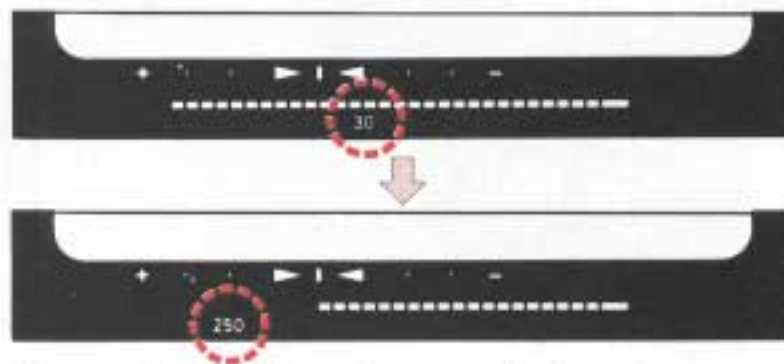

When the subject is too dark, select a slower shutter speed.

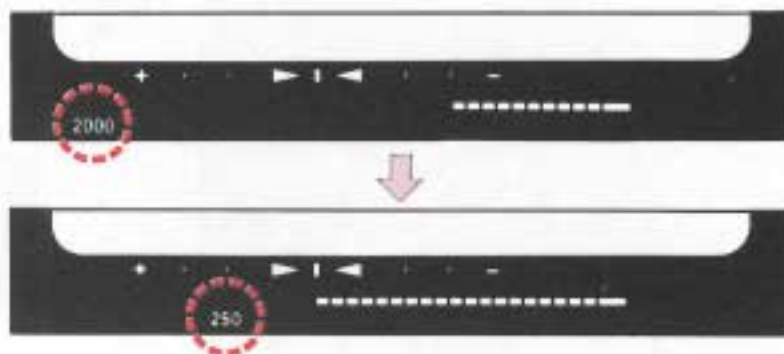

The viewfinder display will go out after about 60 seconds. To turn the display back on again, touch the shutter release button lightly.

Rewinding the Film



1 When the exposure counter indicates the end of your roll of film.

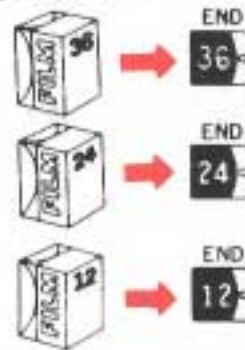

2 Push the "R" Rewind Release Button.

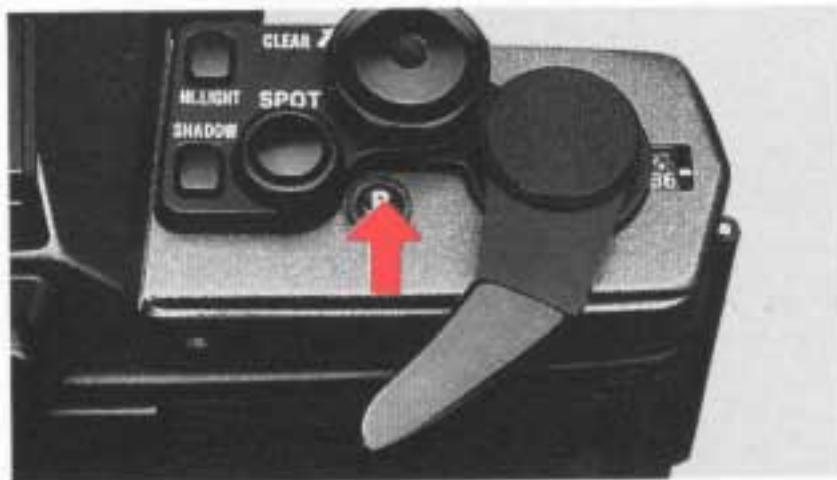

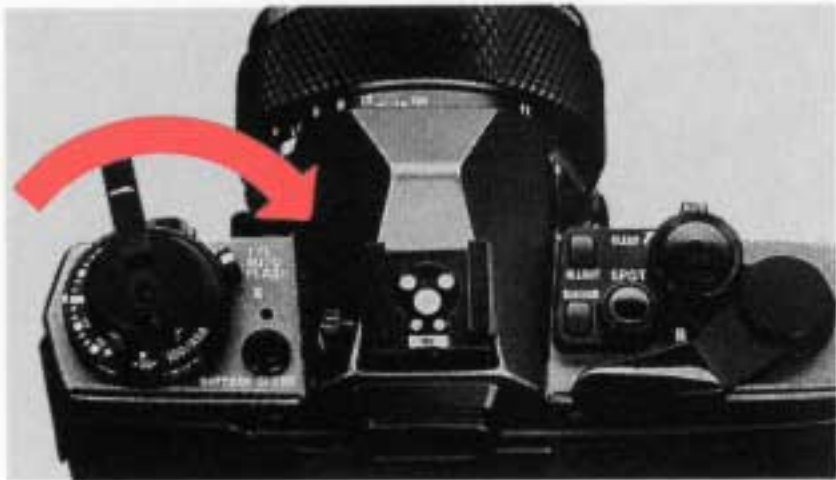

3 Fold out the rewind crank and wind it until the film tension is released.

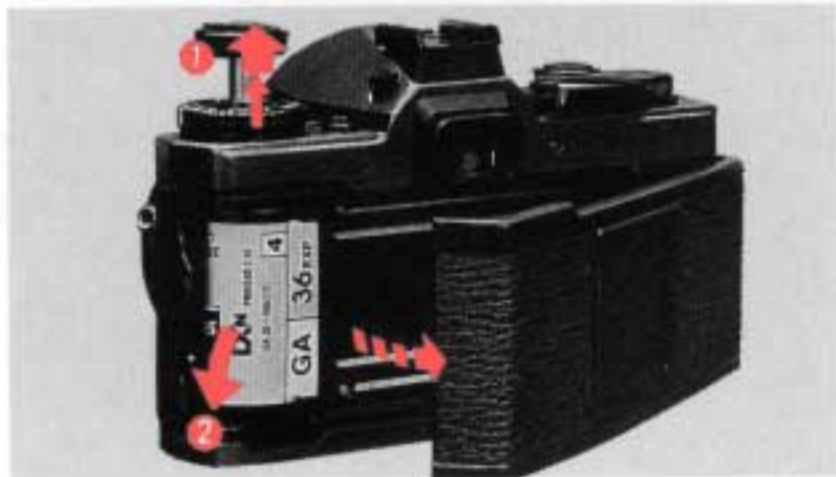

4 Open the camera back by pulling up on the rewind knob and remove the film.

OM-3Ti

< Taking Photographs (II) > — Spot Metering —

The spot metering system of the OM-3Ti enables you to control the exposure as you like. It insures perfect exposure of backlighted and high-contrast subjects and expands shooting possibilities for more creative photography.

How to Use Spot Metering

Reference
P 57–62



- 1 Align the microprism area with the area you want to measure. (The spot metering range is outlined by the outer edge of the microprism.)

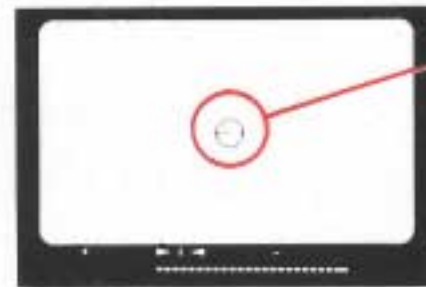

Spot metering range



2 Press the spot button to take a meter reading. You will hear an electronic sound and the word "SPOT" will appear in the viewfinder. The metered value is displayed by the "◇" mark.



If you move the camera, another "◇" mark will indicate the exposure value in the center of the frame along with the spot metered value.



3 Set the bar graph tip to the fixed point between the arrows by adjusting the aperture and/or shutter speed rings.

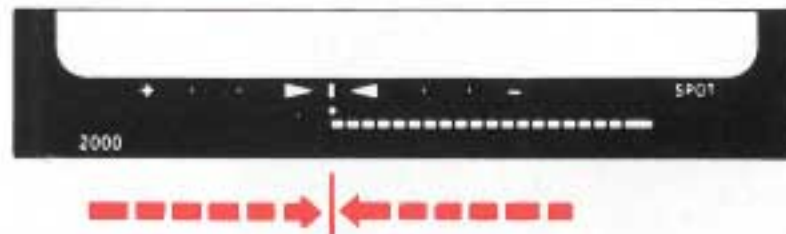

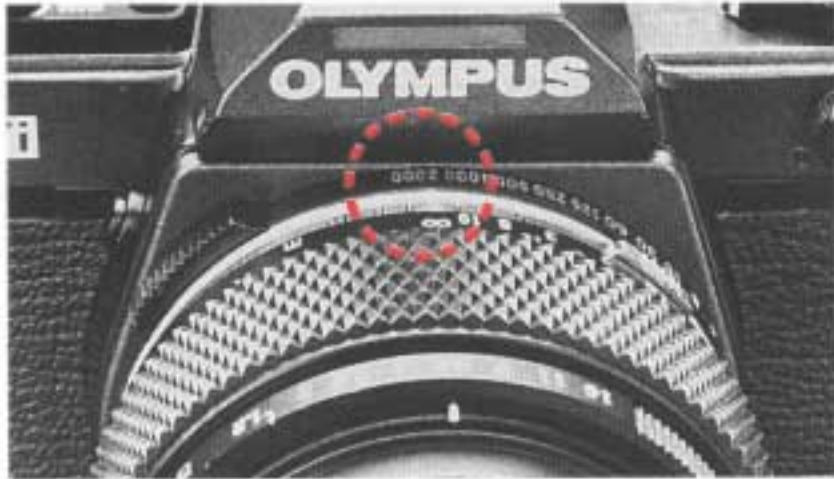

4 The shutter speed you have set will be displayed in the viewfinder.

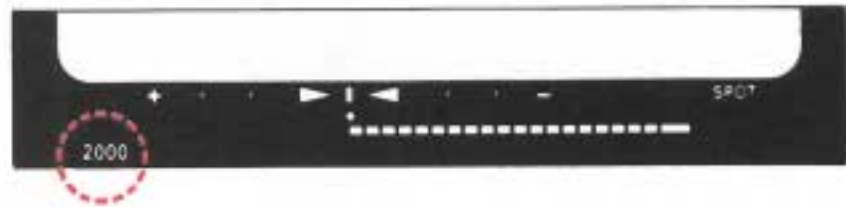

5 Press the shutter release to take the picture.



6 The subject will turn out correctly exposed, regardless of the brightness of the background.

The spot metering mode is automatically canceled after the shutter releases or when 60 seconds has passed since it was engaged. Center-weighted average metering will be restored.

How to Clear Spot Metering



- 1 Set the lever to CLEAR. "SPOT" and "◇" mark will disappear and the mode will return to center-weighted average metering.



How to Use the Multi-Spot Metering

Spot metering is possible in up to 8 spots.

Reference
P 63–66



This sample photo shows a backlighting subject.



1 Take spot metering on the face (first spot).

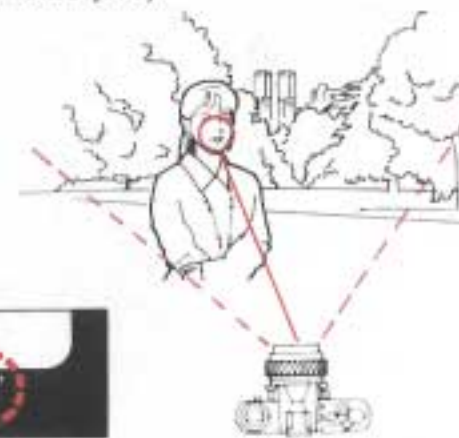

2 Take spot metering on the lawn (second spot).



3 Take spot metering on the building in the background (third spot).

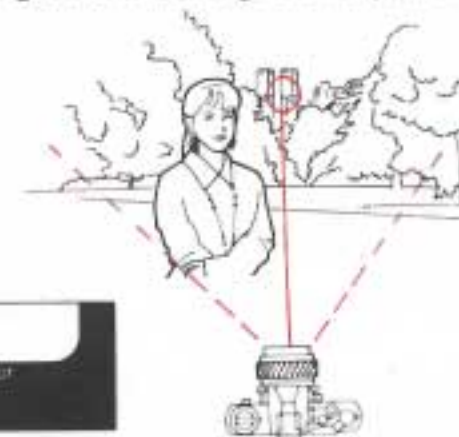



4 Set the bar graph tip to the fixed point between the arrows by adjusting the aperture and/or shutter speed rings.

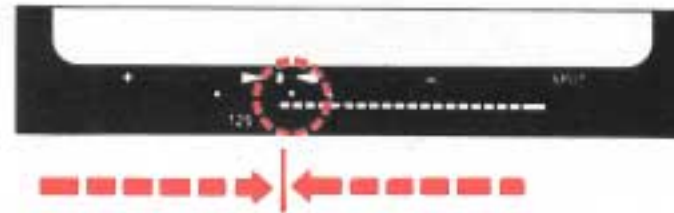

5 Compose your picture and press the shutter release.

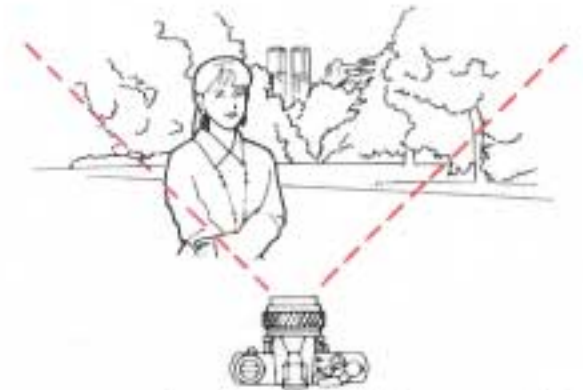

Exposure is achieved by averaging the brightness of the three metered points.

To cancel the metered value, operate the clear lever.



Highlight Control

If you want to render white objects as white . . .

Reference
P 67-68

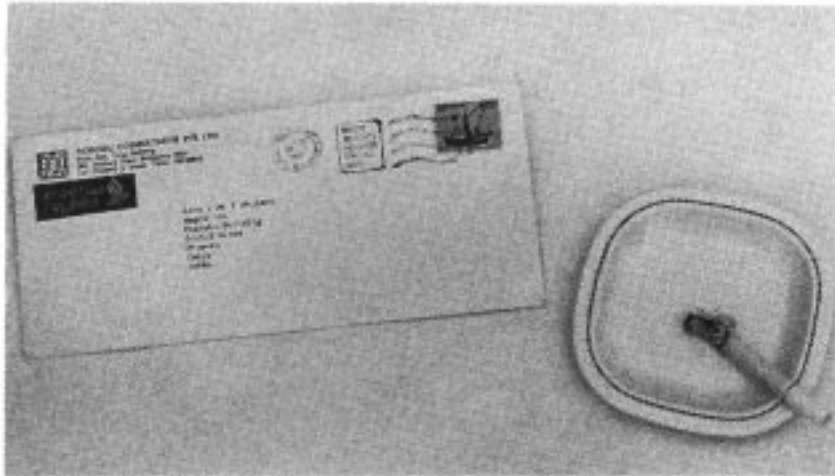

In ordinary shooting, white objects will turn out grayish if the picture is taken in strong brightness over the entire frame.



1 Take spot metering on the part of the subject which you want to render in white.



2 Press the HI.LIGHT button.

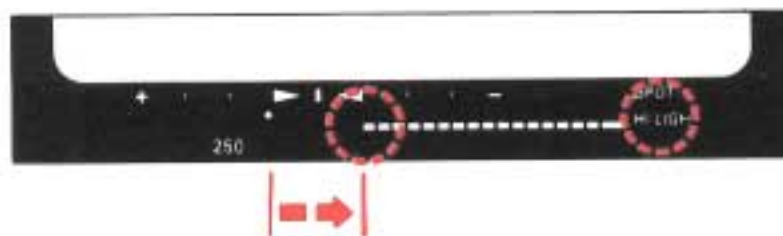

The bar display shows 2-step automatic compensation.



3 Set the bar graph tip to the fixed point between the arrows by adjusting the aperture and/or shutter speed rings.

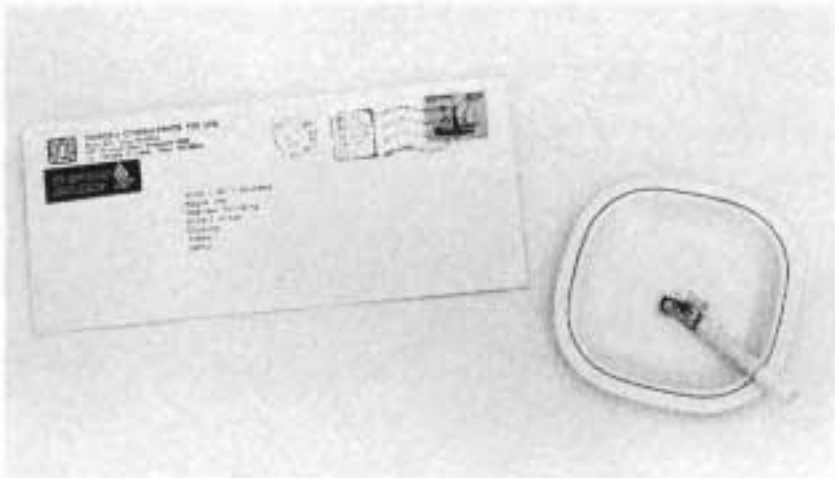
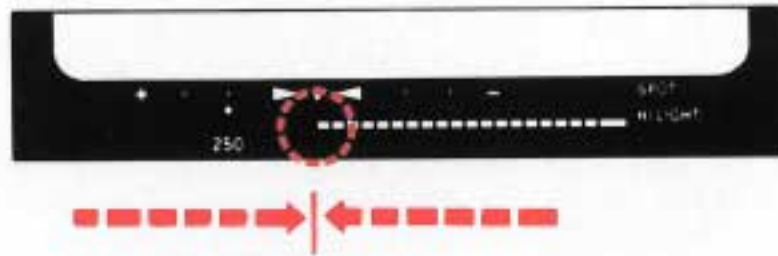

4 Press the shutter release. Exposure is automatically corrected to give 2-step overexposure, ensuring that white objects turn out white.

The highlight control is cleared by pressing the HI.LIGHT button once again. To cancel the metered value, use the clear lever.

Shadow Control

If you want to render black objects in black...

Reference
P 69–70



In ordinary shooting, black objects will turn out grayish if it is very dark over the entire picture frame.



1 Take spot metering on the spot which you want to render in black.



2 Press the SHADOW button.

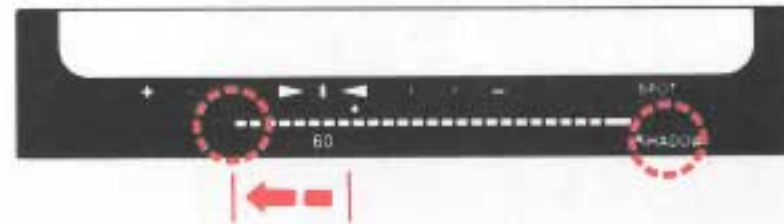

The bar display shows $2\frac{2}{3}$ -step automatic compensation.



3 Set the bar graph tip to the fixed point between the arrows by adjusting the aperture and/or shutter speed rings.

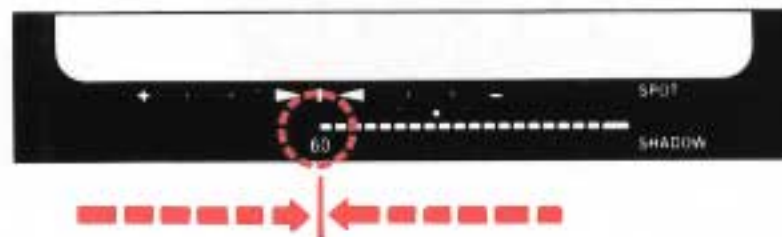

4 Press the shutter release. Exposure is automatically corrected to give $2^{2/3}$ -step underexposure, ensuring that black objects turn out black.

The shadow control is cleared by pressing the SHADOW button once again. To cancel the metered value, use the clear lever.

OM-3 Ti

< Taking Photographs (III) >
— Flash Photography —

Taking OTF Auto Flash Photographs

The following describes flash operation procedure when using a T-Series flash.

Reference
P 79-84

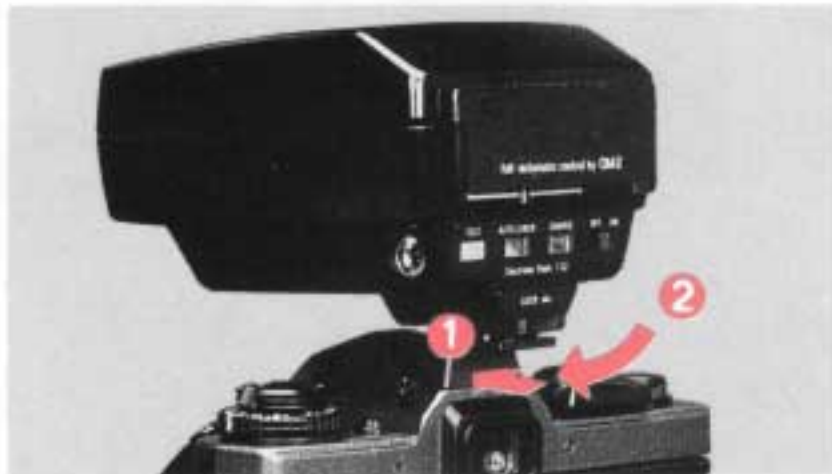

1

Slide a T-Series flash into the accessory shoe and secure it with the lock screw.

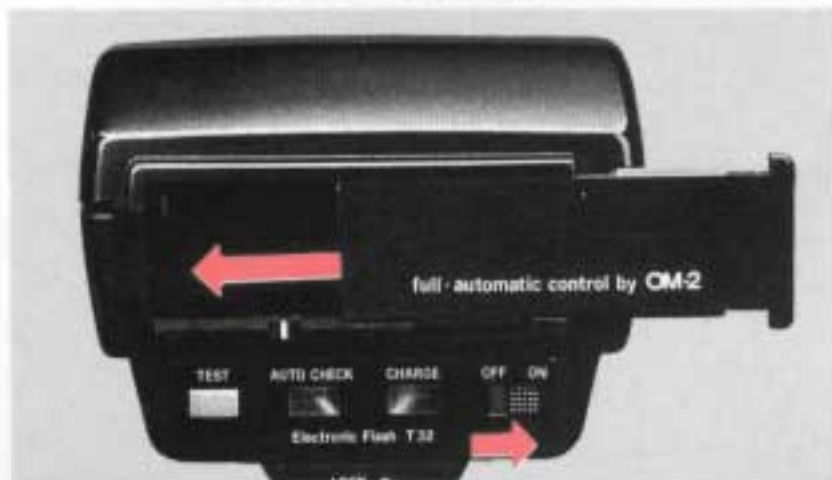

2

Mount the provided chart on the back of the flash and switch on its power.



3

Check the indicator.

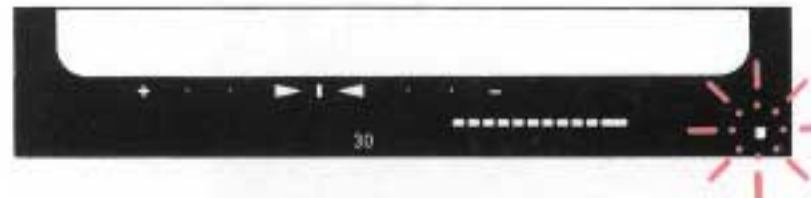

4

Set the flash mode to TTL AUTO FLASH to take OTF auto flash photographs. (TTL auto flash and OTF auto flash are the same function.)

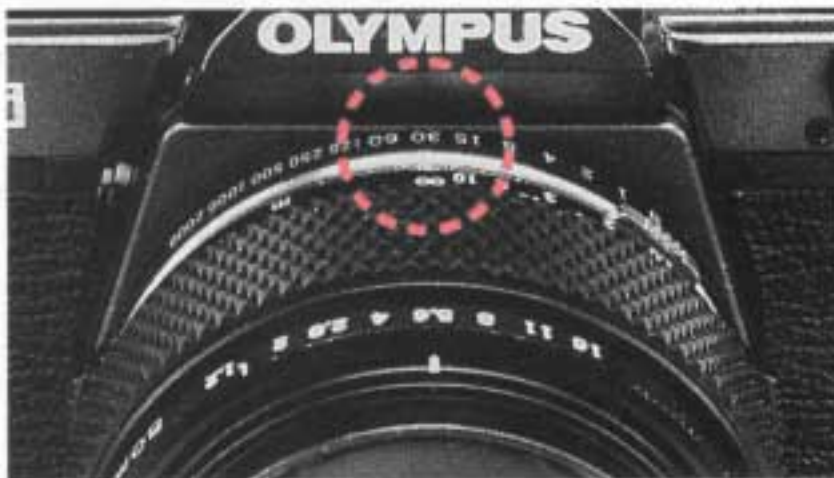

5

Select a shutter speed. The flash synchronization range is B.1~1/60-sec.



6 Select an aperture.



7 Press the shutter release.



8 Check the green LED in the viewfinder. If it blinks, the photograph has been shot with correct exposure. If it is off, flash strength was insufficient.



Taking Daylight Synchro-Flash Photographs (Super FP Flash Mode)

The following describes flash operation procedure when using the F280. For OTF Auto using the Normal OTF Flash mode, refer to the F280 instruction manual.

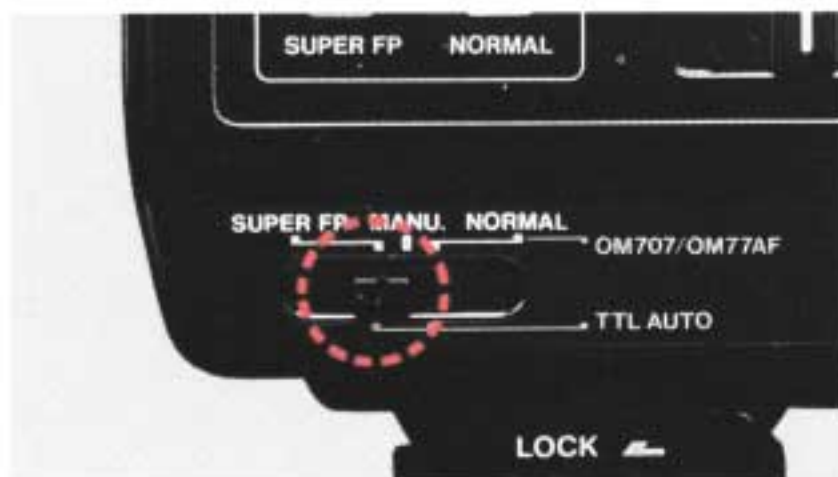

1

Set the F280's mode to SUPER FP.



2

Set the flash mode selector lever to TTL AUTO FLASH or X.

Either mode can be used in the Super FP Flash mode.

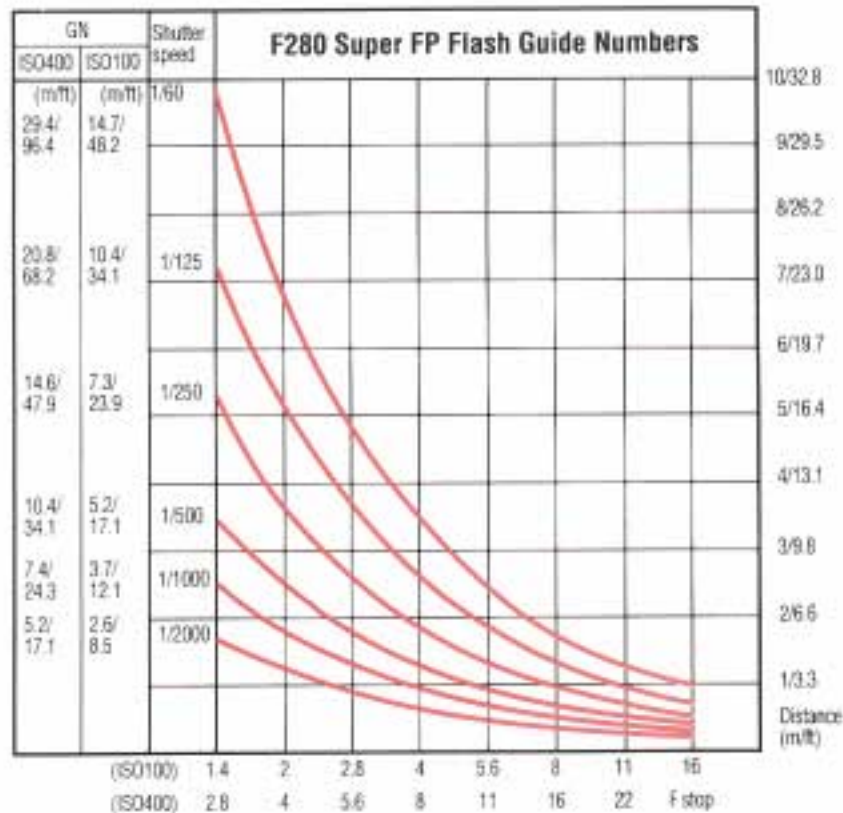

3

Select a shutter speed between 1/2000 and 1/60 sec. and aperture according to the chart on the left.

Data shown on this chart is based on situations where there is no natural lighting; the actual setting may differ depending on shooting conditions.

4

Press the shutter release and confirm correct exposure by checking the indicator on the flash. (There is no exposure confirmation display shown in the viewfinder.)

At temperatures under -10°C (14°F) uneven exposure may sometimes occur due to temporary degradation of Super FP Flash function.



OM-3 Ti

< Taking Photographs (IV) >
— Other Operations —

Exposure Compensation in the OTF Auto Flash Mode

Reference
P 72

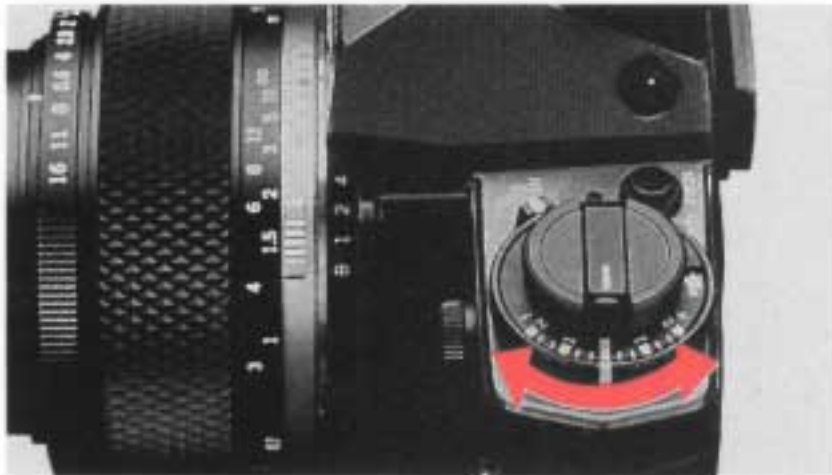

1 When an exposure compensation is set, the indicator blinks in the viewfinder.

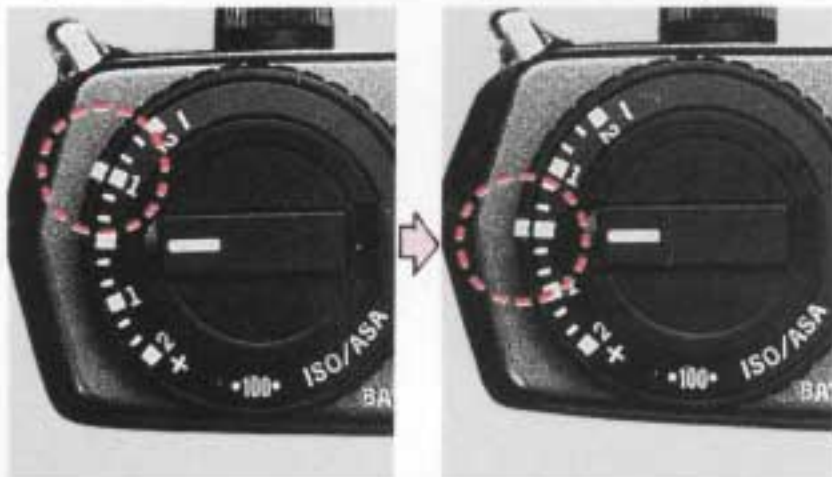
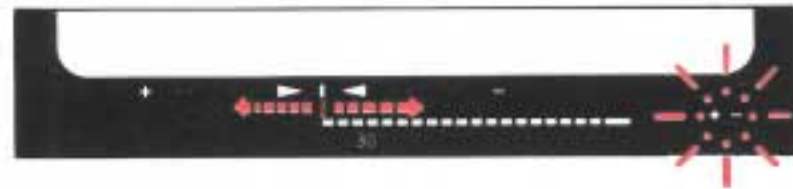

2 After shooting, return the dial to its original position.

Bulb Exposure

Reference
P 76



1 Turn and set the shutter speed dial to "B".

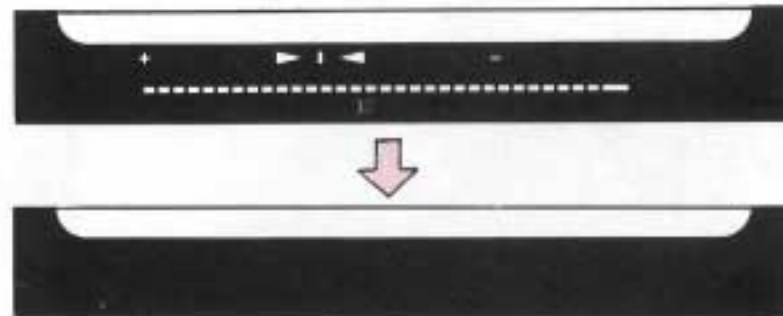

The display in the viewfinder disappears.



2 The shutter will remain open as long as the shutter release button is held depressed.

Using the Viewfinder Illuminator



- 1 Push the viewfinder illumination button if the viewfinder display is too dark to read.

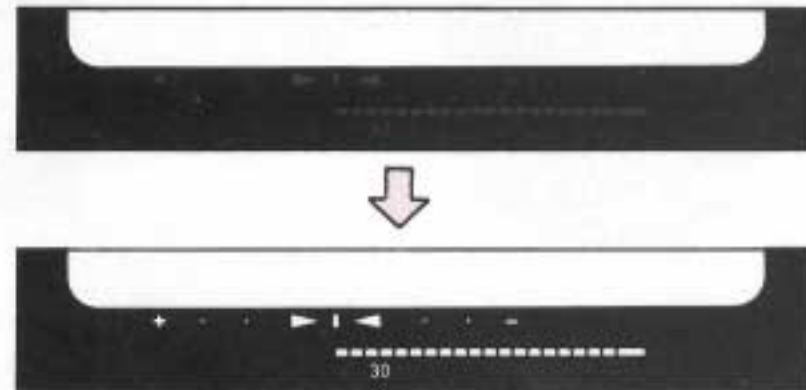

The illuminator will shut off after 10 sec.

Changing the Focusing Screen

Reference
P 92-94

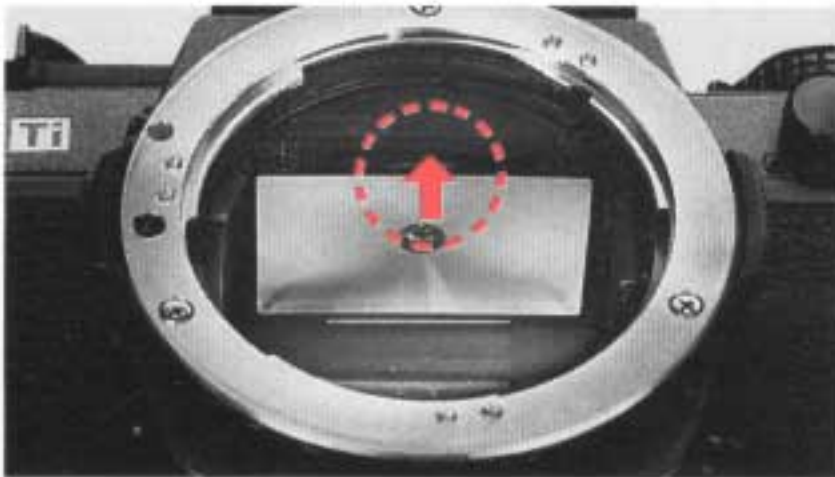

- 1** Pull down the screen frame.
Pull the lug at top inside the body mount toward you to swing down the screen frame.

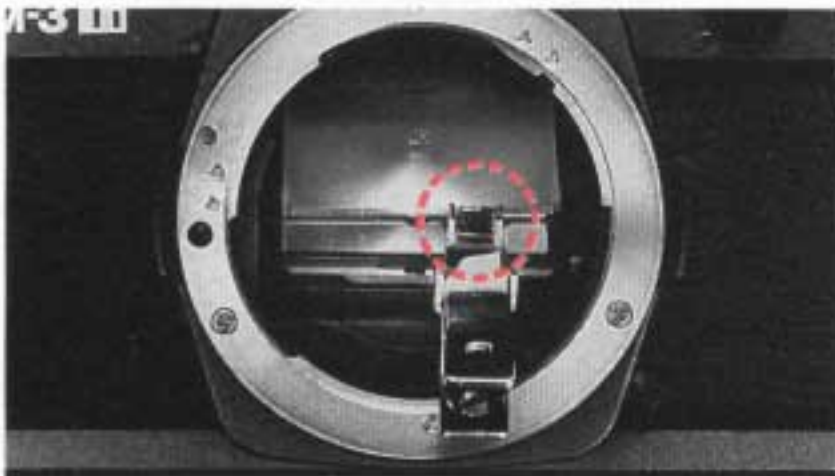

- 2** To change the focusing screen, use the tweezers supplied with an optional focusing screen. Push the frame upward until you hear a click.

Changing the Camera Back

The camera back is interchangeable with the Recordata Back 4.

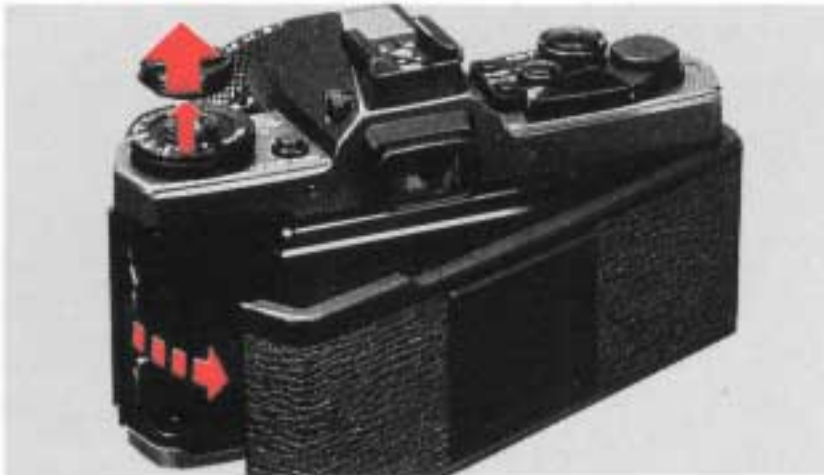

- 1 Open the camera back. Press down on the camera back release button and remove the camera back.



Removing

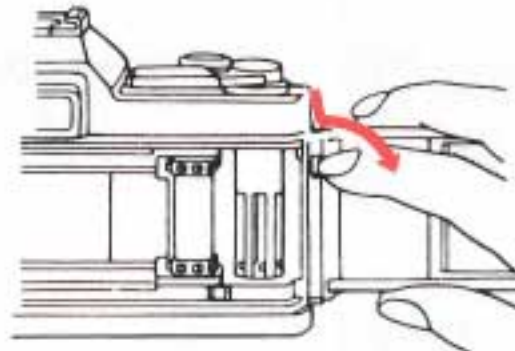

Attaching

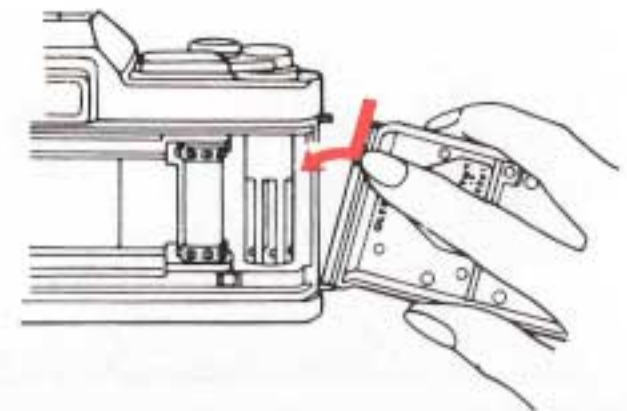

Attaching the Grip

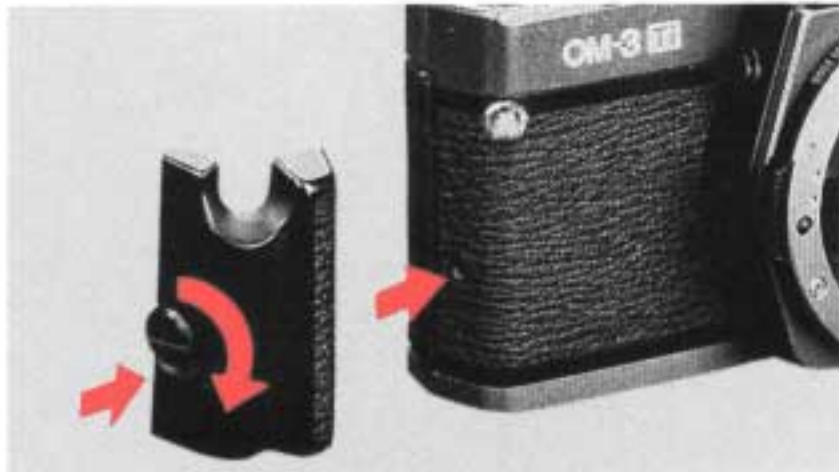

1

Attach the provided Camera Grip.

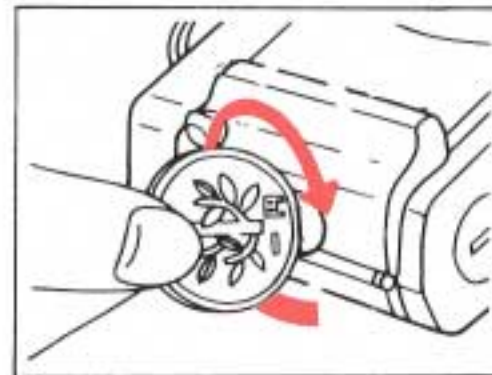

When using a motor drive or winder, detach the Grip.



OM-3 Ti

< For Your Creative Photography >

THE FASCINATING RESULTS OF CREATIVE EXPOSURE AND HIGH-SPEED SYNCHRONIZATION

By Akio Kojima

Have you always been satisfied with the resulting images when using the camera's meter or an automatic exposure system?

Chances are, most of the time you've been happy with the results. Occasionally, however, you may have been disappointed by photographs that didn't turn out as expected, especially shots with backlighting or other special lighting conditions, or those shots where you tried to capture a particular mood or express your own creativity.

Color reversal films, in particular, allow for only a narrow latitude of exposure so that in many cases satisfactory results are not obtained with simple automatic exposure. Generally speaking, the results given by a camera's light meter represent exposure values obtained by a metering system that has been specifically adopted for that camera. They do not always represent data as the result of analytical measurement of various conditions such as the subject's brightness range and distribution as well as contrast. In actual shooting conditions, however, there is often a very wide brightness range (luminance range) — from the brightest spot to the darkest spot in a picture. In some landscapes, for example, there can be a difference of as much as 8 exposure values (EV) in the brightness range of an image, representing a brightness/darkness ratio of more than 1 : 200. The subject brightness range

that a film can reproduce (or an effective exposure range of a film) is limited to about 4 ~ 5 EV. Therefore, in many cases it is impossible to accurately reproduce the subject in its entire range on film.

The automatic exposure system (AE) on ordinary cameras generally selects exposure using an exposure meter in combination with the film speed. However, if photography is to be a means of communication, the photographer must control the tone of the picture in order to most effectively emphasize the mood and expression of the subject. To do this, it is necessary to choose the exact spot on which you want to emphasize the desired tone and match this spot to the effective exposure range of a film.

To meet such exposure requirements, the following three types of exposure are available.

Center-based exposure is the most commonly used type of exposure. By matching the center of the subject's brightness range to the center of the film's exposure range, the subject is reproduced with greater emphasis on the center-measured tone. If the brightness range is greater than the range of the film, the extremes will be ignored.

Shadow-based exposure gives the highest priority to the shadow area in the subject brightness range. The tone in the highlight area that is not covered may be ignored.

Highlight-based exposure, on the contrary, gives the highest priority to the highlight area. This exposure allows the shadow area to come out somewhat darker.

Advanced photographers oriented for creative photography base their exposure selection on these considerations. Measuring the values on several important spots of the image with a hand-held spot meter, they have to take all the troublesome and time-consuming steps necessary to calculate the exposure mentally. If everything goes well, the image will be properly exposed.

The OM-3Ti does all this automatically. Equipped with a spot metering system and built-in computer, it calculates the correct exposure value and frees the photographer from having to make numerous complicated exposure calculations. Now, with the OM-3Ti camera, it's easy for everyone to obtain high-precision, "creative" exposure control.

When combined with a T-Series flash, the OTF direct light metering function offers total control of flash strength, eliminating any bothersome calculation of exposure. When combined with the F280, Super FP flash control is possible with a high speed shutter. This allows for daylight synchro, offering the benefits of flash use in well-lit conditions and daylight synchro shooting of fast-moving subjects. Moreover, because daylight synchro

with a wide open aperture can result in out-of-focus background, the subject can stand out to render a more dramatic or portrait-like effect.

All these flash capabilities are very attractive to photographers engaged in creative activities with 35mm SLRs. Additionally, those flashes with the Super FP mode have a long emission duration which conventional flash units don't have. If this is put to good use, it is possible to create a totally new photographic effect. It all depends on your creativity.

CENTER-WEIGHTED AVERAGE LIGHT METERING

The OM-3Ti uses center-weighted average light metering for its basic light metering system. This system emphasizes measurement of brightness in the center of the screen, rather than averaging measurement of the brightness of the entire screen. Thus, the main subject in the center is unlikely to be insufficiently exposed, even when the background is too bright or too dark. This metering system thereby does an excellent job of handling most ordinary shooting situations — such as

situations when front-lighting and contrast isn't too strong. Since the OM-3Ti has a light-receiving element in an ideal position at the bottom of the mirror box, the amount of light that arrives at the light-receiving element doesn't change even when the focusing screen is replaced. For this reason, the OM-3Ti achieves correct light metering with all focusing screens. Additionally, there is no adverse effect from rear incidence light through the eyepiece.

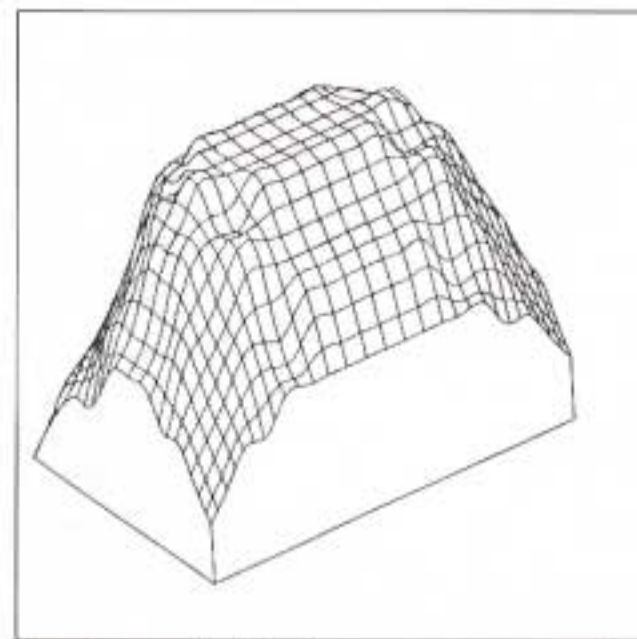
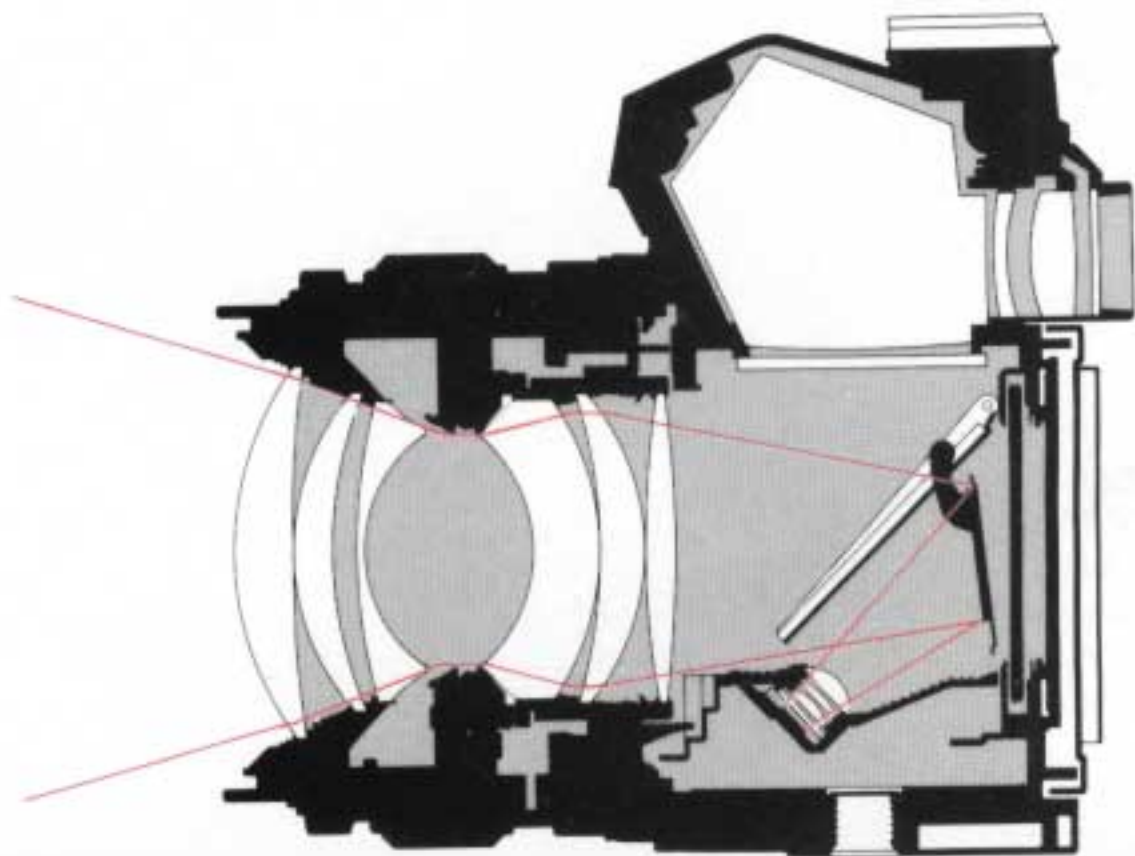

Center-weighted average metering
3-dimensional sensitivity distribution
diagram

OTF AUTO LIGHT METERING

The OM-3Ti has manually selectable shutter speeds. But combined with a T-series flash, the camera also provides full control of flash lighting via OTF auto light metering. This system automatically controls flash intensity while directly metering the flash lighting being exposed on film. For this reason, there is no deviation between the metering area of the flash sensor and the area actually exposed. Moreover, all

aperture settings can be used. So advanced techniques such as multi-flash and bounce-flash are at your command, and are all fully automatic. Moreover, troublesome exposure calculation in macro photography is completely eliminated. Center-weighted average light metering is also used in flash shooting.

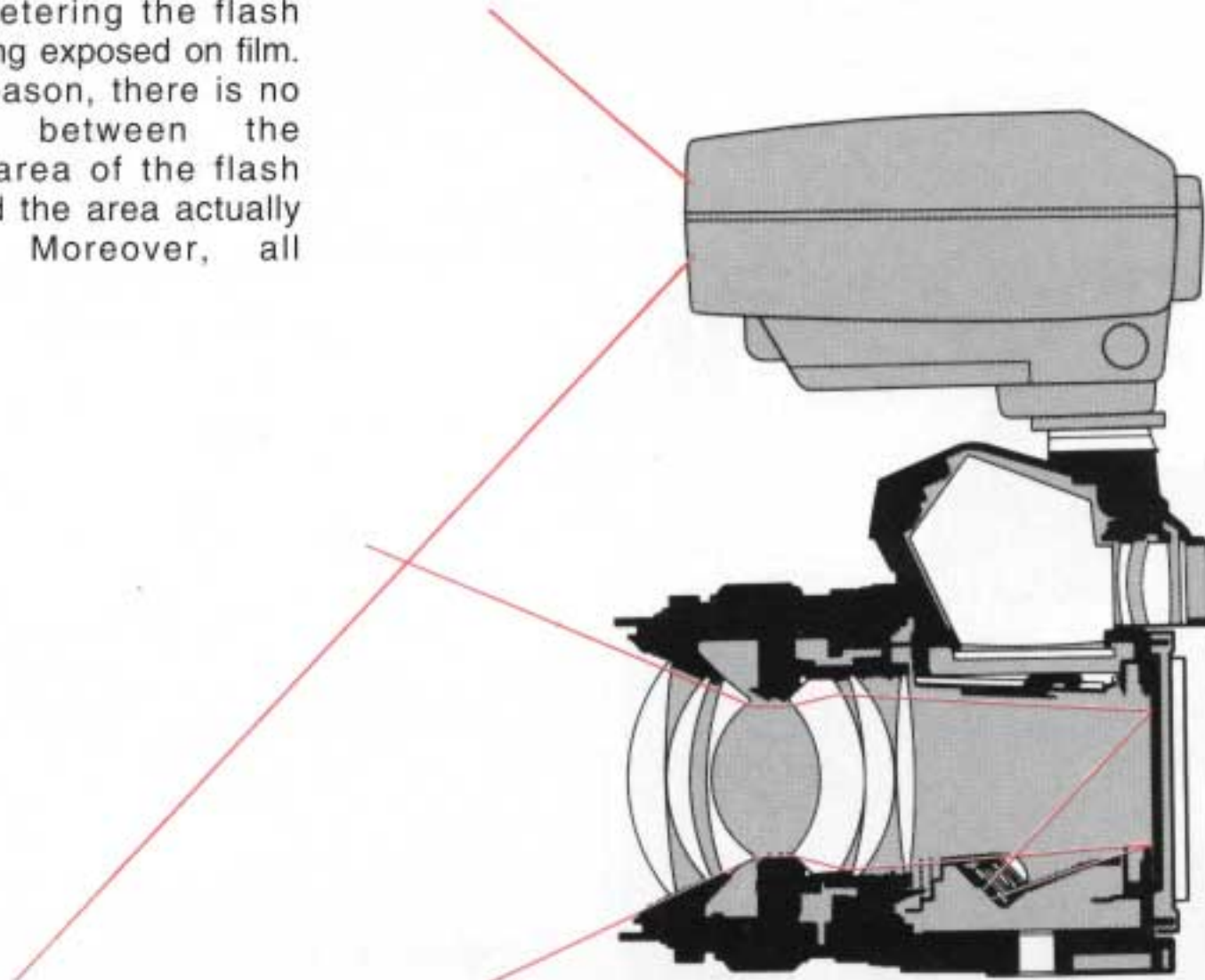

SPOT METERING (1)

This spot metering system measures the brightness of the central spot of the picture frame (2% of the entire frame).

The center-weighted average light metering provides correct exposure for subjects in follow light and in pictures having a nearly uniform brightness throughout the entire frame. Exposure compensation is necessary, however, for backlit subjects and in compositions using special lighting in which there is a difference in brightness between the subject and background. In some cases, it

would also be desirable to express subtle lighting effects according to the photographer's subject motive. To realize such sophisticated expressions, fine metering of various spots on the subject is required. If the "Spot" button of the OM-3Ti is pressed, the metering mode switches to spot metering in which the brightness of the area (corresponding to the microprism section in the center of the viewfinder) is metered and stored in memory. By using this spot metering, photographers can control exposure as desired to realize creative lighting compositions.

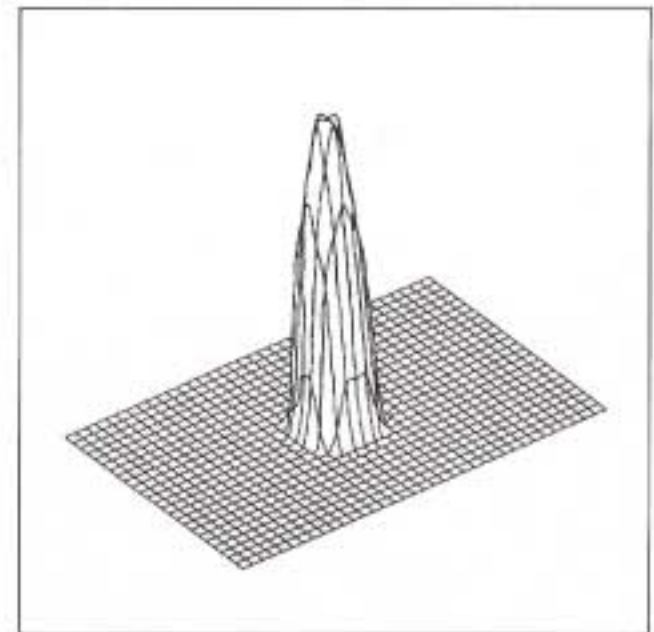
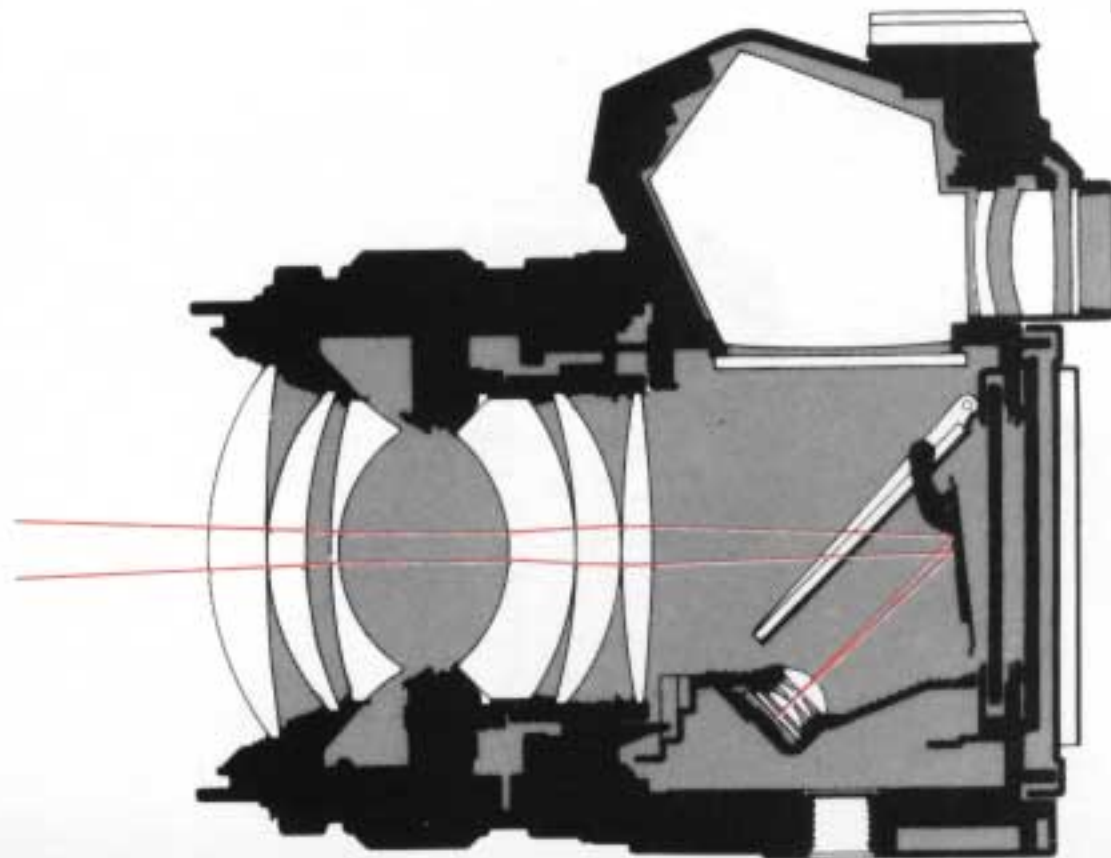

Spot metering 3-dimensional sensitivity distribution diagram

SPOT METERING (2)

To ensure correct operation of the spot metering:

- ① In spot metering, it is necessary to put the area to be metered in the microprism section. If there is a brighter spot in the microprism section, than the intended subject, the metering value will be affected.
- ② If a lens is changed, the light receiving angle for spot metering also changes automatically. The angle is narrower with telephoto lenses, and wider with wide angle lenses. However, the metering area seen in the viewfinder does not change.
- ③ When a zoom lens is used, Spot Metering on the telephoto side permits metering in narrower range and that on the wide angle side in a wider range, thus allowing the users to choose the metering range freely.

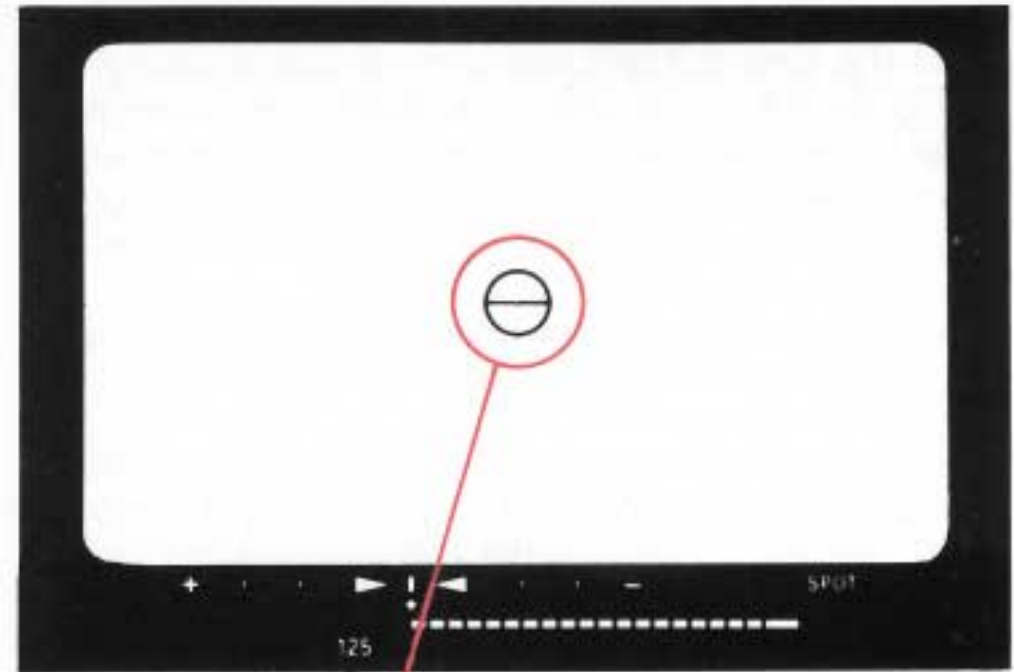

Spot metering area

When you point the camera at the main subject and press the spot button, the camera will measure the brightness of the area where you position the outer edge of the microprism and hold it in memory. This metered value is kept in memory even if the camera angle is changed afterwards. So you can recompose the shot in whatever way you want.

Exposure selection can be achieved by simple operation of the aperture and shutter speed rings after choosing your favorite composition.

After the shot, spot metering is automatically disengaged and center-weighted average light metering is restored. When you want to cancel the input value immediately, operate the clear lever. Even without doing so, input value will automatically be canceled 60 seconds later.

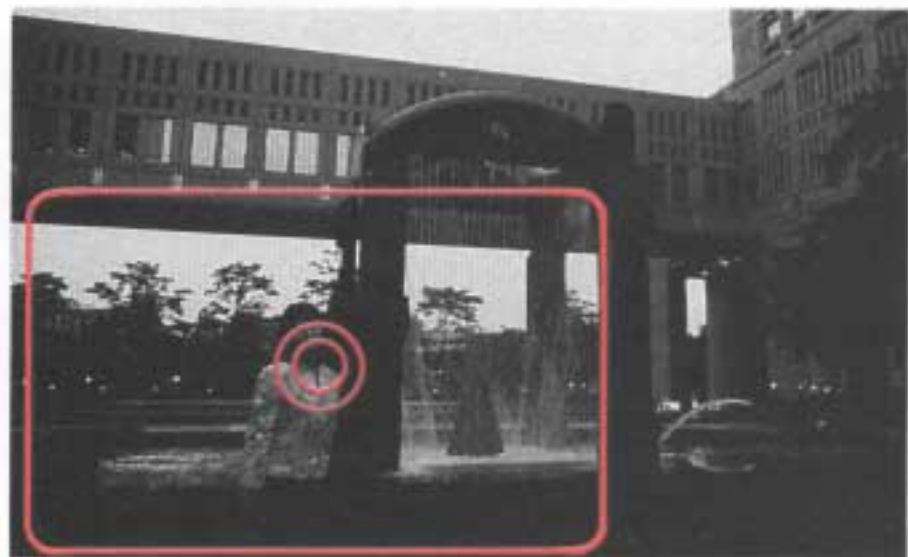

① Spot metering



② Framing



SHOOTING WITH ONE-POINT SPOT METERING



This is partial metering of only one point on the picture frame. Correct exposure is obtained by simply pressing the spot button. We will give a simple example to explain when one-point spot metering is used. If a backlit girl is exposed on averaged light metering, the expressions in her face will not be clear because it comes out entirely underexposed under the effect of sunlight. For correct exposure of her face, it is recommended to make a one-point spot metering on it. Conventional exposure operations based on the photographer's experiences and guesswork have thus been completely eliminated to



facilitate exposure compensation in backlight. As soon as the spot button is pressed, the brightness of the spot area is locked. So you can frame your picture as you like. To clear the input value, operate the clear lever.



SHOOTING WITH MULTI-SPOT METERING

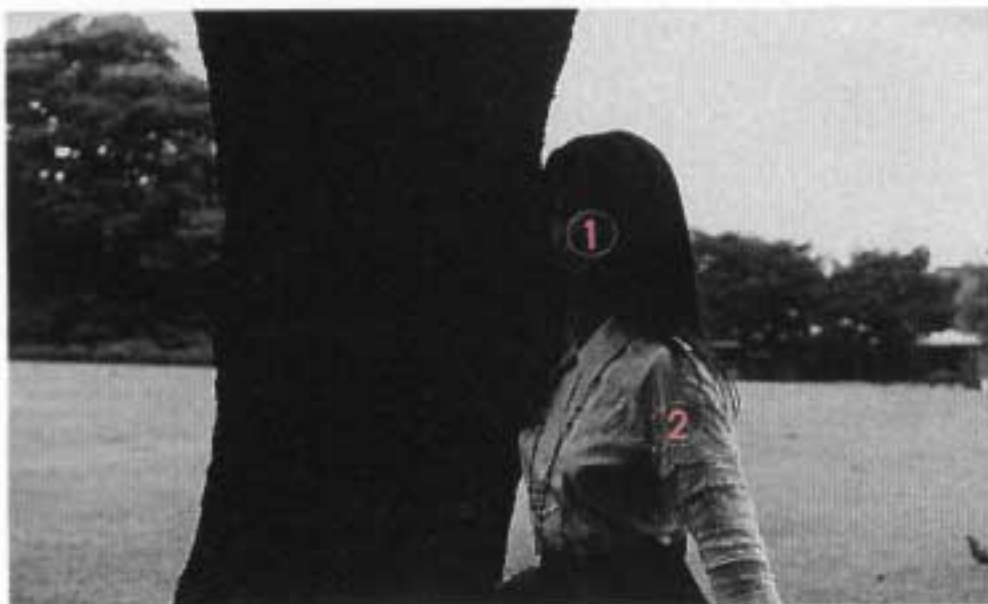

This is a partial metering of two or more spots on the picture frame. It can be used to determine exposure by taking into account various spots that differ in brightness. The picture above shows an example in which the exposure of the background should also be considered while taking care to prevent underexposure of a girl. The first spot metering is made on her face by bringing it in the microprism section. Then the second spot metering is made on her dress by directing the camera. Exposure is determined from the average of the two metered values to meet the photographer's requirement. It is also possible to input more than two points in the same

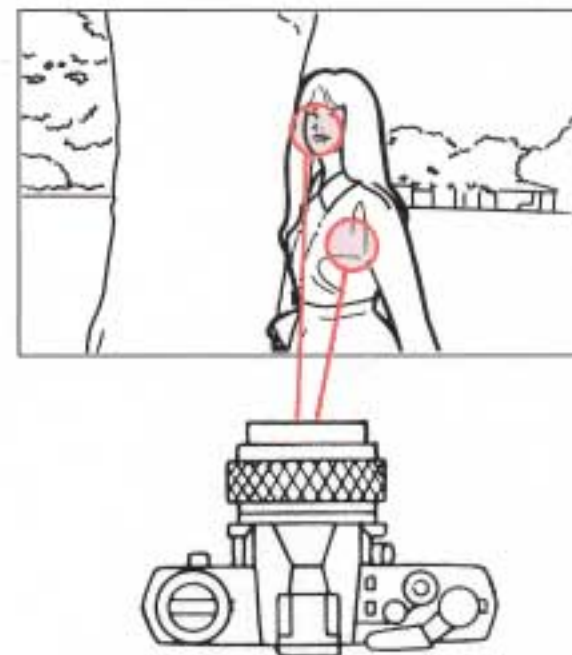

procedure. Metering is possible as many times as you want, but the spot metering allows only up to eight points to be stored in memory. If more than eight points are input, the last eight points are stored as a basis for determining the exposure value.



SOPHISTICATED MULTI-SPOT METERING



The OM-3Ti's multi-spot metering system provides highly sophisticated light measurements. Let us take an example in the picture above. If you want to place emphasis on the exposure of the girl, taking the background brightness into consideration, too, you can take two spot meterings on her face and one spot metering on the background, for instance. Exposure is determined from the average of these three values, with greater emphasis on the girl (a 2:1 lighting ratio). With this system, photographers can weight their exposures so as to make sure the prime subject is exposed properly and the secondary subject is con-

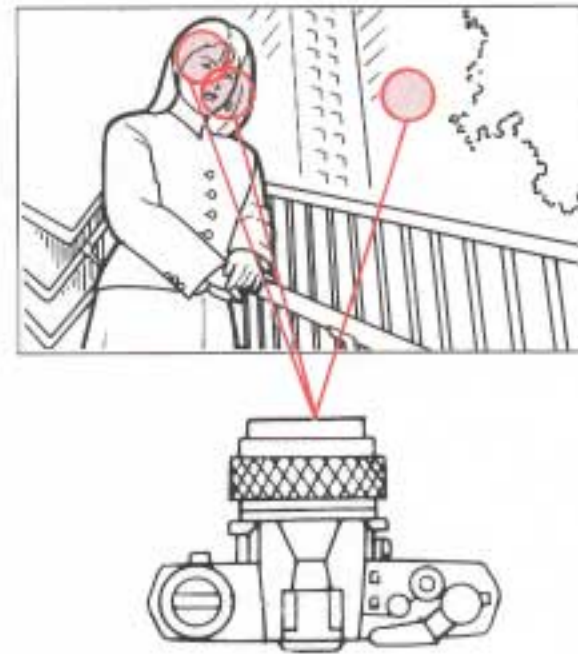

sidered. This is now done without guesswork, in a straightforward easy to understand manner.



HIGHLIGHT CONTROL



The Highlight button enables white objects to come out white. It is very useful for copy work and shooting light or white subjects on the whole. After spot metering is made on the white subject, then press the Highlight button. The exposure value needed for rendering it in true white will be automatically calculated and set.

In the example picture, the brightest spot of the tableware has been metered on spot metering. Pressing the Highlight button increases exposure and provides the correct overall exposure to make the tableware white and not a dullish gray.

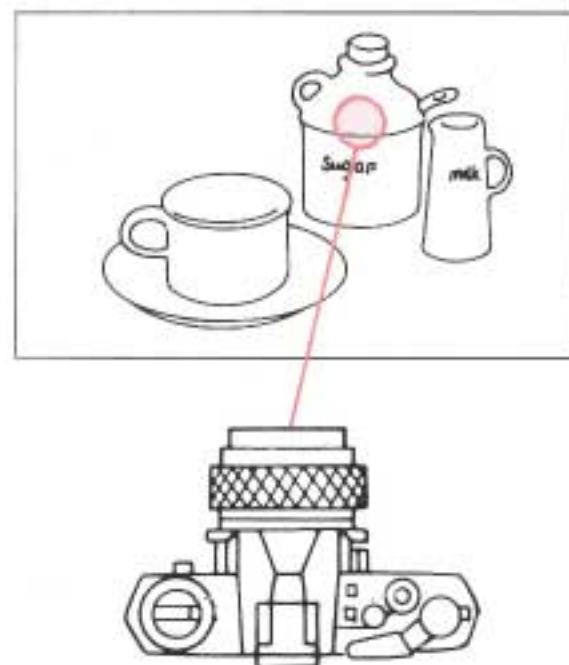

If the Highlight button is pressed again after the "highlight control" is once set up, only the "highlight control" is released and the camera returns to spot metering. To reset center-weighted averaging light metering, operate the Clear lever.

*If the Highlight button is pressed after several spots have been measured the exposure value for the brightest spot only will be adjusted.



SHADOW CONTROL



The Shadow button enables black objects to accurately come out black. It is very useful for shooting dark or blackish subjects on the whole.

After a spot metering is made on the black subject, then press the Shadow button. The exposure value needed for rendering it in a rich black will thus be automatically calculated.

In the example picture, the deep shadow area beside the dial has been inputted. As a result, the black portion comes out "black" without being grayish. By using this function, it is possible to express subtle tone variations on the dark area which would be



ignored in ordinary photography because they would appear as a dark gray without detail.

If the Shadow button is pressed again after the "shadow control" is already activated, only the "shadow control" is released and the camera returns to spot metering. To reset center-weighted averaging light metering, operate the Clear lever.

*If the Shadow button is pressed after several spot inputs, the exposure value for the darkest spot only will be adjusted.



VIEWFINDER INFORMATION

The OM-3Ti shows shooting information clearly on a large liquid crystal display so that you can concentrate your attention on the subject in the viewfinder. When shooting with center-weighted average light metering or with spot metering, correct exposure can be obtained simply by aligning the bar displays with the fixed point by manipulating the aperture and shutter-speed rings. Ease of use is further enhanced since the bar display moves in the same direction as the aperture ring rotates. The viewfinder displays various information as shown below:

Note: In actual shooting circumstances, displays will not appear simultaneously as shown.

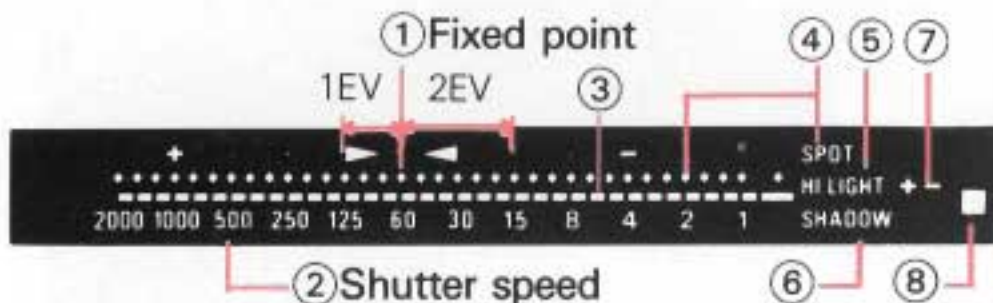

- ① This is a fixed point for correct exposure. ② The selected shutter speed. ③ The analog display of the metered value is shown by bar. ④ In the Spot mode, SPOT appears and input metered value and luminance value during metering is indicated by dot. ⑤ HI.LIGHT turns on when the highlight button is pressed. ⑥ SHADOW turns on when the shadow button is pressed. ⑦ +/- blinks during exposure compensation. ⑧ The green LED goes on after the flash has been

recharged. It blinks when the shot has been correctly exposed [when the camera is used with a T-Series flash or the F280 (Normal OTF mode)]. In addition, the entire bar display blinks if you are out of the camera's light metering range.

The light metering range of the OM-3Ti is as shown in the chart below.

Light Metering Range with 50mm F1.2

(Aperture setting)

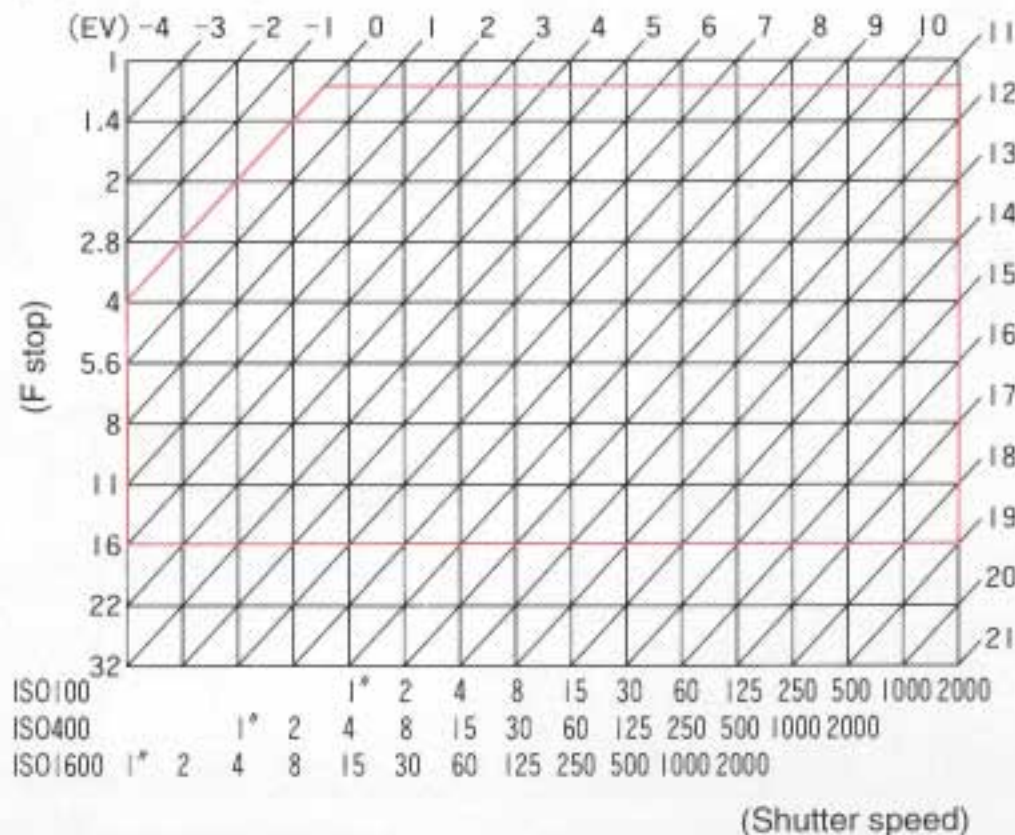

EXPOSURE COMPENSATION

The OM-3Ti also permits exposure compensation with the exposure compensation dial in OTF auto flash shooting. If the background is brighter than the subject, turn the dial and set it to a (+) side position. The amount of exposure is double on (+1) position, and four times on (+2) position. If the background is darker than the subject, turn the dial and set it to a (-) position. If the compensation dial is turned, the +/- display in the viewfinder blinks. The bar graph display shifts according to the amount of compensation.

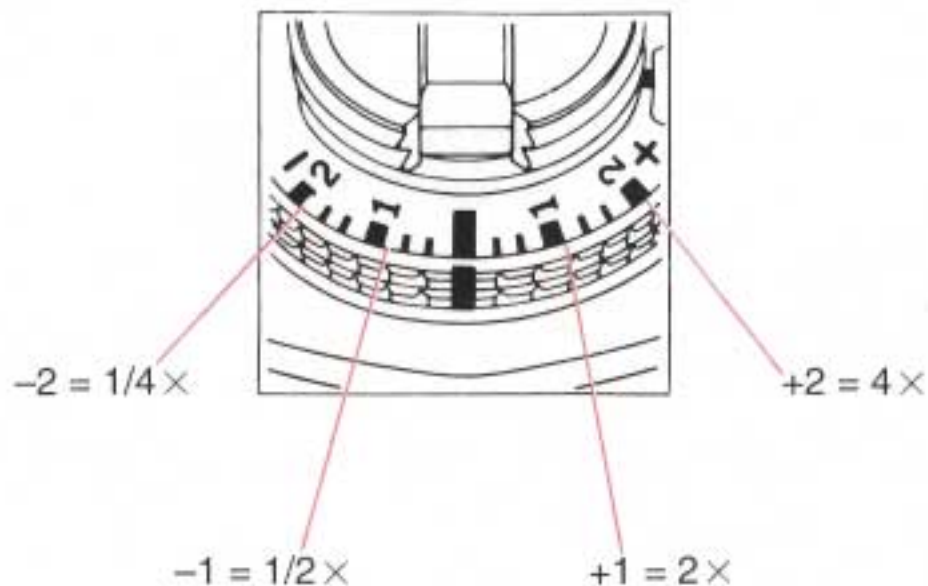

DEPTH OF FIELD

Depth of field is the area of acceptable sharpness in front of and behind the subject in focus. As you get closer to your subject or as you open your lens (e.g. from F16 to F2.8) the depth of field becomes shallower. By stopping your lens down (e.g. from F2.8 to F16) or getting farther away from your subject this depth of field can be increased.

The table below shows that when the camera-to-subject distance is 3m, the depth of field at F16 ranges from 1.93m to 6.93m.

As you press the preview button, looking through the viewfinder, you can ascertain the actual depth of field.

Depth of Field Table (50mm F1.8 lens)*

Circle of least confusion 1/30mm

F Stop	Camera-to-Subject Distance (m)									
	0.45	0.5	0.7	1	1.5	2	3	5	10	∞
1.4	0.45 -0.45	0.50 -0.50	0.69 -0.71	0.99 -1.02	1.47 -1.54	1.94 -2.07	2.86 -3.16	4.61 -5.46	8.55 -12.05	57.78 -∞
1.8	0.45 -0.45	0.50 -0.50	0.69 -0.71	0.98 -1.02	1.46 -1.55	1.92 -2.09	2.82 -3.20	4.56 -5.60	8.21 -12.79	45.05 -∞
2	0.45 -0.45	0.50 -0.50	0.69 -0.71	0.98 -1.02	1.45 -1.55	1.91 -2.10	2.80 -3.23	4.47 -5.68	8.05 -13.20	40.57 -∞
2.8	0.45 -0.45	0.49 -0.51	0.69 -0.71	0.97 -1.03	1.43 -1.57	1.88 -2.14	2.73 -3.33	4.28 -6.01	7.47 -15.15	29.02 -∞
4	0.44 -0.46	0.49 -0.51	0.68 -0.72	0.96 -1.04	1.41 -1.61	1.83 -2.20	2.63 -3.49	4.04 -6.57	6.74 -19.44	20.35 -∞
5.6	0.44 -0.46	0.49 -0.51	0.67 -0.73	0.94 -1.06	1.37 -1.66	1.77 -2.29	2.51 -3.74	3.75 -7.52	5.96 -31.31	14.55 -∞
8	0.44 -0.46	0.48 -0.52	0.66 -0.74	0.92 -1.09	1.32 -1.73	1.69 -2.45	2.34 -4.18	3.39 -9.61	5.09 -378.10	10.21 -∞
11	0.43 -0.47	0.48 -0.53	0.65 -0.76	0.90 -1.13	1.27 -1.84	1.60 -2.68	2.17 -4.91	3.02 -14.74	4.30 -∞	7.44 -∞
16	0.43 -0.48	0.47 -0.54	0.63 -0.79	0.86 -1.20	1.19 -2.05	1.47 -3.17	1.93 -6.93	2.57 -138.43	3.42 -∞	5.13 -∞

*Also applies to 50mm F1.2 lens

DEPTH OF FIELD SCALE

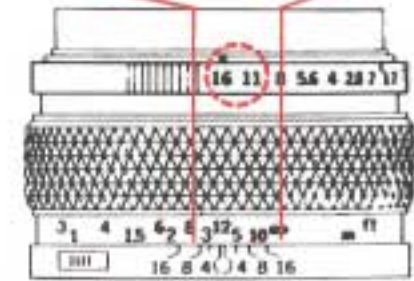
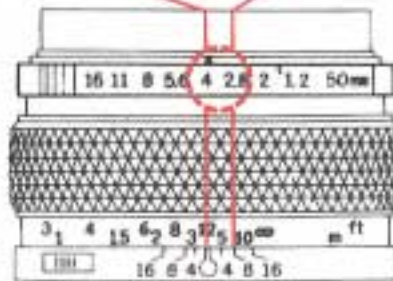
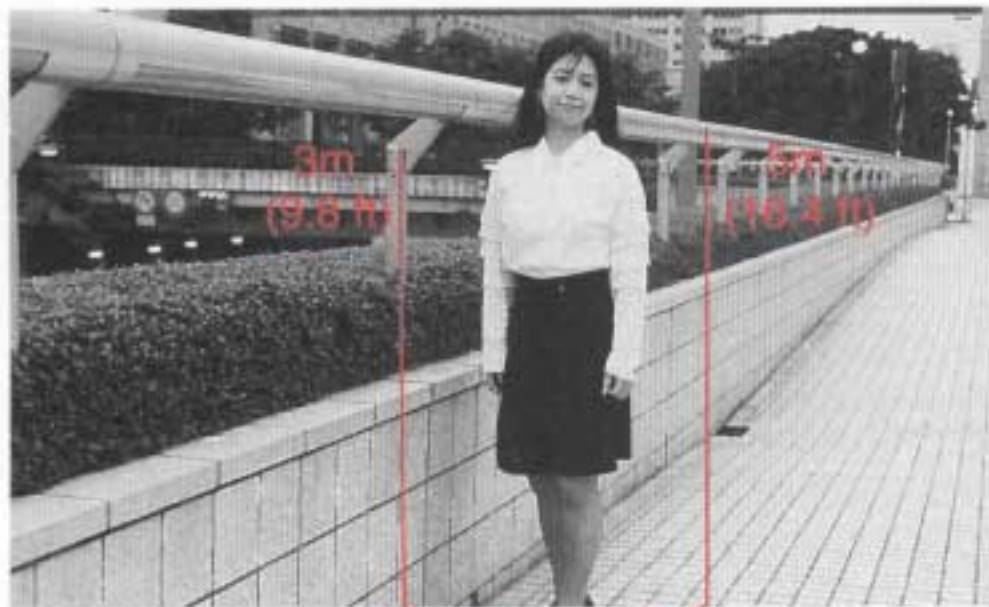

The double series of numbers engraved on the depth of field scale represent F stops: F4, F8 and F16. Once you have focused on your subject, all objects within the distance range indicated on the lens distance scale

between the marks for the F/stop you have selected will have acceptable sharpness.

- For other lenses, see the lens instruction manual.

PREVIEW BUTTON

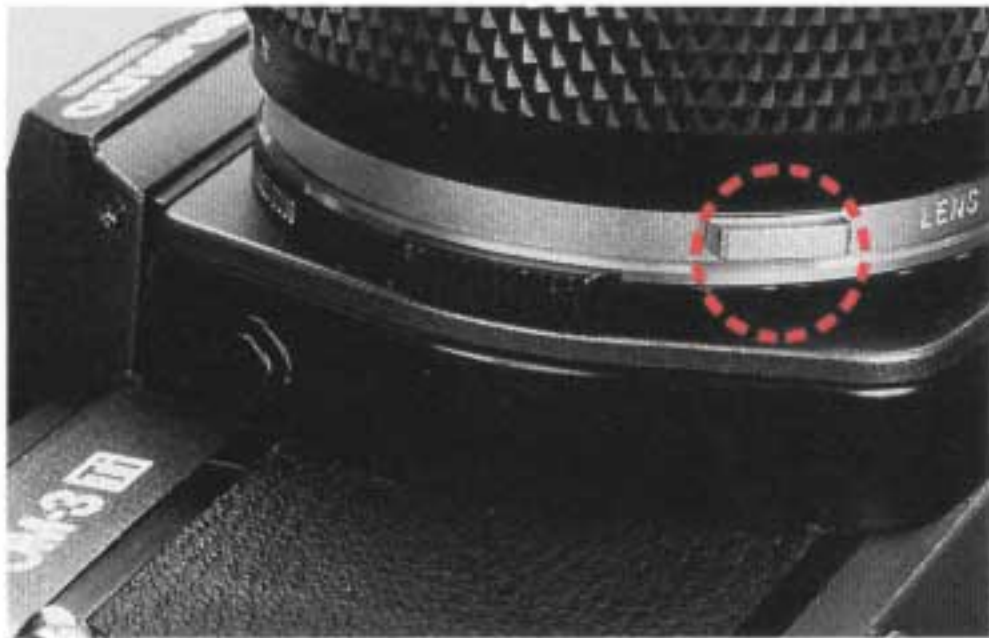

When you wish to see which objects fall within the acceptable zone of sharpness (depth of field), press the preview button on your lens. The diaphragm of the lens will stop down to the preset F stop enabling you to see the depth of field in the viewfinder.

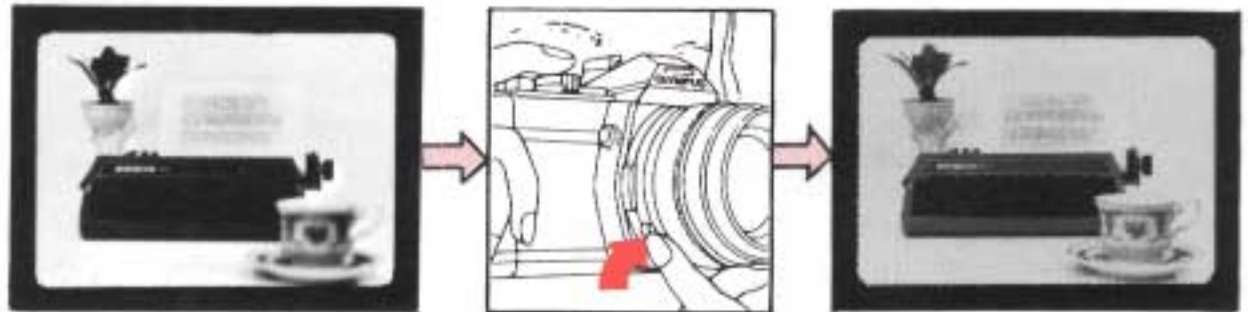

CAUTION: If you jerk the preview button while depressing the shutter release button halfway down the shutter might be released.

SHUTTER SPEEDS



This camera offers various possibilities for visual expression by changing the shutter speed.

High shutter speeds can be used to “freeze” a moving subject to give sharp definition of the image. Shutter speeds of $1/2000 \sim 1/500$ sec. can “stop” the movement of a considerably fast moving subject. A shutter speed of about $1/250$ sec. will be enough to shoot a child at play, if he is not moving too quickly. There are two methods for giving dynamic expressions. The first one is to blur out the movement of the subject itself, thereby creating a moving image. The second one is to pan the camera according to the movement of the subject. While the background is blurred, the subject is sharply defined to create a

moving image.

*In using slow shutter speeds, it is necessary to guard against camera shake. We will suggest a very practical method for choosing shutter speeds. Generally, shutter speeds of which denominator value is larger than the focal length value of the lens used are good for preventing camera shake. If you are using a 50mm lens, for example, shutter speeds of $1/60$ sec. or higher are best; and if you are using a 200mm lens, shutter speeds of $1/250$ sec. or higher are best.

BULB EXPOSURE



When an extended shutter speed is required, as in stellar photography and night-scene shooting, use the B (bulb) mode. Almost no battery power will be consumed in this setting. Automatic control of flash strength by the OTF auto metering function is also possible in this mode. However, the green LED in the viewfinder won't light.

Note: Use of a tripod and cable release is recommended for bulb shooting.



MULTIPLE EXPOSURES

By tripping the shutter several times on the same frame, multiple images are produced on the same frame.

This is how to do:

- ① After the first exposure is ended, erect the rewind crank and turn it clockwise as far as it will go to take up film slack.
- ② While holding both the rewind knob and rewind button with your fingers to prevent them from moving, wind the film advance lever.
In fact, the film is not wound and the shutter is cocked by this operation.
- ③ Press the shutter release as you would do normally, and double exposure will occur.
- ④ By repeating the steps ② and ③, the frame will be exposed as many times as you want. However, the frame counter advances each time the shutter release is pressed.
- ⑤ After ending the multiple exposure, put the front lens cap on and make a blind shot.
Note: The frame may shift slightly.

INFRARED PHOTOGRAPHY

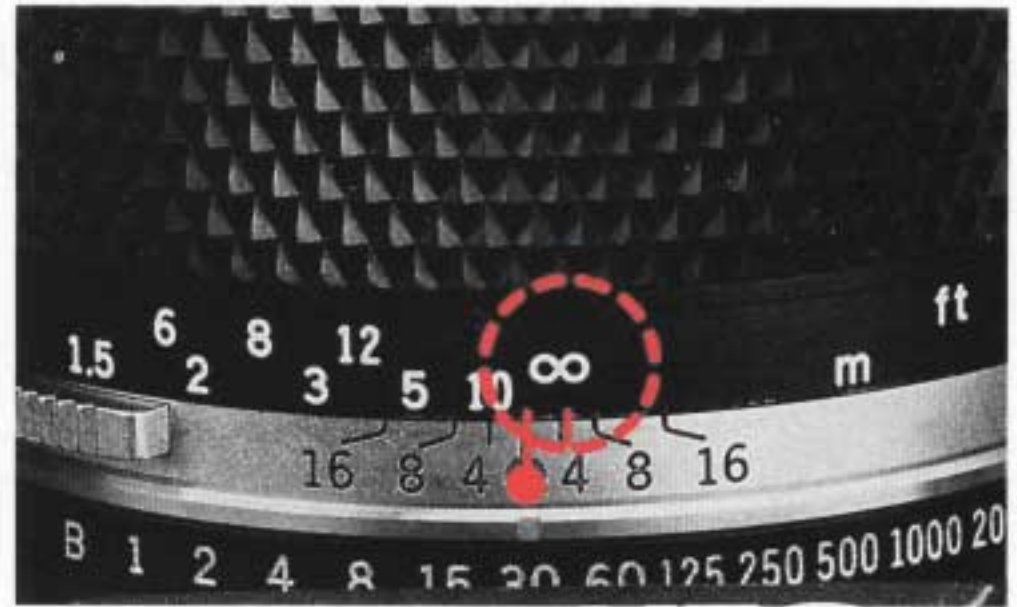

When shooting infrared pictures with infrared film and a red filter, the point of focus will slightly differ if you focus visually. The amount of shift varies with the lens and a red line or red dot is marked on the lens' depth of field scale to compensate for it. First, focus the lens without a red filter on as you would do normally. Next, read that distance on the distance scale and shift it opposite the infrared mark, then put on a red filter and shoot. (The above picture shows the distance at infinity.)



FLASH PHOTOGRAPHY



Electronic flash is very similar to daylight. As it is well balanced for daylight type color films that are most popular, the electronic flash is used for various

photographic applications. Electronic flash is especially useful in unfavorable lighting situations, ensuring easy, error-free picture taking. In dim light, for example, without an electronic flash you will have to use slow shutter speed with a risk of causing camera shake and blurred pictures. Under the illumination of a fluorescent lamp or incandescent lamp, the picture often does not come out with correct colors because it lacks proper color balance. Electronic flash solves all these problems.

The electronic flash can also be used in daylight as fill-in light for backlighted subjects or subjects with too strong a contrast as well as for freezing a fast moving subject.

Because the OM-3Ti provides full control of T-series flashes, there is no operation required on the flash side such as setting the film speed and aperture, mode switchover, and exposure compensation. Since The OTF auto light metering system can measure the light that the film, no exposure error occurs due to the difference in covering range of the flash's light receptor and picture frame. You can not only take flash pictures in the auto and manual modes, but also use sophisticated techniques such as bounce, diffuse, ultra close-ups, and multi-lamp flash with ease in a fully automatic mode.

OTF AUTO FLASH

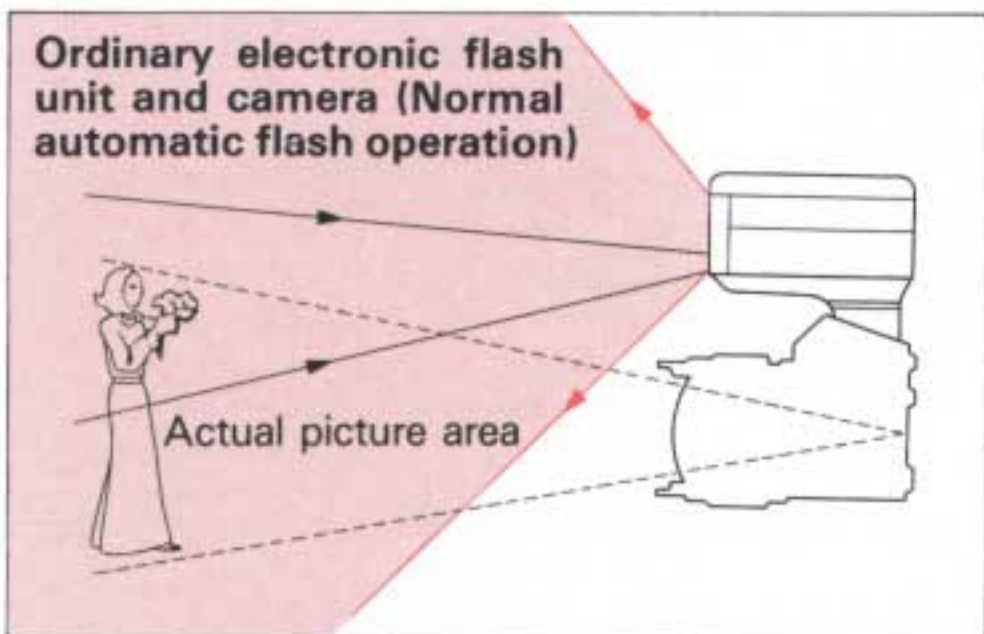
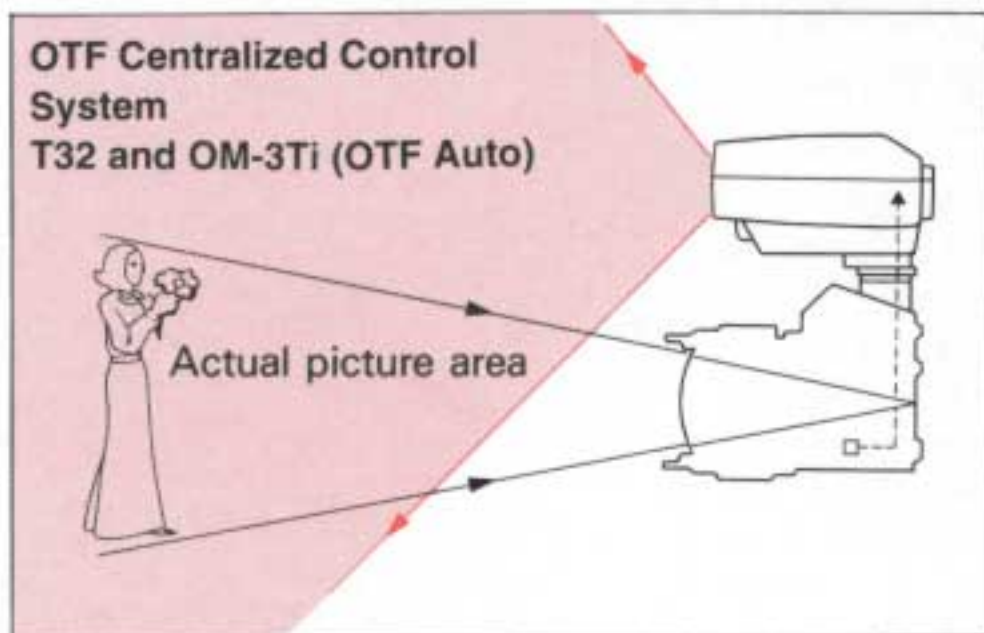

OPERATION OF T-SERIES FLASH

With a T-series flash on the camera, the flash mode will automatically switch according to the camera mode. If you take pictures in the auto mode, set the camera's mode lever to "TTL AUTO FLASH". When the green LED turns on in the viewfinder, the flash is ready for firing. Shoot using 1/60-sec. or slower shutter speed. If you take pictures in the manual mode, set the camera's mode lever to "X" and select 1/60-sec. or slower shutter speed. Flash strength is always at full emission. For more information, refer to the flash's instruction manual.

<OTF AUTO FLASH MODE>

± exposure compensation possible.
The required quantity of light is also adjusted depending on the amount of compensation.



Lights up when the flash is fully charged; blinks on correct flash firing.

MAIN SPECIFICATIONS OF T-SERIES FLASH

	Guide Number ISO 100 m (ISO 100 ft.)	Coverage Angle	Flash Duration	Number of flashes	Dimensions (less batteries) Weight
Electronic Flash T32	32 (104)	53° vertical, 74° horizontal	1/40,000 — 1/1,000 sec.	100 — 500 with AA-size alkaline batteries	81(H) x 70(W) x 104(D) mm 320 gr.
Electronic Flash T20	20 (66)	40° vertical, 58° horizontal	1/40,000 — 1/1,000 sec.	120 — 500 with AA-size alkaline batteries	68(H) x 57(W) x 77(D) mm 160 gr.
T28 Macro Single Flash 1	28 (92)	53° vertical, 74° horizontal	1/40,000 — 1/1,000 sec.	100 — 500 with AA-size alkaline batteries (T Power Control 1)	73(H) x 50(W) x 32(D) mm 110 gr.
T28 Macro Twin Flash 1	Single 28 (92) Twin 22 (72)	53° vertical 74° horizontal (Single)	1/40,000 — 1/1,000 sec.		73(H) x 50(W) x 32(D) mm 210 gr.
T10 Ring Flash 1	10 (33)	80°	1/40,000 — 1/330 sec.		86φ x 18 mm 95 gr.
T8 Ring Flash 2	8 (26)	80°	1/40,000 — 1/330 sec.		91φ x 18.5 mm 110 gr. (Reflector 1: 200φ x 32 mm 80 gr.) (Reflector 2: 150φ x 32 mm, 40 gr.)

MAIN SPECIFICATIONS OF F280

Guide number (ft.)	28 [ISO 100 meters at Normal (92) OTF Flash]
Coverage angle	53° vertical, 74° horizontal
Number of flashes	80 — 6,000 with AA-size alkaline batteries
Flash Duration	Super FP Flash mode: 1/25 sec. Normal OTF Flash mode: 1/40,000 — 1/1,000 sec.
Dimensions Weight	110(H) x 68(W) x 71(D) mm 250 gr. (less batteries)

USING ELECTRONIC FLASHES OTHER THAN THE T-SERIES FLASH UNITS

- ① Mount the flash on the accessory shoe. If you are using a flash that has no direct contact, connect the flash synchro cord to the synchro terminal.
- ② Set the film speed on the flash.
- ③ Set the shutter speed ring to 1/60 sec.
- ④ If the flash has an AUTO/MANUAL switching device, set it to either AUTO or MANUAL.
- ⑤ Determine the aperture and set it on the camera. If you are using an auto flash, set the desired F stop on the flash unit and then set the aperture ring to this F stop. If you are using a manual flash, calculate the aperture by the following formula or using the flash's calculator panel and set it with the camera's aperture ring. (ISO 100m/ft.)

$$\text{Aperture} = \frac{\text{Flash guide number}}{\text{Flash-to-subject distance (m/ft.)}}$$

BOUNCE FLASH

The T32 has an adjustable flash head that tilts as much as 90° up and 15° down. When combined with the Power Bounce Grip 2, angle can be adjusted up to 90° up, 20° down, 240° horizontally, and 60° to the camera side. Bounce flash is possible in the OTF Auto Flash mode with or without the Power Bounce Grip 2.

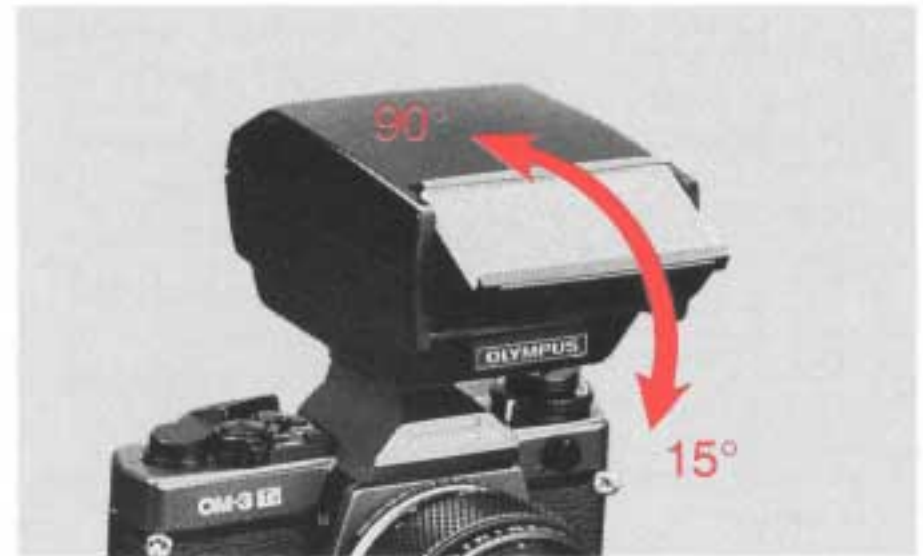

Electronic Flash T32



Power Bounce Grip 2



SHOOTING WITH A MOTOR DRIVE



Shooting with a motor drive is very exciting because it enables you to capture your subject in a critical moment by making several shots in a second.

The high speed OM System motor drive has achieved an extremely compact and lightweight design to take full advantage of its ease of operation and high maneuverability. Motor Drive 2 is the 5-frames-per-second high speed motor drive with a built-in computer. It is equipped with an LCD display of the number of frames and the operating procedure and also permits motorized rewind when it is attached to the OM-3Ti.

In addition, the Winder 2 is also available, which offers both single-frame exposures and sequential exposures on dial switching.

The OM System's outstanding maneuverability and operability are ideal for shooting dynamic sports photos and documentary press photos. Various accessories can be connected by a direct contact.

- The Motor Drive 1 can also be used, but motorized rewind is impossible.

MOTOR DRIVE GROUP

Selection of Motor Units

- **Motor Drive 2.** if you want to shoot very fast moving subjects such as a dashing animal or a racing car driving at full speed, the Motor Drive 2 is the best choice because it permits continuous shooting at a high speed of up to five frames a second. This quick shooting capability will often allow you to catch a dramatic instant.
- **Winder 2.** The Winder 2 is very helpful for shooting impressive moments such as sports scenes and children at play. As it permits continuous shooting at a rate of up to 2.5 frames a second, you will not miss a decisive moment.

Selection of Power Sources

- For the Motor Drive 2, the following two power units are available: a small, lightweight and portable flat-type rechargeable power unit, M.15V Ni-Cd Control Pack 2, and a grip-type battery power unit, M 18V Control Grip 2, which provides added stability when used with a telephoto lens.
- The Winder 2 has a self-contained power supply, but an external power units is also available: M.6V Power Pack 1.

Remote Control System

- **Winder 2** allows you to remote-control the camera using the dedicated remote cord. Tripping the shutter without camera shake makes it very useful for shooting wild birds and animals, macro-photography and photomicrography.
- **M.Quartz Remote Controller 1** is provided with an electronic counter which allows you to trigger the camera and check operation via an LCD display from a remote location. It can also be used to switch between single-frame and continuous shooting modes. You can select an interval from 0.5 seconds to 24 hours between shots photographed in continuous mode.
- **M.Remote Cord 1.2m/5m** connects the Winder 2 with the camera.

RECORDATA BACK 4



Interchangeable camera back for data imprinting. Data imprinting is possible in the following forms: (1) Year—month—day (Japanese date description), (2) Month—day—year (American date description), (3) Day—month—year (European date description), (4) Hour—minute, (5) Counter (additive type), (6) Classification number up to 6 digits. Provided with an imprint clear switch to be used when data imprinting is unnecessary. This Recordata Back can also be used as a clock which indicates the hour, minute and second via a Time Button.

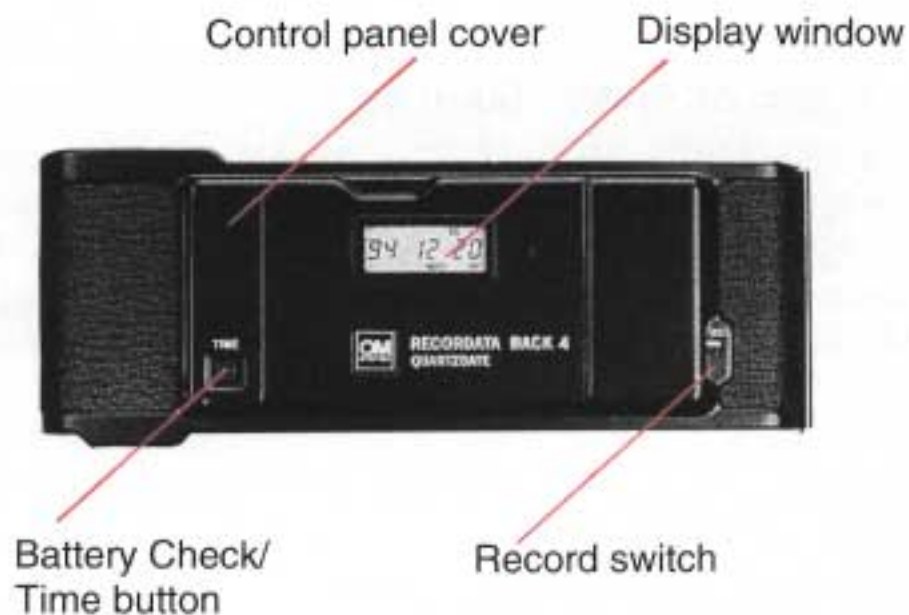

MACROPHOTOGRAPHY

The world of macrophotography is filled with marvelous discoveries. However, macrophotography has been generally considered difficult; calculations of correct exposure, in particular, have been a difficult job even for professionals.

Equipped with an OTF auto metering, the OM-3Ti has solved this problem to always provide correct exposure, regardless of the magnification and aperture. All complicated exposure calculations for multi-lamp flashing are now quite unnecessary. The OM-3Ti also provides a complete macro system including a wide choice of macro lenses that offer excellent life-size and magnified pictures as well as extension units that enable you to take handheld macro pictures.



CHART OF PHOTOGRAPHIC RANGES

ZUIKO INTERCHANGEABLE LENS	EXTENSION UNITS	360	180	120	72	60	45	36	24	12	7.2	3.6	MICRO					
		x	x	x	x	x	x	x	x	x	x	x	100x	500x	1000x			
		240	120	80	48	40	30	24	16	8	4.8	2.4						
		0.1x	0.2x	0.3x	0.5x	0.6x	0.8x	1x	1.5x	3x	5x	10x						
PROFESSIONAL METHOD	INTERCHANGEABLE LENSES	0.1 - 0.14x																
	ZUIKO MACRO 50mm F2/F3.5	0.1 - 0.5x																
	ZUIKO MACRO 90mm F2	0.1 - 0.5x																
	ZUIKO MACRO 135mm F4.5	TELESCOPIC AUTO TUBE 85 - 118	0.1 - 0.43x															
		AUTO BELLOWS	0.1 - 1x															
	ZUIKO 1:1 MACRO 80mm F4	TELESCOPIC AUTO TUBE 85 - 118	0.1 - 1.2x															
		TELESCOPIC AUTO TUBE 85 - 118	Combined with close-up lens		1x		2x											
		AUTO BELLOWS	0.09x - 0.5x		2.2x													
	ZUIKO MACRO 38mm F2.8	AUTO EXTENSION TUBE 14	1.7x		1.8x													
		AUTO EXTENSION TUBE 25	2x		2.1x													
		TELESCOPIC AUTO TUBE 85 - 118	3.1x		4.5x													
		AUTO BELLOWS	2.3x		6.7x													
	ZUIKO MACRO 38mm F3.5	TELESCOPIC AUTO TUBE 85 - 118	2.5x		4x													
		AUTO BELLOWS	1.8x		6.1x													
	ZUIKO MACRO 20mm F2	AUTO EXTENSION TUBE 14	4.2x		4.4x													
		AUTO EXTENSION TUBE 25	4.7x		4.9x													
		TELESCOPIC AUTO TUBE 85 - 118	8.8x		9.5x													
		AUTO BELLOWS	5.3x		13.6x													
ZUIKO MACRO 20mm F3.5	TELESCOPIC AUTO TUBE 85 - 118	5.8x		8.3x														
	AUTO BELLOWS	4.3x		12.4x														
ZUIKO MACRO LENSES	MACROPHOTO GRAPHIC EQUIPMENT PMT35	0.5x		16x														
MICROSCOPE	DM MOUNT PHOTOMICRO ADAPTER	3.3x		750x														
COMPOSITE METHOD	STANDARD LENS	CLOSE-UP LENS	0.13x - 0.28x															
		AUTO EXTENSION TUBE 7	0.16x - 0.3x															
		AUTO EXTENSION TUBE 14	0.3x - 0.45x															
		AUTO EXTENSION TUBES (7+14)	0.45x - 0.58x															
		AUTO EXTENSION TUBE 25	0.5x - 0.65x															
		AUTO EXTENSION TUBES (7+25)	0.85x - 0.8x															
		AUTO EXTENSION TUBES (7+14)	0.8x - 0.95x															
		AUTO EXTENSION TUBES (7+14+25)	0.95x - 1.1x															
	ZUIKO MACRO 50mm F2/F3.5	CLOSE-UP LENS	0.13x - 0.63x															
		AUTO EXTENSION TUBE 25	0.5x - 1x															
		ZUIKO MACRO 50mm F2/F3.5 OR STANDARD LENS	TELESCOPIC AUTO TUBE 85 - 118	1.8x - 2.8x														
			AUTO BELLOWS	0.71x - 4.1x														
ZUIKO MACRO 90mm F2	TELESCOPIC AUTO TUBE 85 - 118	0.72x - 1.72x																

MACRO PHOTO UNITS

Simplified Macro System

It allows you to take close-ups up to life size with ease. With this macro system, you will come upon unexpected and wonderful discoveries in tiny things around you such as writing instruments, printed letters, flowers in a vase, etc.

- **Close-up Lenses 49mm** $f = 40\text{mm}$. Simply screw them in the front of the standard lens, and you can take up to 0.63X close-ups.
- **Auto Extension Tubes 7, 14 and 25** These adapters are placed between the lens and camera body and available in three thicknesses: 7mm, 14mm and 25mm. They can be used in seven combinations. With the standard lens, you can take up to 1.1X close-ups.

Basic System

This is a complete macro system that permits low to high magnifications. It will produce a brilliant image of the marvelous world of tiny things such as the geometric beauty of the compound eye of a dragon fly and close-ups of flowers. An indoor type and outdoor type are available.

Indoor type: This system uses an auto bellows, macro photo stand, top-light illumination device, etc. in combination with various macro lenses. It is suited for taking high-magnification pictures in a room or studio.

- **Auto Bellows** A basic unit that helps you take full advantage of the system's capabilities with a variety of lighting units and mounts. The stop-down lever that lets you use a variety of OM System lenses at preset aperture or operated in combination with the double cable release, affords an automatic diaphragm photo function.
- **Zuiko Macro 20mm F2** Large-aperture macro lens designed exclusively for macrophotography. Combined with the Auto Bellows, it permits magnifications ranging from 4.2X to 16X. Provided with a helicoid for fine focusing.

- **Zuiko Macro 38mm F2.8** Bright, high-magnification macro lens designed exclusively for macro photography. Combined with the Auto Bellows, it permits magnifications ranging from 2.3X to 6.7X. Provided with a helicoid for fine focusing.
- **Macrophoto Stand VST-1W** A compact and sturdy multipurpose stand for solid camera support in close-up and macrophoto work. Comes with frosted stage glass for incident light and may be used in conjunction with Trans-illuminator Base X-DE for lighting of transparent subjects from beneath.
- **Epi-illuminator PM-LSD-W** A two-piece lighting set providing ideal reflected light for macrophotography. Moving the filament allows you to change the position and field of illumination.



Outdoor type: This is a handy and highly manueverable system which includes macro lenses, telescopic auto extension tube 65—116, etc.

- **Telescopic Auto Extension Tube 65—116** With its variable tube length, this auto extension tube enables you to change the shooting distance and magnification freely.
- **Zuiko 1:1 Macro 80mm F4** This lens is designed specifically for life-size reproductions. It functions at its best at a 1:1 ratio, but gives outstanding images from 1/2 to 2X life-size, the range of magnifications available when used with the Auto Bellows. With



the Telescopic Auto Tube it goes up to life-size, and the close-up lens is used to extend the range to 2X magnifications.





- **Zuiko Macro 135mm F4.5** Shoots from infinity to life-size with the Auto Bellows, or 0.43X magnifications with the Telescopic Auto Tube, giving long working distances and minimal perspective distortion. It has a helicoid ring for fine focusing.
- **Zuiko Macro 50mm F2** Large-aperture macro lens which is as fast as a normal lens. Basic design magnification 0.1X. Because aberrations are minimized at close and far distances, this lens exhibits excellent resolution from infinity to as close as 0.24m.
- **Zuiko Macro 50mm F3.5** Designed for optimum performance at 1/10 magnifications, this outstanding lens gives superb results in general purpose photography at infinity, or for macro subjects as large as 1/2 life-size.
- **Zuiko Macro 90mm F2** This medium-range telephoto macro lens covers a wide focusing range from 1/2X close-ups to infinity. With its large aperture ratio of F2, it provides excellent image definition in macro photography and promises good performance at infinity for extended picture-taking possibilities.



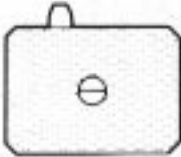
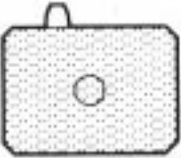

FINDER GROUP UNITS

TYPE	SCREEN	FEATURES
<p>2-4 All matte type (for most lenses)</p>		<p>Bright focusing screen newly developed. Suitable for general photography. Accurate focusing can be achieved especially in combination with a fast lens. Suitable for shooting with a lens having a wide-open aperture of F4 or less. (There is a circle showing the spot metering range.)</p>
<p>2-13 Micro/split image-matte type (for most lenses)</p>		<p>Bright focusing screen newly developed. Most suitable for normal photography, like the 1-13. Since the central split-image is encircled by a microprism collar and the outer area has a matte surface, the screen can be used in the same way as the standard 1-1 and 1-3 Screens. When a lens with a maximum speed of F5.6 or slower is used, the prisms darken and the focusing must be made on the matte area.</p>

The above screens can also be mounted on the OM-2S/P, 2S, 3, 4, 4Ti and 4T but not on the OM-1, 1N, 2 and 2N.

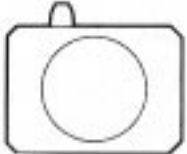
TYPE	SCREEN	FEATURES
<p>1-1 Microprism-matte type (for most lenses)</p>		<p>Standard type, suitable for general photography. Fast and accurate focusing is done on the central microprism spot as well as on the surrounding matte area. When a lens with a maximum speed of F5.6 or slower is used, the microprism darkens and focusing must be made on the matte area.</p>
<p>1-2 Microprism-matte type (for standard & telephoto lenses)</p>		<p>Suitable for general photography in conjunction with a standard or telephoto lens. Focusing is done on the microprism spot as well as on the matte area. When a lens with a maximum speed of F8 or slower is used, the split prism darkens.</p>

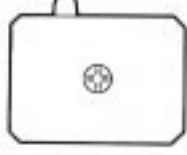
TYPE	SCREEN	FEATURES
<p>1-3 Split image-matte type (for most lenses)</p>		<p>Suitable for general photography ensuring critical focusing, and ideal for photographers who prefer the split-field and coincidence type focusing. When a lens with a maximum speed of F5.6 or slower is used, the split prism darkens.</p>
<p>1-4N All matte type (for most lenses)</p>		<p>Suitable for general photography and ideal for photographers who prefer a view field free from microprism or split prism and for those who are accustomed to focus using matte area. Also suitable for super telephoto photography and close-up photography in conjunction with macro lenses and Auto Bellows. (There is a circle showing the spot metering range.)</p>
<p>1-5 Microprism-clear field type (for wide angle & standard lenses)</p>		<p>This transparent screen provides an exceptionally bright finder image. Highly suitable for snapshots using wide angle lenses. The lack of matte surface means depth-of-field effects cannot be ascertained.</p>
<p>1-6 Microprism-clear field type (for standard & telephoto lenses)</p>		<p>This screen provides an extremely bright finder image. Focusing is done on the microprism spot. The lack of matte surface means depth-of-field effects cannot be ascertained.</p>
<p>1-7 Microprism-clear field type (for super telephoto lenses)</p>		<p>Developed primarily for use with super telephoto lenses this clear field screen provides an extremely bright finder image. The micro-prism spot remains bright even with a lens whose maximum speed is F11. The lack of matte surface means depth-of-field effects cannot be ascertained.</p>
<p>1-8 All matte type (for telephoto lenses & astronomical telescopes)</p>		<p>This screen is ideal for use with super telephoto lenses of 300mm or more in focal length, or for astrophotography. The extreme fineness of the matte surface permits outstanding field definition. More accurate focusing may be achieved by the use of the Varimagini Finder.</p>

TYPE	SCREEN	FEATURES
<p>1-9 Clear field type (for endoscopic photography)</p>		<p>Designed for use with OLYMPUS fiberoptic endoscopes. This condenser type screen without fresnel lens requires no focusing when a special adapter couples the camera with the fiberscope. Exposure is made automatically by the light supply.</p>
<p>1-10 Checker-matte type (for shift lens)</p>		<p>The grid lines engraved on the all-matte surface are used for vertical and horizontal picture alignment. Though originally designed for architectural photography with the shift lens, it is also suitable for general and super-telephotography, and close-up/macro photography with macro lenses and Auto Bellows.</p>
<p>1-11 Cross hairs-matte type (for close-up & macro-photography)</p>		<p>Highly advantageous for close-up and macro photography with Auto Bellows and extension tubes. For focusing in low magnification close-up photography, use the matte area and in macro photography greater than life size, use the double cross hairs the same way as with the 1-12.</p>
<p>1-12 Cross hairs-clear field type (for photomicrography & macrophotography greater than life size)</p>		<p>The transparent screen offers the photographer focusing with an unusually bright finder image. To focus, first correct your diopter using a dioptic correction lens or Varimagini Finder so that each line of the double cross hairs can be seen clearly and separately. Then bring the Spacemen into focus.</p>
<p>1-13 Microprism/split image-matte type (for most lenses)</p>		<p>Most suitable for normal photography, this screen assures pinpoint focusing. The central split-image rangefinder is encircled by a microprism collar. Since the outer area has a matte surface, the screen can be used in the same way as the standard 1-1 and 1-3 Screens. When a lens with a maximum speed of F5.6 or slower is used, the prisms darken and the focusing must be made on the matte area.</p>
<p>1-14 Microprism/split image-matte type (for most lenses)</p>		<p>Most suitable for normal photography. The central split-image range finder, encircled by a microprism collar, is inclined 45 degrees to allow easy focusing on subjects with vertical or horizontal lines. When a lens with a maximum speed of F5.6 or slower is used, the prisms darken and focusing must be made on the matte area. The meter needle gives correct light readings.</p>

SELECTION OF FILTERS

With the aperture and shutter, the camera can control the amount of light, but not the quality of light. Therefore, it is necessary to filter the light components that are not wanted for visual expressions. Filters are useful for this purpose.

■ Filters for color and B&W films

Skylight (1A): For absorbing ultraviolet rays. It yields natural colors on the part of a subject in the shade under a blue sky by filtering the light from the sky. It can be used to protect the lens, but it is not recommended to use this filter for subjects which are not affected by ultraviolet rays or a blue sky because the color balance may be impaired.

L3 (UV): In the open air on a bright day, there are a lot of ultraviolet rays to which photographic films are sensitive although they are invisible to the human eye. Affected by these rays scattering in the air, distant landscapes may turn out whitish and unclear. The skylight filter cuts off detrimental ultraviolet rays. It can always be used for lens protection.

ND2/ND4: Neutral gray filter for reducing the light quantity without affecting the color and contrast. Use this filter if you want to open the aperture for a blurred background, or produce special "blur" effects with a slow shutter speed, or to reduce the light intensity without increasing the shutter speed on a reflex telephoto lens which has no aperture control mechanism. Available in two types: ND2 for reducing the light intensity by one stop and ND4 for reducing it by two stops.

C-POL (circularly polarizing filter); For blocking the light reflected from the surface of glass, water and tile to take sharp pictures of fish in the water, subjects behind a show window, etc. It can also be used as a contrast filter for color pictures of landscapes, because it cuts off the light reflected from dust or vapor under a blue sky as well as the surface of leaves and grass. As this is a circularly polarizing filter it can be used on cameras using a half-mirror such as the OM-3Ti.

■ Filters for B&W films

Y48 (Y2): Yellow filter which absorbs ultraviolet, violet and part of blue light. It decreases the effect of blue sky and brings out the clouds. It is also useful for taking distant shots on a bright clear day. With this filter, the sensitivity of films becomes closer to that of the human eye so that ordinary shots at close distance will appear very natural with a slightly enhanced contrast.

O56 (O2): Orange filter which absorbs a wider range of light (from ultraviolet rays to blue-green light) than Y48, thus producing an intensified contrast. It can also be used for infrared film.

R60 (R1): Red filter which absorbs violet, blue, green light and part of yellow light, thus blocking almost all light except for red and similar colors. As it produces a strong contrast effect, distant shots turn out sharp and crisp while the tone of blue sky weakens. This filter is indispensable for bringing out the effects of infrared film.

■ Filters for color films

A4 (81C): On a cloudy or rainy day, pictures taken on daylight film tend to appear blueish. This amber film suppresses blue and produces natural color reproduction. It can also be used for creating warm and mild effects intentionally under ordinary light.

B4 (82C): Subjects under morning or evening glow will turn out reddish if they are taken on daylight film. This blue filter suppresses red and produces natural color reproduction. In contrast with A4, it can be used for bringing out cool, blueish effects under ordinary light.

Handling Care

Take care in handling the camera.

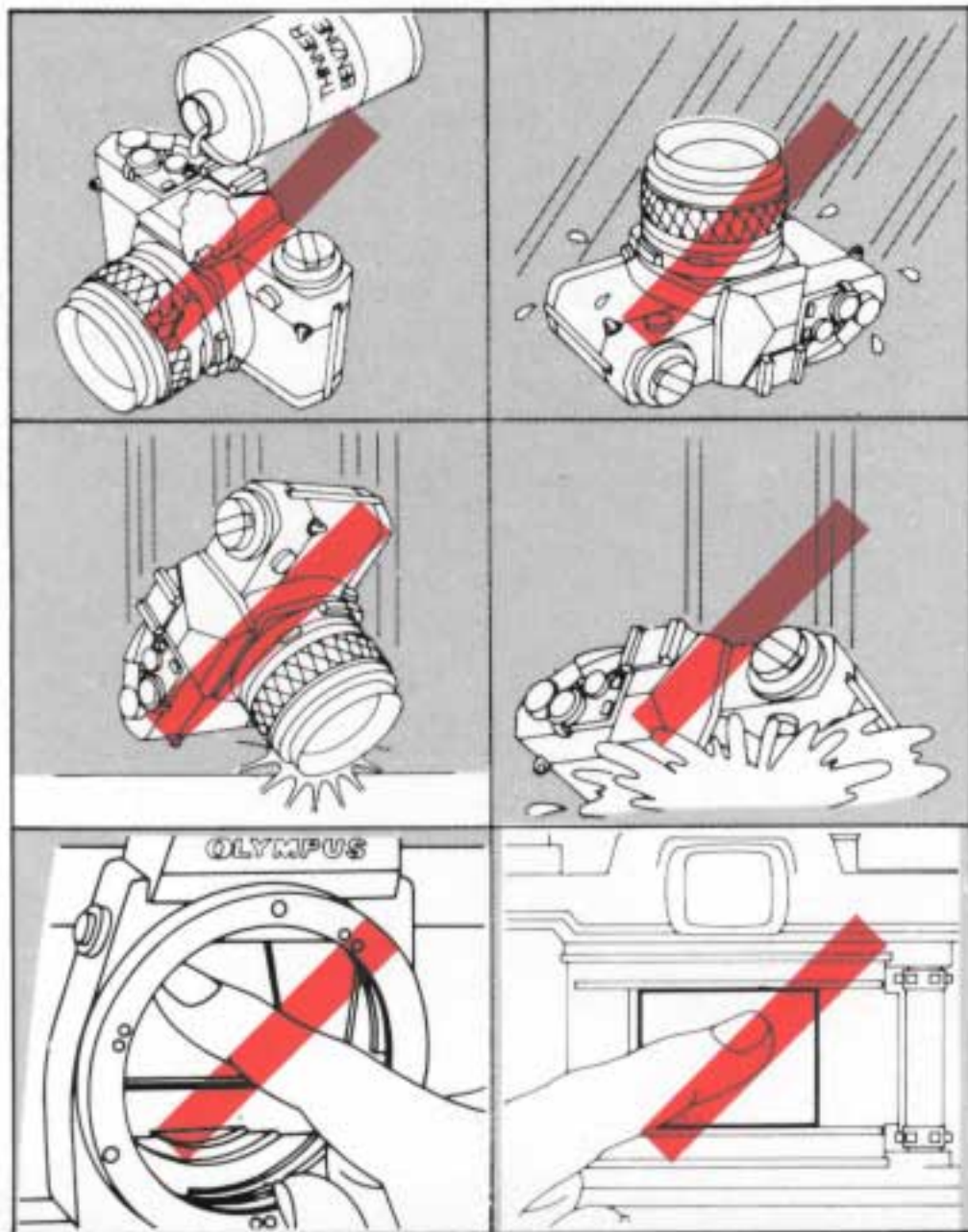

Do not use extra force.



Storage Care

Guard against high temperature and magnetic fields.



Battery Precaution

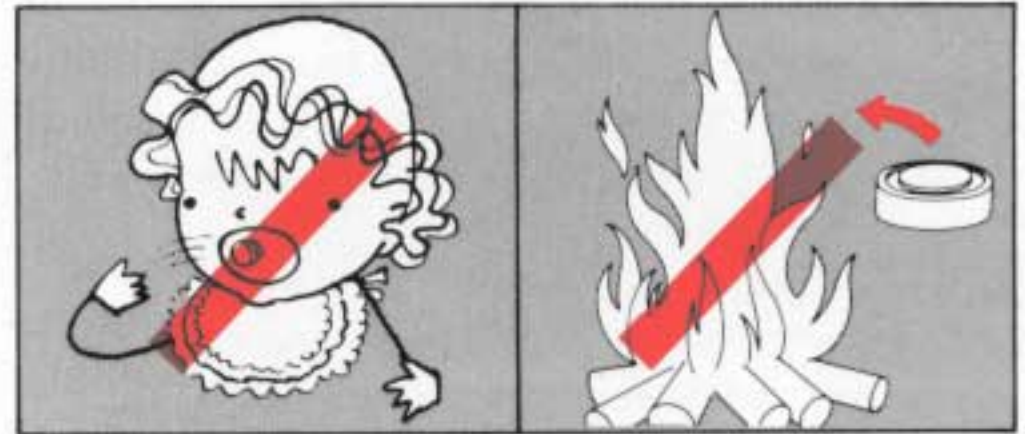

QUESTIONS AND ANSWERS (1)

Q: There are sometimes scratches on the film.

A: The cause may be a soiled film passage. The film compartment may be soiled by film debris accumulated during long use of the camera. Be sure to dust off the camera periodically.

Q: How do I store the camera?

A: Remove the camera from its case and store it in a dry, well-ventilated place. Protect against excess moisture by using packs of silica gel or other desiccant in the storage area. Do not store the units near moth balls or similar volatile chemical materials to avoid the possibility of damage to metal surfaces.

Q: How can I turn off the beep?

A: Operate the flash mode lever while pressing the battery check button. You can also turn on the beep in the same way.

Q: This camera doesn't have a power switch. What should I do when I don't use the camera?

A: The batteries will last for approx. 1 year when the camera is used under ordinary circumstances. When the bulb mode is engaged, battery consumption is further decreased because the circuitry does not operate even if the shutter release is pressed accidentally. Remove the batteries when the camera is not to be used for an extended period of time.

Q: When will spot metering be canceled?

A: (1) When the shutter is released. (2) When the clear lever is operated. (3) When more than 60 seconds have elapsed. (4) When the flash mode lever is operated. (5) When the lens is changed. (6) When a T-Series flash or the F280 is switched on. (7) When the shutter speed ring is set to B.

Q: The flash fires even with 1/125-sec. or faster shutter speed. Can I take a properly exposed picture?

A: Unless the Super FP mode is engaged, synchro-

nization won't be achieved even if the flash fires. Select 1/60-sec. or slower shutter speed.

Q: Why did the viewfinder displays disappear suddenly?

A: Due to its power-saving design, the OM-3Ti turns off the displays when no operation occurs for more than 60 seconds. To resume the display, press the shutter release halfway, press the battery check button fully, or operate the clear lever.

Q: The tip of the shutter speed display bar blinks frequently during light metering.

A: This occurs mostly in the case of metering under a fluorescent lamp. Though the fluorescent lamp appears to the human eye as it were lighting continuously, it is in fact blinking repeatedly at a frequency of 50 — 60 cycles a second. Each particle of the shutter speed bar display represents 1/3 EV. Therefore, if the luminosity is unstable or in the case

of a luminance mediated between the bar tip and the adjacent particle, the bar tip will blink.

In actual exposure determinations, however, variations of light are averaged, causing no problem.

Q: After operating the highlight (or shadow) button, I have pressed the spot button by error.

A: If the new spot exceeds the highest value (or falls below the lowest value) that was already input after the highlight (or shadow) button has been operated, exposure is changed according to that value. At this time, the bar display shows the calculation result after showing the highest (or lowest) value again. If the calculated result is over the display's highest value, or under its lowest value, the bar display won't change.

Q: When I used the highlight (shadow) button, the picture did not come out with the desired colors.

A: Colors on negative film may sometimes be corrected automatically in the printing process.

QUESTIONS AND ANSWERS (2)

Q: Why won't the shutter release button move when I press it?

A: The film advance lever may not have been fully advanced or the film may have come to its end.

Q: Why can't I advance the film?

A: You may have wound the film already. Try pressing the shutter release button.

Or, the film may be fully exposed. Check the exposure counter. If you feel tension on the film advance lever, DO NOT FORCE IT. Rewind the film.

Q: The rewind crank does not turn when I try to rewind the film. What should I do?

A: Press in the rewind button.

Q: Is it normal for the microprism in the center of the viewfinder to "shimmer" and darken?

A: Yes, when a lens with a maximum aperture smaller than F5 is mounted on the camera. It also happens with other lenses when the depth of field preview

button is pressed.

Q: What type of batteries should I buy?

A: Purchase two SR44 silver-oxide or LR44 alkaline batteries. Silver-oxide batteries last longer. You can also use one CR-1/3N lithium battery. Do not use different types of batteries at the same time (with MR44, etc.), even when they are of the same size. Always replace the two batteries at the same time and do not use an old and a new battery together.

Q: When should I check the batteries?

A: (1) When new batteries are inserted. (2) After the camera hasn't been used for a long time. (3) Before beginning a prolonged period of use.

Q: Why can't I set the ISO film speed I need?

A: At the most, 3 stops can be advanced in a single stroke of the dial. If this is not enough stops, lift up and rotate the outer collar of the dial unit it stops; then release the collar and rotate the collar and dial

together until the white line is aligned with the black index on the pentaprism. Repeat this procedure until you reach the ISO speed you need.

Q: With ISO 3200, I made exposure compensation on the minus (-) side.

A: Exposure compensation on the minus side is impossible at ISO 3200. If you have made it, the ISO setting value will change. Set the ISO value one again correctly. The same thing applies to (+) side exposure compensation via ISO 6.

Q: I want to take pictures with the motor cover detached even when I am not shooting with the motor drive, because attaching and detaching it is quite troublesome.

A: The motor cover should always be attached if you are not shooting with the motor drive. It will prevent entry of dust and exposure to direct light.

Q: I took pictures with the aperture ring set at a

halfway position between the f/stop numbers. Was the film properly exposed?

A: Yes, you can use any in-between settings on the aperture ring to obtain precise exposure.

Q: Can I set shutter speed to a position halfway between settings?

A: No, the ring has to be clicked into place.

Q: In the finished print, a peripheral portion of the picture is cut, though I framed it inside the viewfinder.

A: In some color prints and color slides, a peripheral portion of the picture may be eliminated in the laboratory. It is recommended, therefore, to leave some margin in composing your picture.

Q: How do I clean the camera and lens?

A: Clean the camera using a clean, soft lintless cotton cloth. Clean the lens only with a hand powered air blower, antistatic brush or lens tissue. NEVER rub the

QUESTIONS AND ANSWERS (3)

lens surfaces with your finger, clothing or other abrasive material.

Take care not to permit water to enter the camera when taking pictures in the rain or snow, especially near seawater spray. After use near the ocean, wipe the camera surfaces clean and never leave salt residue on the camera.

Q: Is spot metering possible in the flash mode?

A: No, spot metering is not possible.

Q: I want to use a flash that is not of the T-series and F280.

A: Set the flash mode to X and select a shutter speed. The flash synchronization range is B.1~1/60 sec. The flash ready signal and correct exposure confirmation will not turn on in the viewfinder. Read the instruction manual of your flash carefully before using it.

Other cautions

- The Recordata Backs 1 and 2 cannot be used.
- The shutter speed range that can be used for motor drive continuous shooting is 1/2 ~ 1/2000 sec.
- The Motor Drive Socket Cap on the camera side cannot be stored in the Motor Drive 1 or Winders 1 and 2.
- If you want to use a polarizing filter, always use a circularly polarizing filter. If other filters are used, exposure may vary in the case of spot metering.

Description of Controls



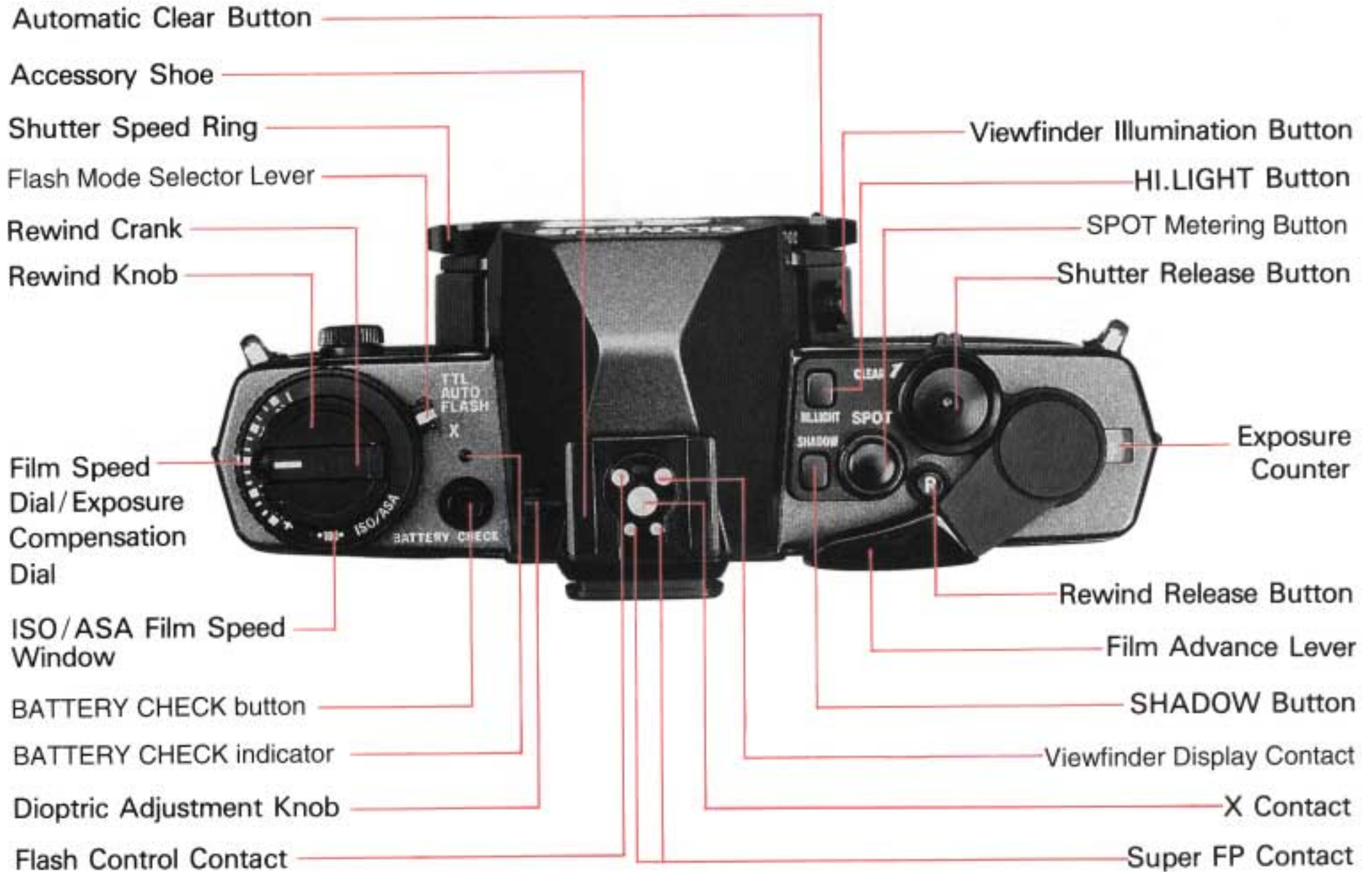

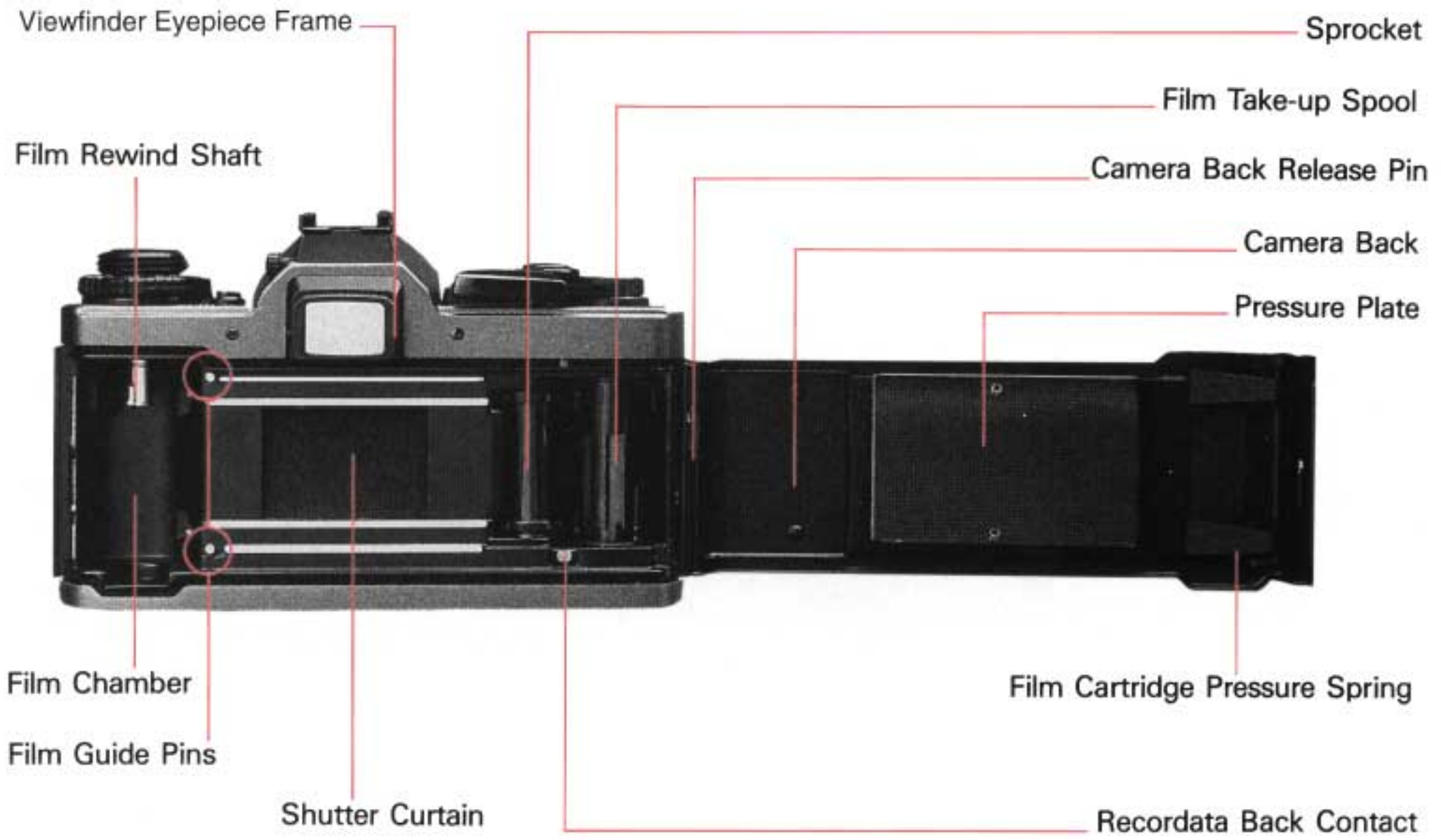

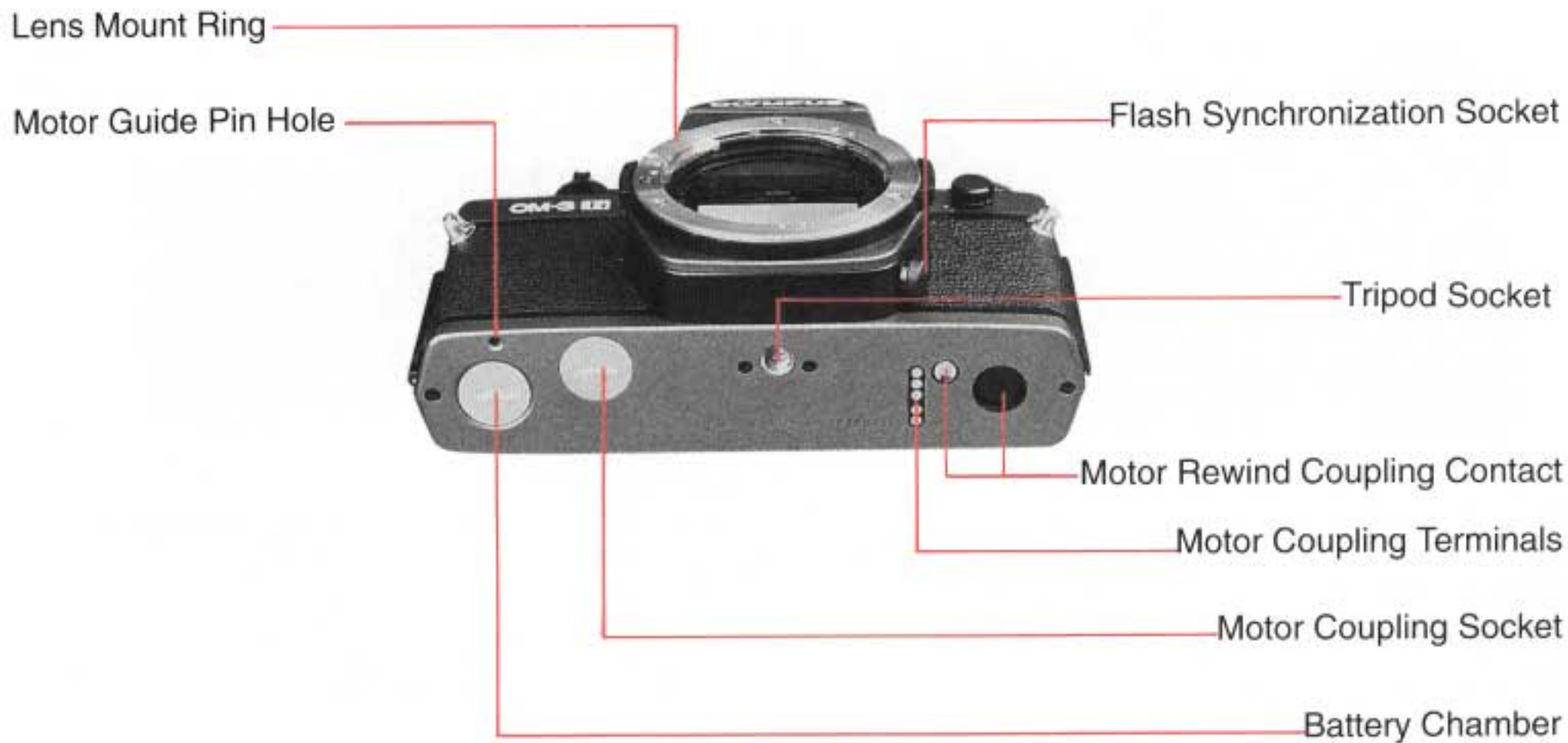

SPECIFICATIONS

Type: Mechanical shutter 35mm SLR camera.

Film format: 24mm × 36mm.

Lens mount: Olympus OM mount.

Shutter: Mechanically controlled cloth focal plane shutter (horizontal action).

Light metering method: Center-weighted average light metering, switchable to spot metering; spot metering selectable in 3 modes — multi-spot, highlight-based and shadow-based methods.

Light metering range: 0 EV ~ 19 EV (ISO 100, 50mm F1.2).

Shutter speed range: B-1 ~ 1/2000 sec. (mechanically controlled).

Flash exposure control: TTL AUTO FLASH (OTF auto flash) mode: OTF auto flash emission (with T-Series or F280 flash) — synchronizes with 1/60 sec. or slower shutter speed. Super FP emission (with F280 flash) — synchronizes with 1/60 ~ 1/2000 sec. X mode: Super FP emission (with F280 flash) — synchronizes with 1/60 ~ 1/2000 sec. Manual (with T-Series or F280 flash) — synchronizes with 1/60 sec. or slower shutter speed.

Connection to flash: Hot shoe (X contact, equipped with Super FP contract terminal); 5-pin connector for T-Series flash; synchro socket.

Film speed: ISO 6 ~3200.

Film advance: Film advance lever with 130° angle for one long or several short strokes and pre-advance angle 30°; motor drive and winder usable.

Viewfinder: With dioptic correction; dioptic correction range +1.0 ~ -3.0 diopters; interchangeable focusing screens; microprism/split image-matte type screen standardized; finder view field: 97% of actual picture field; magnification 0.84X at infinity with -0.5 diop. and 50mm lens.

Viewfinder information: LCD multi-mode display (60-sec. limiter); built-in illuminator (10-sec. limiter).

Battery check: 3-level display with LED and alarm sound.

Power source: Two silver oxide batteries SR44, two alkaline manganese batteries LR44 or one lithium battery CR-1/3N.

Camera back: Removable hinge type, with memo holder; interchangeable with Recordata Back 4

Dimensions: 136 × 84 × 50 mm
(5.4 × 3.3 × 2.0 in.) (body alone).

Weight: 510 g (18 oz.) (body alone).

SPECIFICATIONS, DESIGN AND ACCESSORIES ARE SUBJECT TO CHANGE WITHOUT ANY NOTICE OR OBLIGATION ON THE PART OF THE MANUFACTURER.

■ OTHERS ■

Serial No.

Serial No.

Serial No.

Serial No.

Serial No.

Serial No.

■ MEMO ■



OLYMPUS®

OLYMPUS OPTICAL CO., LTD.

San-Ei Building, 22-2, Nishi Shinjuku 1-chome, Shinjuku-ku, Tokyo, Japan. Tel. 03-3340-2211

OLYMPUS AMERICA INC.

Two Corporate Center Drive, Melville, NY 11747-3157, U.S.A. Tel. 516-844-5000

OLYMPUS OPTICAL CO. (EUROPA) GMBH.

(Premises/Goods delivery) Wendenstrasse 14-16, 20097 Hamburg, Germany. Tel. 040-237730

(Letters) Postfach 10 49 08, 20034 Hamburg, Germany.

OLYMPUS OPTICAL CO. (U.K.) LTD.

2-8 Honduras Street, London EC1Y 0TX, United Kingdom. Tel. 0171-253-2772